

DENON

DJ MIXER

DN-X800

OPERATING INSTRUCTIONS
BEDIENUNGSANLEITUNG

MODE D'EMPLOI

INSTRUCCIONES DE OPERACION

GEBRUIKSAANWIJZING
BRUKSANVISNING

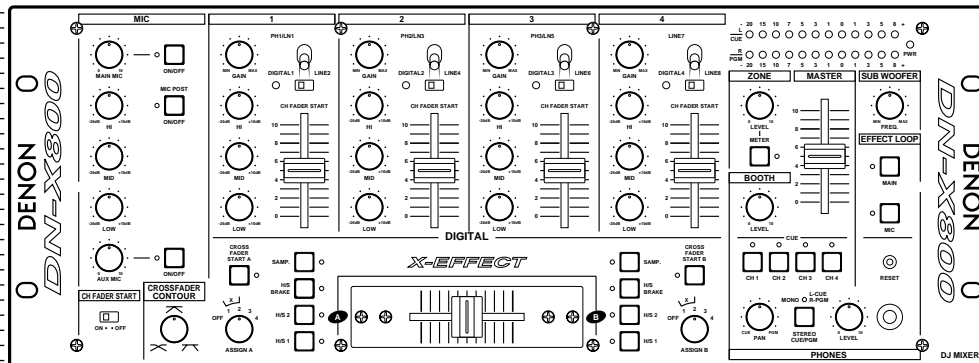

| | | | |
|------------------------------|--------|-------------|----|
| FOR ENGLISH READERS | PAGE | 4 ~ PAGE | 9 |
| FÜR DEUTSCHE LESER | SEITE | 10 ~ SEITE | 15 |
| POUR LES LECTEURS FRANCAIS | PAGE | 16 ~ PAGE | 21 |
| PARA LECTORES DE ESPAÑOL | PAGINA | 22 ~ PAGINA | 27 |
| VOOR NEDERLANDSTALIGE LEZERS | PAGINA | 28 ~ PAGINA | 33 |
| FOR SVENSKA LÄSARE | SIDA | 34 ~ SIDA | 39 |



CAUTION
RISK OF ELECTRIC SHOCK
DO NOT OPEN



CAUTION: TO REDUCE THE RISK OF ELECTRIC SHOCK, DO NOT REMOVE COVER (OR BACK). NO USER SERVICEABLE PARTS INSIDE. REFER SERVICING TO QUALIFIED SERVICE PERSONNEL.



The lightning flash with arrowhead symbol, within an equilateral triangle, is intended to alert the user to the presence of uninsulated "dangerous voltage" within the product's enclosure that may be of sufficient magnitude to constitute a risk of electric shock to persons.



The exclamation point within an equilateral triangle is intended to alert the user to the presence of important operating and maintenance (servicing) instructions in the literature accompanying the appliance.

WARNING: TO PREVENT FIRE OR SHOCK HAZARD, DO NOT EXPOSE THIS APPLIANCE TO RAIN OR MOISTURE.

CAUTION:

1. Handle the power supply cord carefully

Do not damage or deform the power supply cord. If it is damaged or deformed, it may cause electric shock or malfunction when used. When removing from wall outlet, be sure to remove by holding the plug attachment and not by pulling the cord.

2. Do not open the top cover

In order to prevent electric shock, do not open the top cover.

If problems occur, contact your DENON dealer.

3. Do not place anything inside

Do not place metal objects or spill liquid inside the DJ mixer.

Electric shock or malfunction may result.

Please, record and retain the Model name and serial number of your set shown on the rating label.

Model No. DN-X800 Serial No. _____

• DECLARATION OF CONFORMITY

We declare under our sole responsibility that this product, to which this declaration relates, is in conformity with the following standards:

EN60065, EN55013, EN55020, EN61000-3-2 and EN61000-3-3.

Following the provisions of 73/23/EEC, 89/336/EEC and 93/68/EEC Directive.

• ÜBEREINSTIMMUNGSEKTLÄRUNG

Wir erklären unter unserer Verantwortung, daß dieses Produkt, auf das sich diese Erklärung bezieht, den folgenden Standards entspricht:

EN60065, EN55013, EN55020, EN61000-3-2 und EN61000-3-3.

Entspricht den Verordnungen der Direktive 73/23/EEC, 89/336/EEC und 93/68/EEC.

• DECLARATION DE CONFORMITE

Nous déclarons sous notre seule responsabilité que l'appareil, auquel se réfère cette déclaration, est conforme aux standards suivants:

EN60065, EN55013, EN55020, EN61000-3-2 et EN61000-3-3.

D'après les dispositions de la Directive 73/23/EEC, 89/336/EEC et 93/68/EEC.

• DECLARACIÓN DE CONFORMIDAD

Declaramos bajo nuestra exclusiva responsabilidad que este producto al que hace referencia esta declaración, está conforme con los siguientes estándares:

EN60065, EN55013, EN55020, EN61000-3-2 y EN61000-3-3.

Siguiendo las provisiones de las Directivas 73/23/EEC, 89/336/EEC y 93/68/EEC.

• EENVORMIGHEIDSVERKLARING

Wij verklaren uitsluitend op onze verantwoordelijkheid dat dit product, waarop deze verklaring betrekking heeft, in overeenstemming is met de volgende normen:

EN60065, EN55013, EN55020, EN61000-3-2 en EN61000-3-3.

Volgens de bepalingen van de Richtlijnen 73/23/EEC, 89/336/EEC en 93/68/EEC.







• ÖVERENSSTÄMMELSEINTYG

Härmed intygas helt på eget ansvar att denna produkt, vilken detta intyg avser, uppfyller följande standarder:

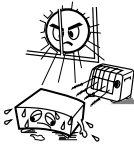
EN60065, EN55013, EN55020, EN61000-3-2 och EN61000-3-3.

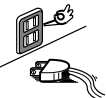
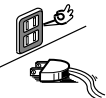
Enligt stadgarna i direktiv 73/23/EEC, 89/336/EEC och 93/68/EEC.

**NOTE ON USE / HINWEISE ZUM GEBRAUCH /
OBSERVATIONS RELATIVES A L'UTILISATION / NOTAS SOBRE EL USO /
ALVORENS TE GEBRUIKEN / OBSERVERA**

| | | |
|--|---|--|
|  <ul style="list-style-type: none"> • Avoid high temperatures. Allow for sufficient heat dispersion when installed on a rack. • Vermeiden Sie hohe Temperaturen. Beachten Sie, daß eine ausreichend Luftzirkulation gewährleistet wird, wenn das Gerät auf ein Regal gestellt wird. • Eviter des températures élevées. Tenir compte d'une dispersion de chaleur suffisante lors de l'installation sur une étagère. • Evite altas temperaturas. Permite la suficiente dispersión del calor cuando está instalado en la consola. • Vermijd hoge temperaturen. Zorg voor een degelijk hitteafvoer indien het apparaat op een rek wordt geplaatst. • Undvik höga temperaturer. Se till att det finns möjlighet till god värmeavledning vid monterig i ett rack. |  <ul style="list-style-type: none"> • Keep the set free from moisture, water, and dust. • Halten Sie das Gerät von Feuchtigkeit, Wasser und Staub fern. • Protéger l'appareil contre l'humidité, l'eau et la poussière. • Mantenga el equipo libre de humedad, agua y polvo. • Laat geen vochtigheid, water of stof in het apparaat binnendringen. • Utsätt inte apparaten för fukt, vatten och damm. |  <ul style="list-style-type: none"> • Do not let foreign objects in the set. • Keine fremden Gegenstände in das Gerät kommen lassen. • Ne pas laisser des objets étrangers dans l'appareil. • No deje objetos extraños dentro del equipo. • Laat geen vreemde voorwerpen in dit apparaat vallen. • Se till att främmande föremål inte tränger in i apparaten. |
|  <ul style="list-style-type: none"> • Do not let insecticides, benzene, and thinner come in contact with the set. • Lassen Sie das Gerät nicht mit Insektiziden, Benzin oder Verdünnungsmitteln in Berührung kommen. • Ne pas mettre en contact des insecticides, du benzène et un diluant avec l'appareil. • No permita el contacto de insecticidas, gasolina y diluyentes con el equipo. • Laat geen insektenverdelgende middelen, benzine of ververdunner met dit apparaat in contact komen. • Se till att inte insektsmedel på spraybruk, bensen och thinner kommer i kontakt med apparatens hölje. |  <ul style="list-style-type: none"> • Unplug the power cord when not using the set for long periods of time. • Wenn das Gerät eine längere Zeit nicht verwendet werden soll, trennen Sie das Netzkabel vom Netzstecker. • Débrancher le cordon d'alimentation lorsque l'appareil n'est pas utilisé pendant de longues périodes. • Desconecte el cordón de energía cuando no utilice el equipo por mucho tiempo. • Neem altijd het netsnoer uit het stopcontact wanneer het apparaat gedurende een lange periode niet wordt gebruikt. • Koppla ur nätkabeln om apparaten inte kommer att användas i lång tid. |  <ul style="list-style-type: none"> • Do not let insecticides, benzene, and thinner come in contact with the set. • Lassen Sie das Gerät nicht mit Insektiziden, Benzin oder Verdünnungsmitteln in Berührung kommen. • Ne pas mettre en contact des insecticides, du benzène et un diluant avec l'appareil. • No permita el contacto de insecticidas, gasolina y diluyentes con el equipo. • Laat geen insektenverdelgende middelen, benzine of ververdunner met dit apparaat in contact komen. • Se till att inte insektsmedel på spraybruk, bensen och thinner kommer i kontakt med apparatens hölje. |
|  <ul style="list-style-type: none"> • Handle the power cord carefully. Hold the plug when unplugging the cord. • Gehen Sie vorsichtig mit dem Netzkabel um. Halten Sie das Kabel am Stecker, wenn Sie den Stecker herausziehen. • Manipuler le cordon d'alimentation avec précaution. Tenir la prise lors du débranchement du cordon. • Maneje el cordón de energía con cuidado. Sostenga el enchufe cuando desconecte el cordón de energía. • Hanteer het netsnoer voorzichtig. Houd het snoer bij de stekker vast wanneer deze moet worden aan- of losgekoppeld. • Hantera nätkabeln varsamt. Håll i kabeln när den kopplas från el-uttaget. |  <p>* (For sets with ventilation holes)</p> <ul style="list-style-type: none"> • Do not obstruct the ventilation holes. • Die Belüftungsoffnungen dürfen nicht verdeckt werden. • Ne pas obstruer les trous d'aération. • No obstruya los orificios de ventilación. • De ventilatieopeningen mogen niet worden beblokkeerd. • Täpp inte till ventilationsöppningarna. |  <ul style="list-style-type: none"> • Never disassemble or modify the set in any way. • Versuchen Sie niemals das Gerät auseinander zu nehmen oder auf jegliche Art zu verändern. • Ne jamais démonter ou modifier l'appareil d'une manière ou d'une autre. • Nunca desarme o modifique el equipo de ninguna manera. • Nooit dit apparaat demonteren of op andere wijze modifieren. • Ta inte isär apparaten och försök inte bygga om den. |

**FRONT PANEL DIAGRAM / VORDERES BEDIENFELD-SCHEMA /
SCHEMA DU PANNEAU AVANT / DIAGRAMA DEL PANEL FRONTAL /
OVERZICHT VAN VOORPANEEL / FRONTPANELEN**

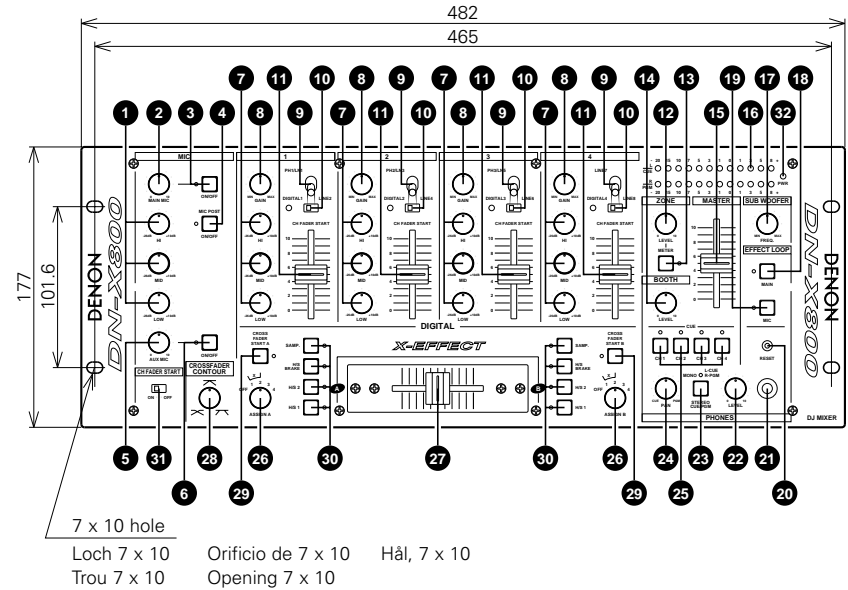

**REAR PANEL DIAGRAM / HINTERES ANSCHLUSSFELD-SCHEMA /
SCHEMA DU PANNEAU ARRIERE / DIAGRAMA DEL PANEL POSTERIOR /
OVERZICHT VAN ACHTERPANEEL / BAKPANELEN**

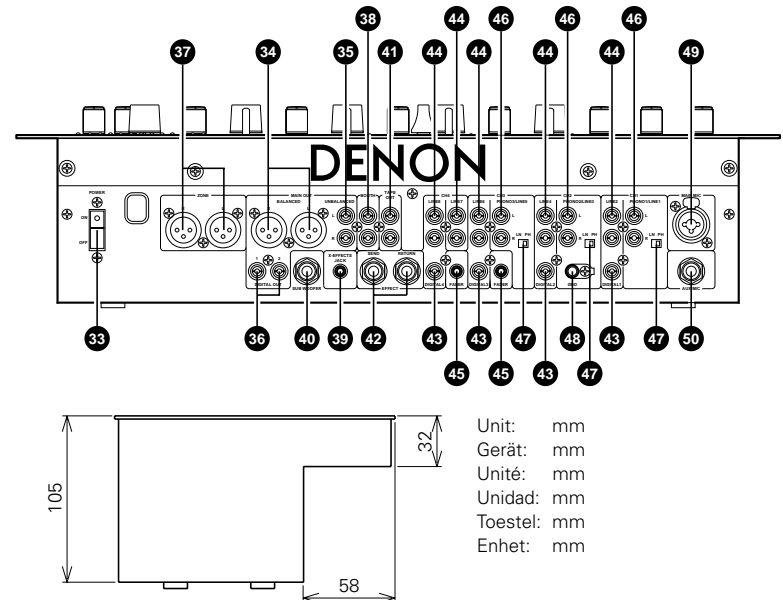

– TABLE OF CONTENTS –

| | | | | | |
|---|--------------------------------|------|---|--------------------------------|---|
| 1 | Main features | 4 | 5 | Fader start | 7 |
| 2 | Installation | 4 | 6 | X-effect | 8 |
| 3 | Part names and functions | 4, 5 | 7 | Replacing the crossfader | 9 |
| 4 | Connections | 6 | 8 | Specifications | 9 |

• ACCESSORIES

Please check to make sure the following items are included with the main unit in the carton:

| | | | | | |
|---|------------------------------|---|---|--|---|
| ① | Operating instructions | 1 | ② | Connection cords (3.5 mm stereo mini cord) | 2 |
|---|------------------------------|---|---|--|---|

1 MAIN FEATURES

CONGRATULATIONS! You have purchased the DENON DN-X800 DJ mixer from DENON.

1. X-Effect

The X-Effect is a unique feature which is designed to work with the DENON DN-2100F and DN-2600F CD players. The fader start of the below functions can be used with the Crossfader. Sampler, Hot start brake/platter, Hot start 1, 2 (each drive).

2. CH. Fader and Crossfader start

The CD player can be started or stopped simply by increasing or decreasing the level of the CH fader or by using the cross fader left to right or right to left. (This function can only be used when the DENON CD players DN-1800F, DN-2100F or DN-2600F is connected to the DN-X800.)

3. Digital outputs

The DN-X800 allows you to record directly to CD-R, MiniDisc or a hard disk device through it's exclusive coaxial digital outputs. The digital outputs maintains a constant 16 bit / 44.1 kHz signal.

4. Digital inputs

The DN-X800 accepts up to 4 digital inputs. Such as our family of performers, DN-1800F, DN-2100F, DN-2600F, DP-DJ151 or any device with a digital output. The sampling frequency range can be 32 kHz, 44.1 kHz or 48 kHz.

5. Enhanced input/output terminals (Analog)

8 Line, 3 Phono, 2 microphone systems, 2 Main outputs, Zone output, Booth output, Sub woofer output and tape output are provided independently. Effect in/out terminals are also provided for a external effects processor.

6. 3-Band equalizer/Gain

Bass, Mid, Treble and Gain controls are available on every input channel.

7. Crossfader contour

This feature allows adjusting the "shape" of the Crossfader response from a gentle curve for smooth, long running fades, to the steep pitch required for top performance cut and scratch effects.

8. Mic post

This feature will pass the Main Mic signal into the Zone, Booth, Tape output and Digital output signal path. In the OFF mode, the MIC signal will not be routed through the above outputs.

2 INSTALLATION

When the DN-X800 is mounted inside a coffin or DJ booth, we recommend leaving a 3 cm blank space above the mixer if possible.

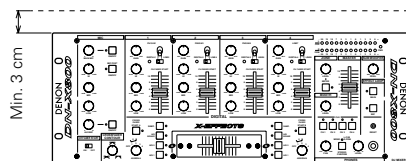

3 PART NAMES AND FUNCTIONS

(1) Front Panel

- ① **MIC EQ controls**
 - Contour the frequency response of the Main Mic input -12 dB to +12 dB.
 - HI**
 - Adjusts high-tone microphone sound -12 dB to +12 dB. At the center position, sound is flat.
 - MID**
 - Adjusts mid-tone microphone sound -12 dB to +12 dB. At the center position, sound is flat.
 - LOW**
 - Adjusts low-tone microphone sound -12 dB to +12 dB. At the center position, sound is flat.
- ② **MAIN MIC level control**
 - Adjusts the level of the Main Mic input.
- ③ **MAIN MIC ON/OFF button**
 - Puts the Main Mic signal into the Main outputs signal path.
 - When the button is pressed, the Main Mic is on and the adjacent orange indicator lights.
- ④ **MIC POST ON/OFF button**
 - Puts the Main Mic signal into the Zone, Booth Tape and Digital out signal path.
 - When the button is pressed, the adjacent green indicator lights.
- ⑤ **AUX MIC level control**
 - Adjusts the level of the Aux Mic input.
- ⑥ **AUX MIC ON/OFF button**
 - Puts the Aux Mic signal into the mixer signal path.
 - When the button is pressed, the Aux Mic is on and the adjacent orange indicator lights.
- ⑦ **Source EQ controls**
 - Contour the frequency response of the selected inputs.
 - HI**
 - Adjusts the high-tone sound -26 dB to +10 dB. At the center position, sound is flat.
 - MID**
 - Adjusts the mid-tone sound -26 dB to +10 dB. At the center position, sound is flat.
 - LOW**
 - Adjusts the low-tone sound -26 dB to +10 dB. At the center position, sound is flat.

NOTE:
Clipping may occur if adjustments are set to harsh.

- ⑧ **GAIN level control**
 - Adjusts the level of the selected input 0 to +10 dB.
- ⑨ **Source input select switch**
 - Selects either a Phono/Line or Line input for the source.

- ⑩ **LINE/DIGITAL input select switch**
 - Selects either a Line (analog) or Digital Input for the Source.
 - The adjacent green indicator flashes when the digital signal is unlocked and remains lit when the digital signal is locked.

NOTE:
You must first set the pitch slider to zero % of the digital output source (CD, MD) before it's power is turned on. If the green digital indicator is flashing on the mixer, please perform the above steps.

- ⑪ **Source input fader (Ch. fader)**
 - Controls the level of the selected Input.
- ⑫ **ZONE level control**
 - Adjusts the level of the Zone outputs.
- ⑬ **ZONE METER button**
 - When this button is pressed down and held, the meter indicates the stereo level in the LEFT and RIGHT meter output. The adjacent green indicator lights.
- ⑭ **BOOTH LEVEL control**
 - Adjusts the level of the Booth outputs.
- ⑮ **MASTER LEVEL fader**
 - Adjusts the level of the Main outputs. Signals from the channels selected with the Assign switches will be output using the Source input fader (Ch. fader) and the Crossfader, while signals from other channels will be outputs using the Source input fader (Ch. fader).
- ⑯ **Peak dB CUE/PROGRAM meter**
 - Displays the output level following Master Level adjustment, the peak level is held for 1 second. Display range : -20 dB to +8 dB.
 - Can switch between two display mode. See below ⑳.
- ⑰ **SUBWOOFER frequency control**
 - Adjusts the cut off frequency of the low pass filter 40 Hz to 200 Hz.
 - The low adjustment, will effect the Subwoofer output.
- ⑱ **EFFECT LOOP MAIN button**
 - Routes the Main signal through the external processor attached to the EFFECT connectors on the rear.
 - When the button is pressed in, the adjacent orange indicator lights. (When the processor isn't attached, indicator blinks.)
- ⑲ **EFFECT LOOP MIC button**
 - Routes the Main Mic signal through the external processor attached to the EFFECT connectors on the rear.
 - When the button is pressed in, the adjacent orange indicator lights. (When the processor isn't attached, indicator blinks.)

NOTE:
When the Effect Loop Main and Mic are on, the signal of Mic is output to all the outputs regardless of setting the Main Mic and the Post Mic.

20 RESET switch

- Returns to initial settings when this switch is pressed.

21 HEADPHONE output jack

- Accepts 1/4" stereo headphone plugs.

22 HEADPHONE level control

- Adjusts the volume for the headphones.

23 HEADPHONE mode button

- In the STEREO mode, this button feeds STEREO Program and Cue to both earcups, in the MONO mode, the Headphone circuit provides MONO Cue to the left ear and MONO Program to the right.
- In the STEREO mode, the meter indicates the stereo level in the LEFT and RIGHT Main Outputs. In the MONO mode, mono CUE level is displayed on the Left meter and mono PROGRAM level is displayed on the Right meter.
- In the MONO mode, the adjacent green indicator lights.

24 HEADPHONE PAN control

- Serves two purposes...In the STEREO mode it changes the relative levels of the Cue and Program mixed together in both earcups. In the MONO mode it changes the balance between the Mono Cue in the left ear cup and the Mono Program in the right.

25 CUE buttons

- Pressing in any or all of the CUE buttons routes the respective Source to the Headphone and Meter Cue sections. Pressing multiple buttons makes it possible to derive mixed sound from the selected sources. The adjacent red indicator illuminates when the button is depressed.

26 CROSSFADE ASSIGN A, B switches

- Assigns the Crossfader to any of the four Input Channels and Off.

OFF

Select when not using the crossfader.

1 to 4

Select what channels (CH-1 to CH-4) to assign to A and B.

Channels not assigned to A or B are output without passing through the crossfader.

27 CROSSFADER

- Controls the relative output level from the summed A and B Mixes. When the fader is at its far left, only the A Mix is heard from the Outputs. As the fader is moved toward the right, the amount of B Mix is increased and the amount of A Mix is decreased. When the fader is centered, equal amounts of A and B Mixes are routed to the Outputs. Fully right is all B Mix at the Outputs.

28 CROSSFADER CONTOUR control

- Allows adjusting the "shape" of the Crossfader response from a gentle curve for smooth, long running fades, to the steep pitch required for top performance cut and scratch effects.

29 CROSSFADER START A, B buttons

- The function to start the performance of CD Player with Crossfader automatically is turned on/off.
- When the button is pressed in, the Crossfader Start is on and the adjacent orange indicator lights.

30 X-EFFECT function buttons

- The Fader Start is executed by connecting the Expansion Jack of the RC of the DN-2100F and the DN-2600F, the item that is executed by Crossfader and Ch. fader are selected by the button in each Ch.. It is not possible to use when the RC is not connected.

SAMP. buttons

This function will start the Sampler of the DN-2600F by using Crossfader and Ch. fader are turned on/off.

H/S BRAKE buttons

This button provides 2 functions, Brake and Platter-S. You first need to load a Hot Start(s) to activate this feature.

By pressing either H/S Brake button once, will activate H/S Brake mode (orange indicator is lit) .

By pressing the same button once more, this will activate H/S Platter-S mode (indicator is flashing).

A third press will turn this function OFF.

See "X-EFFECT" to use this feature on page 8.

H/S 1, 2 buttons

This function will start the Hot Start of the DN-2100F and the DN-2600F by using Crossfader and Ch. fader are turned on/off.

31 CH. FADER START switches

- This function will start the performance of CD Player with Ch. fader automatically is turned on/off.

32 POWER indicator

- When the red indicator is lit, the DN-X800 is ready to go.

(2) Rear Panel**33 POWER switch**

- Press the switch to turn the power on.

34 MAIN OUT (BALANCED) connectors

- These XLR type connectors provide a balanced line level output.
- Connect these connectors to the balanced analog input connectors on an amplifier or console.
- Pin layout 1. Common 2. Hot 3. Cold
- Applicable connector: Cannon XLR-3-31 or equivalent.

NOTE:

Do not short-circuit the hot or cold pin with the common pin.

35 MAIN OUT (UNBALANCED) jacks

- This stereo pair of RCA jacks provide a unbalanced line level output.
- Connect these jacks to the unbalanced analog input jacks on an amplifier or console.

36 DIGITAL OUT 1, 2 jacks

- These RCA jacks provide a digital output data. The signal is unaffected by the Master Level fader. Output is controlled by Ch. fader volume.
- We recommend using a 75Ω/ohm RCA cord for best digital transfer. (available from any audio/video retailer)

37 ZONE OUT (BALANCED) connectors

- These XLR type connectors provide a balanced line level output with independent front panel Zone Level controls and are not affected by the Master Level control.
- Connect these connectors to the balanced analog input connectors on an amplifier or console.
- Pin layout 1. Common 2. Hot 3. Cold
- Applicable connector: Cannon XLR-3-31 or equivalent.

NOTE:

Do not short-circuit the hot or cold pin with the common pin.

38 BOOTH OUT jacks

- This stereo pair of RCA jacks provide a unbalanced line level output with independent front panel Booth Level controls and are not affected by the Master Level control.
- Connect these jacks to the unbalanced analog input jacks on an amplifier or console.

39 X-EFFECTS JACK

- Connect this jack to the remote of the DN-2100F and the DN-2600F using the 3.5 mm stereo mini cord.

40 SUBWOOFER output jack

- This 1/4" mono jacks provide a mono line level output of Main Out. The signal is affected by the Master Level fader.
- Connect this jacks to the subwoofer input jack on an amplifier.

41 TAPE OUT jacks

- This stereo pair of RCA jacks provide a line level output. The signal is unaffected by the Master Level fader. Output is controlled by Ch. fader volume.
- It is intended for use with a tape recorder, but is not restricted to that purpose. Output is controlled by Ch. fader volume.

42 EFFECT jacks

- These 1/4" stereo jacks allow stereo external processing of the Program signal.
- These are switching jacks — always complete the loop when connecting a send and return, or no sound will be heard.

43 DIGITAL 1, 2, 3, 4 input jacks

- These RCA jacks are Inputs for any digital output device.
- We recommend using a 75Ω/ohm RCA cord for best digital transfer. (available from any audio/video retailer)

44 LINE 2, 4, 6, 7, 8 input jacks

- These stereo pairs of unbalanced RCA jacks are Inputs for any line level device.

45 Ch 3, 4 FADER output jacks

- Connect these jacks to the Fader input jacks of the DN-1800F, the DN-2100F and the DN-2600F using the 3.5 mm stereo mini cord.

46 PHONO 1, 2, 3 / LINE 1, 3, 5 input jacks

- These stereo pairs of unbalanced RCA jacks are Inputs for a Phono (RIAA) stage for magnetic (MM) cartridges or a Line stage suitable for any device, such as a CD player.

47 PHONO 1, 2, 3 / LINE 1, 3, 5 switches

- These switches change the Input from Phono to a Line level inputs.
- These switches set a Line level inputs when Turntable is not connected.

48 Phono Ground screw

- This screws provide a place to connect the ground wire from a turntable. This terminal is exclusively for a turntable grounding and not a safety earth ground.

49 MAIN MIC input connector

- Neutrik combo jack.
- Accepts either a balanced microphone with an XLR connector or an unbalanced microphone with 1/4" mono jacks.

50 AUX MIC input jack

- Accepts an unbalanced microphone with 1/4" mono jacks.

5 FADER START

If the separately sold DN-1800F, DN-2100F and DN-2600F players are connected to CH-3 or CH-4, they can be started using the source input fader (Ch. fader) or Crossfader, as long as the 3.5 mm stereo mini cords have been connected.

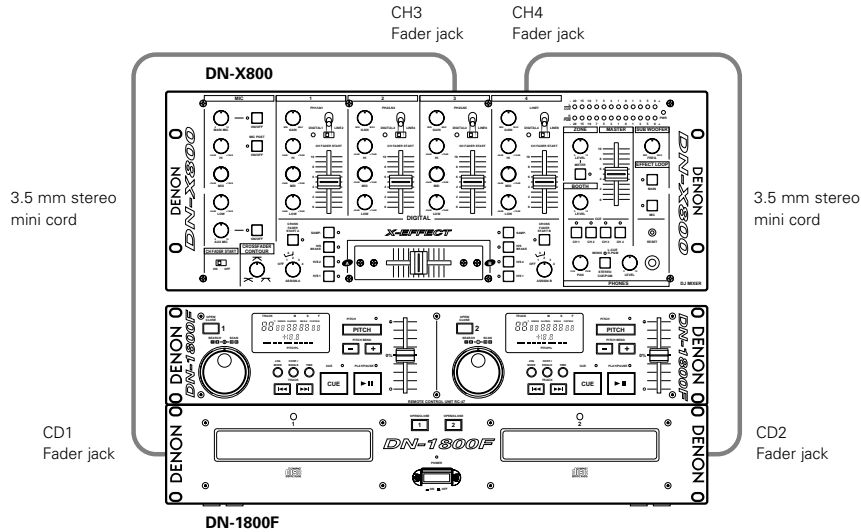

NOTE:
Use the analog inputs/outputs when the DN-1800F, the DN-2100F and the DN-2600F are moved by FADER START.

Channel Fader Start

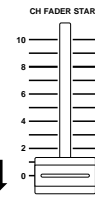
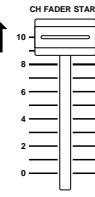
- 1 Turn on the Ch. fader start switch.
 
- 2 Move the source input fader (Ch. fader) of CH-3 or Ch-4 control all the way to the bottom.
 
- 3 **DN-1800F**
Set the cue point on either drive.
DN-2100F and DN-2600F
Set the A-1 or A-2 point on either drive.
- 4 When you want to start the player, move up the source input fader (Ch. fader) and the CD player will begin playing.
 

- NOTES:**
- Channels selected with the Crossfader Assign A, B switches and the Crossfader Start A, B buttons cannot be started with the source input fader (Ch. fader).
 - Ch. Fader Start and Cross Fader Start for the same source will not operate simultaneously. You must select from either one. If both Ch. Fader and Cross Fader switches are ON, priority will be the cross fader.

Crossfader Start

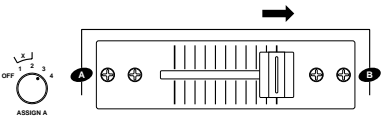
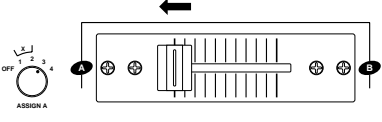
- 1 Using the Crossfader Assign A, B switches, select the channel (CH-3 or CH-4) that the CD player is connected.
- 2 Press the Crossfader Start A, B buttons of the channel connected to the CD player to be controlled.
- 3 Slide the Crossfader all the way in direction opposite the source you want to start. (In the following example, startup is done with the CD player connected to CH-3 set to Assign A.)
 
- 4 **DN-1800F**
Set the cue point on the left drive.
DN-2100F and DN-2600F
Set the A-1 or A-2 point on the left drive.
- 5 Use the Crossfader Contour control to control the cross fader startup curve.
- 6 When the Crossfader is slid in the opposite direction as in "3", CD player play will begin.
 

6 X-EFFECT

If the separately sold DN-2100F and DN-2600F players are connected below, they can be started using the source input fader (Ch. fader) or Crossfader.

The below function can be started using the source input fader (Ch. fader) or Crossfader by setting it with CD PLAYER.

Sampler (DN-2600F), Hot Start Brake Platter (DN-2100F and DN-2600F), Hot Start (DN-2100F and DN-2600F)

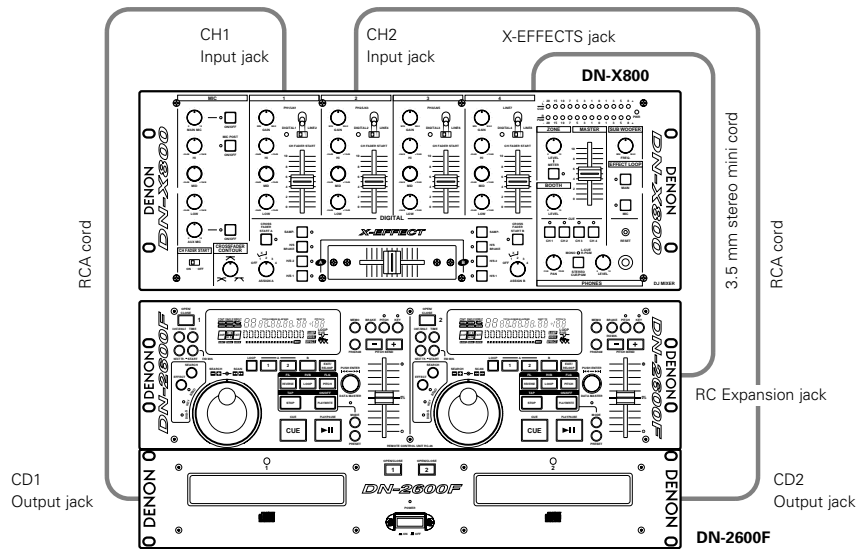

NOTE:
Use the analog inputs/outputs when the DN-2600F and the DN-2100F are moved by X-EFFECT.

(1) Selecting the mode

Sampler (DN-2600F)

- 1 The sound for the Sampler is recorded with the DN-2600F.
 - When the sound is recorded, the adjacent green indicator lights.
- 2 Press the SAMP. button.

Hot Start (DN-2100F and DN-2600F)

- 1 Set the Hot Start 1 and/or 2 point of the CD player.
 - When set the Hot Start point, the adjacent orange indicator lights.
- 2 Press the H/S 1, 2 button.

Hot Start Brake Platter (DN-2100F and DN-2600F)

- 1 Press the H/S BRAKE button, and the adjacent orange indicator lights.

The function for the Brake stop is done by using Crossfader and source input fader. (Ch. fader) Ch Fader must be set and left in the up position.

The indicator of H/S 1, 2 and SAMP. change automatically if Assign switches are changed to CH-1 or CH-2.

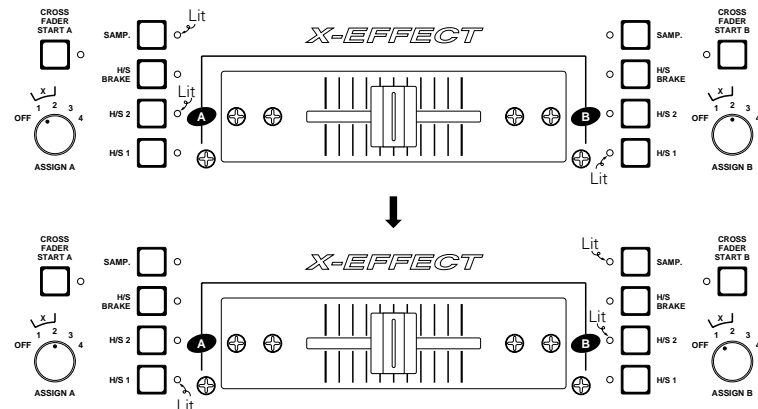

(2) Starting with Fader Start

Channel Fader Start

- 1 Turn on the Ch. fader start switch.
- 2 Move the source input fader (Ch. fader) of CH-1 or CH-2 control all the way to the bottom.
- 3 When you want to start the player, move up the source input fader (Ch. fader) and the CD player will begin playing.

NOTES:

- Channels selected with the Crossfader Assign A, B switches and the Crossfader Start A, B buttons cannot be started with the source input fader (Ch. fader).
- Ch. Fader Start and Cross Fader Start for the same source will not operate simultaneously. You must select from either one. If both Ch. Fader and Cross Fader switches are ON, priority will be the cross fader.

Crossfader Start

- 1 Using the Crossfader Assign A B switches, select the channel (CH-1 or CH-2) that the CD player is connected.
- 2 Press the Crossfader Start A, B buttons of the channel connected to the CD player to be controlled.
- 3 Slide the Crossfader all the way in direction opposite the source you want to start. (In the following example, startup is done with the CD player connected to CH-1 set to Assign A.)
- 4 Use the Crossfader Contour control to control the cross fader startup curve.
- 5 When the Crossfader is slid in the opposite direction as in "3", CD player will begin.

NIPPON COLUMBIA CO., LTD.

14-14, AKASAKA 4-CHOME, MINATOKU, TOKYO 107-8011, JAPAN
Telephone: (03) 3584-8111