

HEADRUSH[®]

FRFR-GO

User Guide
English



(1.0) Introduction 3

 (1.1) Box Contents3

 (1.2) Support.....3

(2.0) Important Safety Precautions..... 3

(3.0) Battery Charging..... 4

(4.0) Setup 5

 (4.1) Quick Start.....5

 (4.2) Example A: One FRFR-GO (Mono)5

 (4.3) Example B: Two FRFR-GOs (Stereo)..... 6

 (4.4) Example C: One FRFR-GO (Stereo) AUX Input..... 6

(5.0) Features 7

 (5.1) Rear Panel.....7

 (5.2) Front Panel8

(6.0) Operation..... 9

 (6.1) Pairing a Bluetooth Device..... 9

(7.0) Troubleshooting.....10

(8.0) Appendix11

 (8.1) Technical Specifications..... 11

 (8.2) Trademarks & Licenses 11

(1.0) Introduction

Note: Before you first use the product, please fully charge the batteries. For optimal charging, power off the speaker while charging.

Use the included power cable to connect the unit to a power outlet and let it charge for up to 3 hours. This helps ensure the longest life for your battery.

(1.1) Box Contents

FRFR-GO

Power Cable

Quickstart Guide

Safety & Warranty Manual

(1.2) Support

For the latest information about this product (documentation, technical specifications, system requirements, compatibility information, etc.) and product registration, visit headrushfx.com.

For additional product support, visit support.headrushfx.com.

(2.0) Important Safety Precautions

Please note: HeadRush and inMusic are not responsible for the use of its products or the misuse of this information for any purpose. HeadRush and inMusic are not responsible for the misuse of its products caused by avoiding compliance with inspection and maintenance procedures. Please refer to the included safety and warranty manual for more information.

 **Caution:** To reduce the risk of electric shock, do not connect a FRFR-GO to a power outlet while the grille is removed.

Danger: Mounting of any heavy load can result in serious injury and equipment damage. This work should be done by qualified persons following safe mounting practices in accordance with all applicable safety and construction standards. Such persons must determine the required load ratings and design factors. They must determine the mounting method that meets static, dynamic, shock, and any other load requirements. All such work must be done in accordance with and in compliance with all federal, state, and local regulations governing such work.

(3.0) Battery Charging

For the quickest charging time, power off FRFR-GO and use the included power cable to connect the unit to a power outlet. A full charge can take up to 3 hours.

The **charge LED** will illuminate with a corresponding color to show how much battery life is left.

- When the battery power has between 15%-100% left, the LED will be lit green.
- When the battery power has between 5%-15% left, the LED will be lit red.
- When the battery power is less than 5%, the unit will shut down.

Here are some other recommendations for getting the longest life from the internal battery.

General Usage Fully charge the battery before using it.

Avoid full discharge of the battery if possible. Li-Ion batteries are maintenance-free, and the battery will last longest when operating between 30 and 80 percent charged.

Do not charge the battery in exceedingly hot (greater than 90°F/32°C) or exceedingly cold (less than 32°F/0°C) temperatures.

Storage For best product longevity, do not store at exceedingly hot (greater than 90°F/32°C) or exceedingly cold (less than 32°F/0°C) temperatures.

For best product longevity, store product with a 50% battery charge.

If you leave the battery level low and do not charge it for 6 months, it may permanently lose capacity.

Repair If the battery fails to charge, contact HeadRush at support.headrushfx.com.

Disposal Bring the unit to a recycling center or dispose of in accordance with local ordinances.

(4.0) Setup

(4.1) Quick Start

1. While the power is switched off, plug the included power cable into FRFR-GO, then plug the cable into a power outlet.
2. Connect audio input sources (smartphone, tablet, etc.) to FRFR-GO. For best results, do not connect a guitar directly to FRFR-GO's input as the circuitry is designed to only be connected to an amp modeler's line output.
3. Connect audio output devices (headphones, amp modeling pedal, etc.) to FRFR-GO. To avoid unwanted distortion, set the output of your amp modeler's line-level output as close to unity gain (0 dB) without going over. For HeadRush modelers, set their main volume knob around "7", depending on your rig's setup. If you are unsure of where the unity gain position of your amp modeler is, check your amp modeler's User Guide.
4. Power on your connected audio devices, *then* power on FRFR-GO.
5. Turn up the volume on your connected **Bluetooth** device, **Aux** input device, or instrument **Input** source.
6. Adjust the **Input Volume knob** on FRFR-GO to an appropriate level.
7. Finally, adjust the **Main Volume** on FRFR-GO to an appropriate level.

(4.2) Example A: One FRFR-GO (Mono)

Items not listed under [\(1.1\) Introduction > Box Contents](#) are sold separately.

Connect the Left (Mono) output of your guitar or bass multi-FX/amp modeling pedal to the input on a FRFR-GO.

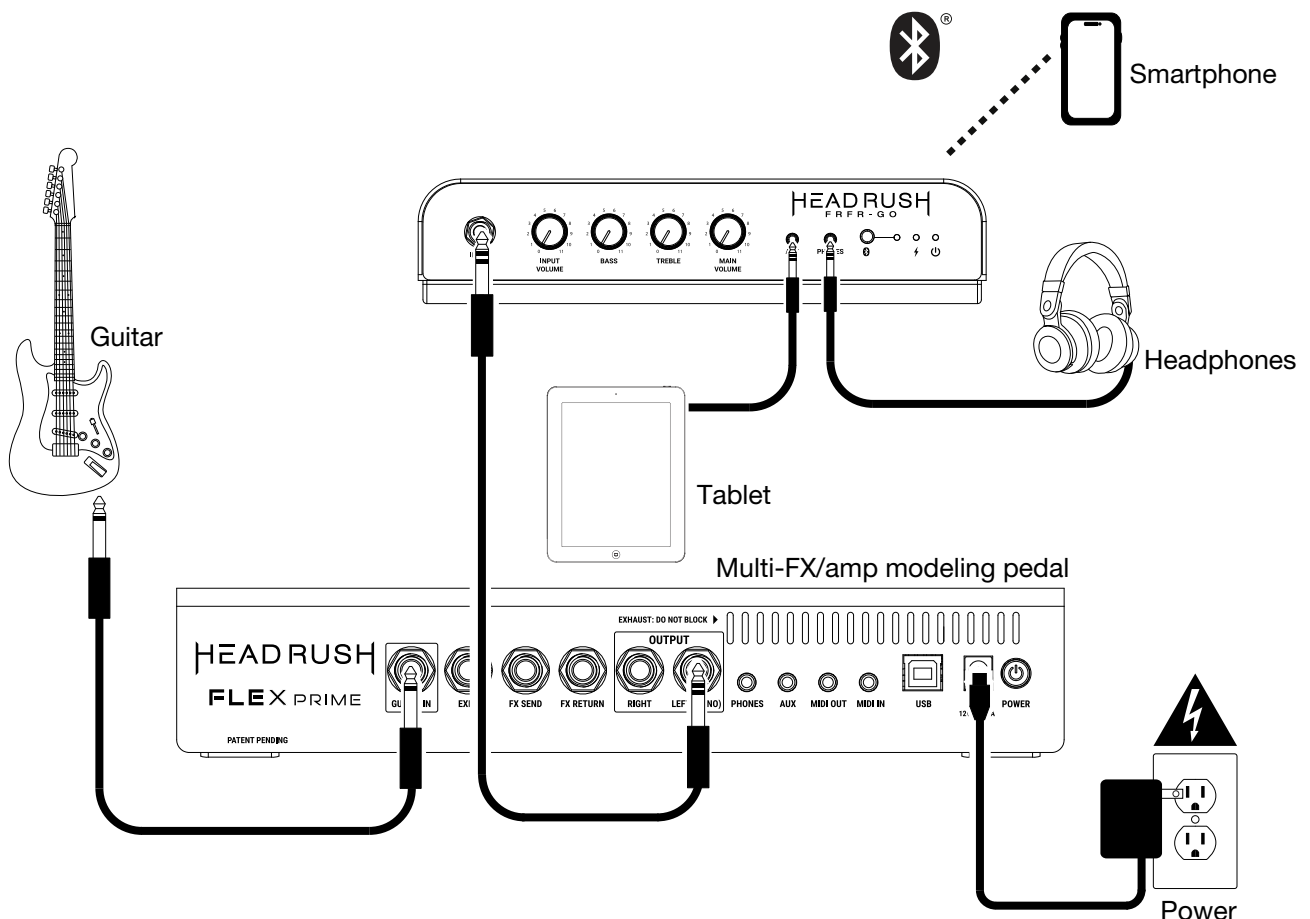

(4.3) Example B: Two FRFR-GOs (Stereo)

Items not listed under [\(1.1\) Introduction > Box Contents](#) are sold separately.

Connect the Right and Left (Mono) outputs of your or guitar bass multi-FX/amp modeling pedal to the inputs of your FRFR-GO.

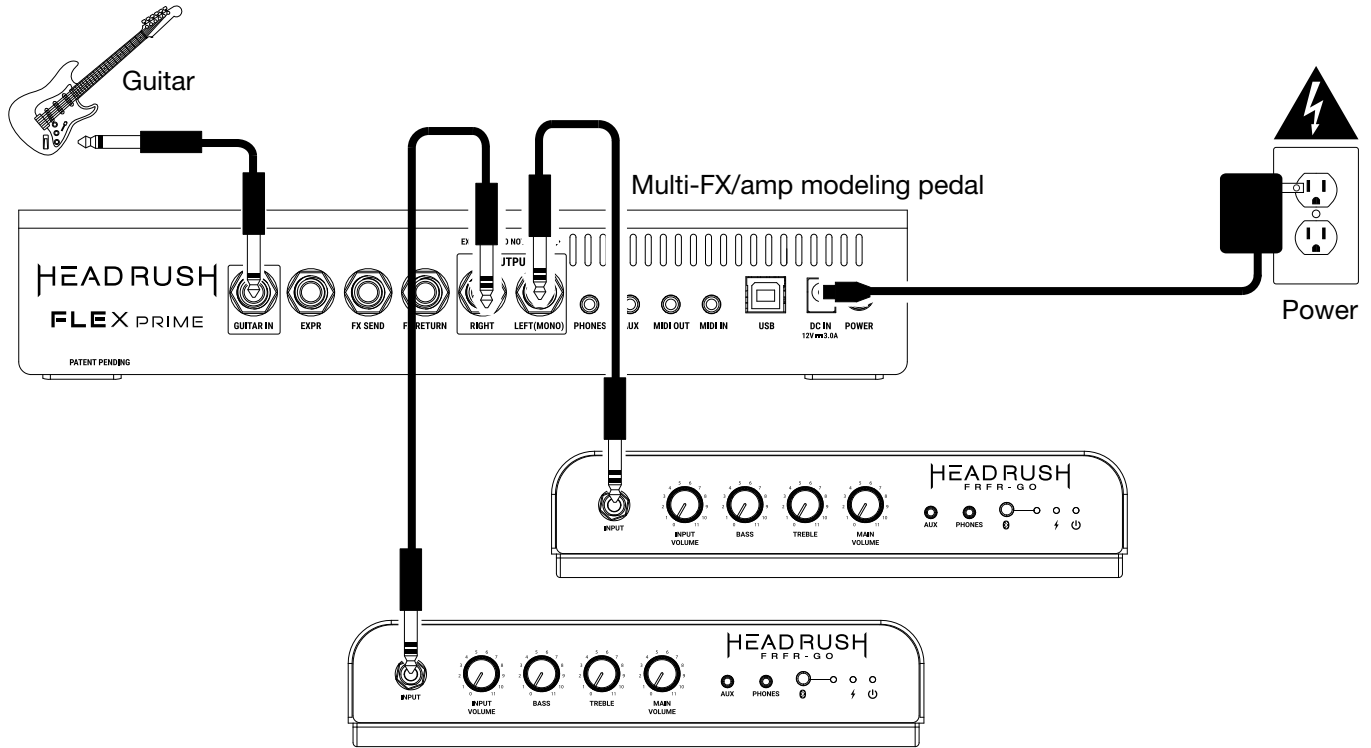

(4.4) Example C: One FRFR-GO (Stereo) AUX Input

Connect the Right and Left (Mono) outputs of your or guitar bass multi-FX/amp modeling pedal using a “Y” cable - (2) 1/4" TS to (1) 1/8" TRS, to the AUX input of your FRFR-GO.

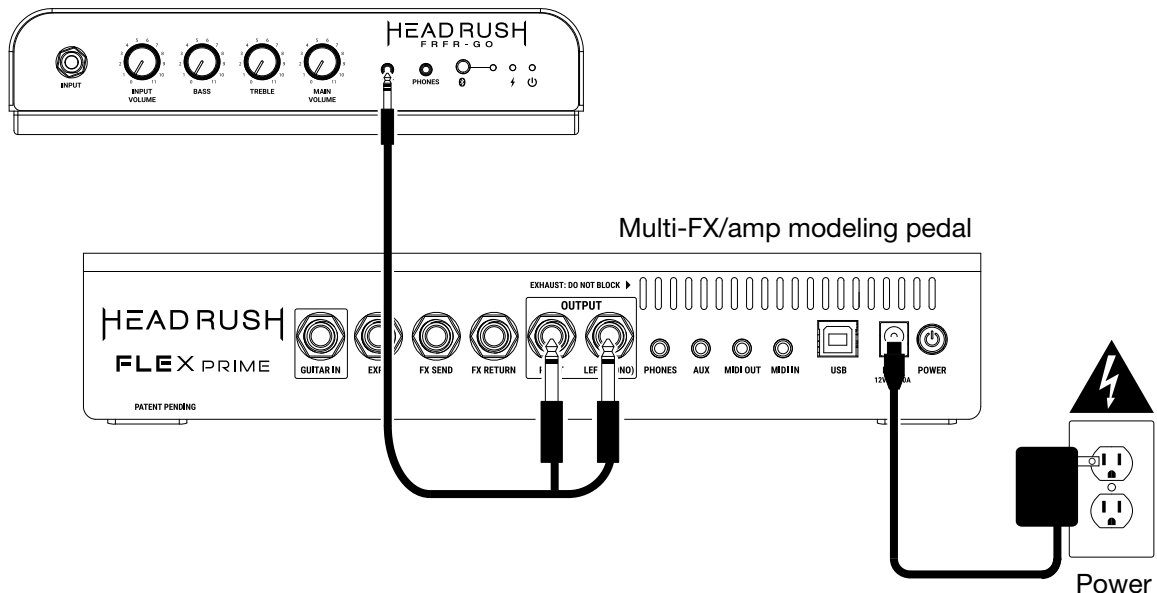

(5.0) Features

(5.1) Rear Panel



A. Power Input

Use the included power cable to connect this input to a power outlet. Make sure the **Power Switch** is set to **OFF** when connecting or disconnecting the cable.

B. Power Switch

Use this switch to power the loudspeaker **ON** or **OFF**. Make sure the volume knobs are set to the minimum (counterclockwise) positions before turning it on.

(5.2) Front Panel

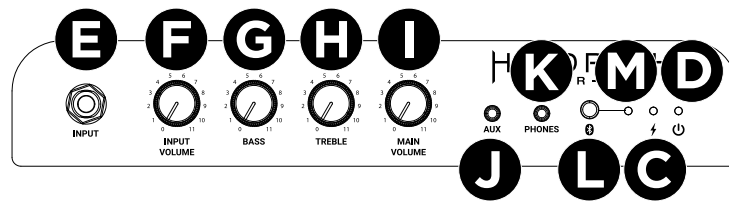

C. Charge LED

This LED will be lit green when fully charged and lit red when charging.

D. Power LED

This LED will be lit green when the speaker is powered on.

E. Input

Use a 1/4" (6.35 mm) instrument cable (not included) to connect your amp modeler to this line-level mono input. For stereo applications, connect to the Aux input.

F. Input Volume

Turn this knob to adjust the volume for the instrument input.

G. Bass

Turn this knob to adjust the low-end frequencies for the speaker output.

H. Treble

Turn this knob to adjust the high-end frequencies for the speaker output.

I. Main Volume

Turn this knob to adjust the overall volume of the speaker.

J. Aux

Connect an optional stereo audio source (e.g., tablet, drum machine, etc.) to this input using an 1/8" (3.5 mm) stereo cable.

K. Phones

Connect standard 1/8" (3.5 mm) stereo headphones to this output. This will mute the internal speaker. Control the level by using the MAIN VOLUME knob.

L. Bluetooth Pair

Use this button to enter Bluetooth Pairing Mode or disconnect a paired device.

M. Bluetooth LED

This blue LED will flash when the speaker is in pairing mode, be lit solid when a device is paired, and will be unlit when a Bluetooth device is not paired.

(6.0) Operation

(6.1) Pairing a Bluetooth Device

1. Power on the FRFR-GO. The Bluetooth LED will not be lit when the speaker is first powered on unless it was previously paired with a device before being powered off.
2. Press and hold the **Bluetooth** button for 1.5 seconds, and then release it. The **Bluetooth LED** will flash when in pairing mode.
3. Navigate to your Bluetooth device's setup screen, find **FRFR-GO**, and connect. The **Bluetooth LED** will be lit solid when a device is paired.

Note: If your Bluetooth device prompts that a pairing code is required, use "0000".

4. Adjust the volume using the **Main Volume** knob.

To unpair a device, press and hold the **Bluetooth** button for 1.5 seconds.



Flip the switch to ON

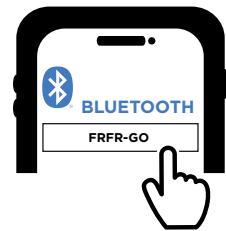
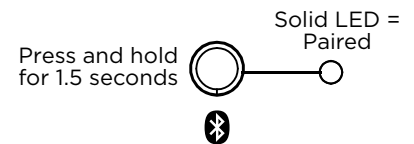

(7.0) Troubleshooting

If the sound is distorted: Try lowering the volume control of your amp modeler. You will want your amp modeler's live-level output to be as close to unity gain (0 dB) without going over. For HeadRush modelers, set the main volume knob around "7", depending on your rig's setup. If you are unsure of where the unity gain position of your amp modeler is, check your amp modeler's User Guide.

If you are experiencing feedback: Try placing the FRFR-GO in a different location, or pointing/moving your guitar away from the speaker. If your amp modeler has a "noise gate" feature, you can also try enabling this to help reduce the unwanted noise.

I hear a hum when cables are connected:

- Disconnect cables from the input jack to see if it's a faulty cable.
- Use balanced cabling connections whenever possible.
- Make sure the signal cable is not placed near power cables.
- Connect all audio equipment power cables to outlets which share a common ground.

If there is too much bass: Try adjusting the EQ control to lower the bass level. Also, try moving the speaker to another location. Depending on their construction and materials, some desktop surfaces or shelving may increase the level of bass frequencies.

If you cannot connect your audio device to FRFR-GO via Bluetooth:

- Have your audio device (e.g., smartphone or tablet) and FRFR-GO as close together as possible while trying to connect. Make sure both the audio device and FRFR-GO are unobstructed by walls, furniture, etc.
- Reset the Bluetooth connection on FRFR-GO to disconnect FRFR-GO from any other audio device and restart the search process. If this does not work right away, power off FRFR-GO and then power it back on.
- Reset the Bluetooth connection on your audio device by turning Bluetooth off and back on. You can find this under the Bluetooth menu in the Settings for your phone or other audio device.

(8.0) Appendix

(8.1) Technical Specifications

Output Power (peak)	30W (2x15W) when using main power, 24W (2x12W) when using battery power
Drivers	(2) 3" full-range drivers at 4 Ω
Maximum SPL	109.4 dB (peak)
Frequency Response	75 Hz – 20 kHz (-10 dB)
Connectors	Input: 1/4" (6.35 mm) line-level amp modeler mono input Aux Input: 1/8" (3.5 mm) line-level stereo input Headphones Output: 1/8" (3.5 mm) stereo output
Amp Modeler Max Input Level	0 dB
Headphone Impedance	22 Ω (typical 282mW per channel, <1% THD using 32 Ω impedance headphones)
Bluetooth	Version: 5.0 Profile: A2DP, AVRCP Codec: SBC Range: up to 100 feet (30.5m)
Power	Connection: C7 power cable Input Voltage: 100-120V, 50/60Hz; 220-240V, 50-60Hz Consumption: 45 W
Battery	Type: Rechargeable lithium-ion Recharge Time: Up to 3 hours Battery Life: Up to 13 hours (may vary depending on use conditions)
Protection	Electronic soft clip, thermal, and transducer overdrive protection
Enclosure	Vinyl-wrapped MDF with cloth grille and rear bass port
Operating Temperature	0°C to 45°C (32°F to 113°F)
Dimensions (width x depth x height)	12.6" x 5.91" x 7.24" (320 x 150 x 184 mm)
Weight	7.39 lbs. / 3.35 kg

Specifications are subject to change without notice.

(8.2) Trademarks & Licenses

HeadRush is a trademark of inMusic Brands, Inc., registered in the U.S. and other countries.

The *Bluetooth* word mark and logos are owned by the Bluetooth SIG, Inc., and any use of such marks by HeadRush is under license.

All other product names, company names, trademarks, or trade names are those of their respective owners.

headrushfx.com