

marantz
PROFESSIONAL

Model PMD661MKII User Guide

Handheld Solid State Recorder



CAUTION
RISK OF ELECTRIC SHOCK
DO NOT OPEN



CAUTION:

TO REDUCE THE RISK OF ELECTRIC SHOCK, DO NOT REMOVE COVER (OR BACK).

NO USER-SERVICEABLE PARTS INSIDE. REFER SERVICING TO QUALIFIED SERVICE PERSONNEL.



The lightning flash with arrowhead symbol, within an equilateral triangle, is intended to alert the user to the presence of uninsulated "dangerous voltage" within the product's enclosure that may be of sufficient magnitude to constitute a risk of electric shock to persons.



The exclamation point within an equilateral triangle is intended to alert the user to the presence of important operating and maintenance (servicing) instructions in the literature accompanying the appliance.

IMPORTANT TO SAFETY

WARNING:

To reduce the risk of fire and electric shock, this apparatus should not be exposed to rain or moisture and objects filled with liquids, such as vases, should not be placed on this apparatus.

CAUTION:

USE OF CONTROLS OR ADJUSTMENTS OR PERFORMANCE OF PROCEDURES OTHER THAN THOSE SPECIFIED HEREIN MAY RESULT IN HAZARDOUS RADIATION EXPOSURE.

THIS PRODUCT SHOULD NOT BE ADJUSTED OR REPAIRED BY ANYONE EXCEPT PROPERLY QUALIFIED SERVICE PERSONNEL.

FCC INFORMATION
(For US customers)

1. COMPLIANCE INFORMATION

Product Name: Handheld Solid State Recorder
Model Number: PMD661MKII

This product complies with Part 15 of the FCC Rules. Operation is subject to the following two conditions: (1) this product may not cause harmful interference, and (2) this product must accept any interference received, including interference that may cause undesired operation.

Marantz Professional div. D&M Professional
 1100 Maplewood Drive Itasca, IL 60143
 Tel. 630-741-0330

2. IMPORTANT NOTICE: DO NOT MODIFY THIS PRODUCT

This product, when installed as indicated in the instructions contained in this manual, meets FCC requirements. Modification not expressly approved by Marantz may void your authority, granted by the FCC, to use the product.

3. IMPORTANT

When connecting this product to network hub or router, use only a shielded STP or ScTP LAN cable which is available at retailer. Follow all installation instructions. Failure to follow instructions could void your authority, granted by the FCC, to use the product.

4. NOTE

This product has been tested and found to comply with the limits for a Class B digital device, pursuant to Part 15 of the FCC Rules. These limits are designed to provide reasonable protection against harmful interference in a residential installation.

This product generates, uses and can radiate radio frequency energy and, if not installed and used in accordance with the instructions, may cause harmful interference to radio communications. However, there is no guarantee that interference will not occur in a particular installation. If this product does cause harmful interference to radio or television reception, which can be determined by turning the product OFF and ON, the user is encouraged to try to correct the interference by one or more of the following measures:

- Reorient or relocate the receiving antenna.
- Increase the separation between the equipment and receiver.
- Connect the product into an outlet on a circuit different from that to which the receiver is connected.
- Consult the local retailer authorized to distribute this type of product or an experienced radio/TV technician for help.

For Canadian customers:

This Class B apparatus complies with Canadian ICES-003.

Cet appareil numérique de la classe B est conforme à la norme NMB-003 du Canada.

IMPORTANT SAFETY INSTRUCTIONS

READ BEFORE OPERATING EQUIPMENT

This product was designed and manufactured to meet strict quality and safety standards. There are, however, some installation and operation precautions which you should be particularly aware of.

1. Read these instructions.
2. Keep these instructions.
3. Heed all warnings.
4. Follow all instructions.
5. Do not use this apparatus near water.
6. Clean only with dry cloth.
7. Do not block any ventilation openings. Install in accordance with the manufacturer's instructions.
8. Do not install near any heat sources such as radiators, heat registers, stoves, or other apparatus (including amplifiers) that produce heat.
9. Do not defeat the safety purpose of the polarized or grounding-type plug. A polarized plug has two blades with one wider than the other. A grounding type plug has two blades and a third grounding prong. The wide blade or the third prong are provided for your safety. If the provided plug does not fit into your outlet, consult an electrician for replacement of the obsolete outlet.
10. Protect the power cord from being walked on or pinched particularly at plugs, convenience receptacles, and the point where they exit from the apparatus.
11. Only use attachments/accessories specified by the manufacturer.
12. Use only with the cart, stand, tripod, bracket, or table specified by the manufacturer, or sold with the apparatus. When a cart is used, use caution when moving the cart/apparatus combination to avoid injury from tip-over.
13. Unplug this apparatus during lightning storms or when unused for long periods of time.
14. Refer all servicing to qualified service personnel. Servicing is required when the apparatus has been damaged in any way, such as power-supply cord or plug is damaged, liquid has been spilled or objects have fallen into the apparatus, the apparatus has been exposed to rain or moisture, does not operate normally, or has been dropped.



CAUTION

1. Handle the power supply cord carefully

Do not damage or deform the power supply cord. If it is damaged or deformed, it may cause electric shock or malfunction when used. When removing from wall outlet, be sure to remove by holding the plug attachment and not by pulling the cord.

2. Do not open the rear cover

In order to prevent electric shock, do not open the top cover.
If problems occur, contact your Marantz DEALER.

3. Do not place anything inside

Do not place metal objects or spill liquid inside the system.
Electric shock or malfunction may result.

Please, record and retain the Model name and serial number of your set shown on the rating label.

Model No. PMD661MKII

Serial No. _____

NOTE ON USE

English

WARNINGS

- Handle the power cord carefully.
- Hold the plug when unplugging the cord.
- Keep the unit free from moisture, water, and dust.
- Unplug the power cord when not using the unit for long periods of time.
- Do not obstruct the ventilation holes.
- Do not let foreign objects into the unit.
- Do not let insecticides, benzene, and thinner come in contact with the unit.
- Never disassemble or modify the unit in any way.
- Ventilation should not be impeded by covering the ventilation openings with items, such as newspapers, tablecloths or curtains.
- Naked flame sources such as lighted candles should not be placed on the unit.
- Do not expose the unit to dripping or splashing fluids.
- Do not place objects filled with liquids, such as vases, on the unit.
- Do not handle the mains cord with wet hands.
- When the switch is in the OFF position, the equipment is not completely switched off from MAINS.
- The equipment shall be installed near the power supply so that the power supply is easily accessible.

OBSERVATIONS RELATIVES A L'UTILISATION

Français

AVERTISSEMENTS

- Manipuler le cordon d'alimentation avec précaution.
- Tenir la prise lors du débranchement du cordon.
- Protéger l'appareil contre l'humidité, l'eau et la poussière.
- Débrancher le cordon d'alimentation lorsque l'appareil n'est pas utilisé pendant de longues périodes.
- Ne pas obstruer les trous d'aération.
- Ne pas laisser des objets étrangers dans l'appareil.
- Ne pas mettre en contact des insecticides, du benzène et un diluant avec l'appareil.
- Ne jamais démonter ou modifier l'appareil d'une manière ou d'une autre.
- Ne pas recouvrir les orifices de ventilation avec des objets tels que des journaux, nappes ou rideaux. Cela entraverait la ventilation.
- Ne jamais placer de flamme nue sur l'appareil, notamment des bougies allumées.
- L'appareil ne doit pas être exposé à l'eau ou à l'humidité.
- Ne pas poser d'objet contenant du liquide, par exemple un vase, sur l'appareil.
- Ne pas manipuler le cordon d'alimentation avec les mains mouillées.
- Lorsque l'interrupteur est sur la position OFF, l'appareil n'est pas complètement déconnecté du SECTEUR (MAINS).
- L'appareil sera installé près de la source d'alimentation, de sorte que cette dernière soit facilement accessible.

NOTAS SOBRE EL USO

Español

ADVERTENCIAS

- Maneje el cordón de energía con cuidado.
- Sostenga el enchufe cuando desconecte el cordón de energía.
- Mantenga el equipo libre de humedad, agua y polvo.
- Desconecte el cordón de energía cuando no utilice el equipo por mucho tiempo.
- No obstruya los orificios de ventilación.
- No deje objetos extraños dentro del equipo.
- No permita el contacto de insecticidas, gasolina y diluyentes con el equipo.
- Nunca desarme o modifique el equipo de ninguna manera.
- La ventilación no debe quedar obstruida por haberse cubierto las aperturas con objetos como periódicos, manteles o cortinas.
- No deberán colocarse sobre el aparato fuentes inflamables sin protección, como velas encendidas.
- No exponer el aparato al goteo o salpicaduras cuando se utilice.
- No colocar sobre el aparato objetos llenos de líquido, como jarras.
- No maneje el cable de alimentación con las manos mojadas.
- Cuando el interruptor está en la posición OFF, el equipo no está completamente desconectado de la alimentación MAINS.
- El equipo se instalará cerca de la fuente de alimentación de manera que resulte fácil acceder a ella.

HINWEISE ZUM GEBRAUCH

Deutsch

WARNHINWEISE

- Gehen Sie vorsichtig mit dem Netzkabel um.
- Halten Sie das Kabel am Stecker, wenn Sie den Stecker herausziehen.
- Halten Sie das Gerät von Feuchtigkeit, Wasser und Staub fern.
- Decken Sie den Lüftungsbereich nicht ab.
- Wenn das Gerät längere Zeit nicht verwendet werden soll, trennen Sie das Netzkabel vom Netzstecker.
- Lassen Sie keine fremden Gegenstände in das Gerät kommen.
- Lassen Sie das Gerät nicht mit Insektiziden, Benzin oder Verdünnungsmitteln in Berührung kommen.
- Versuchen Sie niemals das Gerät auseinander zu nehmen oder zu verändern.
- Die Belüftung sollte auf keinen Fall durch das Abdecken der Belüftungsöffnungen durch Gegenstände wie beispielsweise Zeitungen, Tischtücher, Vorhänge o. Ä. behindert werden.
- Auf dem Gerät sollten keinerlei direkte Feuerquellen wie beispielsweise angezündete Kerzen aufgestellt werden.
- Das Gerät sollte keiner tropfenden oder spritzenden Flüssigkeit ausgesetzt werden.
- Auf dem Gerät sollten keine mit Flüssigkeit gefüllten Behälter wie beispielsweise Vasen aufgestellt werden.
- Das Netzkabel nicht mit feuchten oder nassen Händen anfassen.
- Wenn der Schalter ausgeschaltet ist (OFF-Position), ist das Gerät nicht vollständig vom Stromnetz (MAINS) abgetrennt.
- Das Gerät sollte in der Nähe einer Netzsteckdose aufgestellt werden, damit es leicht an das Stromnetz angeschlossen werden kann.

NOTE SULL'USO

Italiano

AVVERTENZE

- Maneggiate il cavo di alimentazione con attenzione.
- Tenete ferma la spina quando scollegate il cavo dalla presa.
- Tenete l'unità lontana dall'umidità, dall'acqua e dalla polvere.
- Scollegate il cavo di alimentazione quando prevedete di non utilizzare l'unità per un lungo periodo di tempo.
- Non coprite i fori di ventilazione.
- Non inserite corpi estranei all'interno dell'unità.
- Assicuratevi che l'unità non entri in contatto con insetticidi, benzolo o solventi.
- Non smontate né modificate l'unità in alcun modo.
- Le aperture di ventilazione non devono essere ostruite coprendole con oggetti, quali giornali, tovaglie, tende e così via.
- Non posizionate sull'unità fiamme libere, come ad esempio candele accese.
- L'apparecchiatura non deve essere esposta a gocciolii o spruzzi.
- Non posizionate sull'unità alcun oggetto contenente liquidi, come ad esempio i vasi.
- Non toccare il cavo di alimentazione con le mani bagnate.
- Quando l'interruttore è nella posizione OFF, l'apparecchiatura non è completamente scollegata da MAINS.
- L'apparecchio va installato in prossimità della fonte di alimentazione, in modo che quest'ultima sia facilmente accessibile.

NOTA SOBRE UTILIZAÇÃO

Português

AVISOS

- Manuseie o cabo de alimentação com cuidado. Puxe pela ficha quando desligar o cabo de alimentação.
- Mantenha a unidade afastada da humidade, da água e do pó.
- Desligue o cabo de alimentação quando não estiver a utilizar a unidade por longos períodos de tempo.
- Não obstrua os orifícios de ventilação.
- Não deixe objectos estranhos dentro da unidade.
- Não permita que insecticidas, gasolina e diluente entrem em contacto com a unidade.
- Nunca desmonte ou modifique de alguma forma a unidade.
- A ventilação não deve ser obstruída, tapando as aberturas de ventilação com objectos, como jornais, toalhas ou cortinas.
- Não devem ser colocadas junto à unidade fontes de chama aberta, como velas acesas.
- Não exponha a unidade a gotejamento ou salpicos de líquidos.
- Não coloque objectos com líquidos, como jaras, em cima da unidade.
- Não manuseie o cabo de alimentação com as mãos molhadas.
- Quando o interruptor se encontra na posição OFF, o equipamento não está completamente desligado da REDE ELÉCTRICA.
- O equipamento deve ser instalado junto da fonte de alimentação, para que a fonte de alimentação esteja facilmente acessível.

OBSERVERA

Svenska

VARNINGAR

- Hantera nätkabeln varsamt.
- Håll i kabeln när den kopplas från el-uttaget.
- Utsätt inte apparaten för fukt, vatten och damm.
- Koppla loss nätkabeln om apparaten inte kommer att användas i lång tid.
- Täpp inte till ventilationsöppningarna.
- Se till att främmande föremål inte tränger in i apparaten.
- Se till att inte insektsmedel på spraybruk, bensen och thinner kommer i kontakt med apparatens hölje.
- Ta inte isär apparaten och försök inte bygga om den.
- Ventilationen bör inte förhindras genom att täcka för ventilationsöppningarna med föremål såsom tidningar, bordsdukar eller gardiner.
- Placera inte öppen eld, t.ex. tända ljus, på apparaten.
- Apparaten får inte utsättas för vätska.
- Placera inte föremål fyllda med vätska, t.ex. vasor, på apparaten.
- Hantera inte nåtsladden med våta händer.
- Även om strömbrytaren står i det avstängda läget OFF, så är utrustningen inte helt bortkopplad från det elektriska nätet (MAINS).
- Utrustningen ska vara installerad nära strömuttaget så att strömförsörjningen är lätt att tillgå.

ALVORENS TE GEBRUIKEN

Nederlands

WAARSCHUWINGEN

- Hanteer het netsnoer voorzichtig.
- Houd het snoer bij de stekker vast wanneer deze moet worden aan- of losgekoppeld.
- Laat geen vochtigheid, water of stof in het apparaat binnendringen.
- Neem altijd het netsnoer uit het stopcontact wanneer het apparaat gedurende een lange periode niet wordt gebruikt.
- De ventilatieopeningen mogen niet worden geblokkeerd.
- Laat geen vreemde voorwerpen in dit apparaat vallen.
- Voorkom dat insecticiden, benzene of verfvandner met dit toestel in contact komen.
- Dit toestel mag niet gedemonteerd of aangepast worden.
- De ventilatie mag niet worden belemmerd door de ventilatieopeningen af te dekken met bijvoorbeeld kranten, een tafelkleed of gordijnen.
- Plaats geen open vlammen, bijvoorbeeld een brandende kaars, op het apparaat.
- Stel het apparaat niet bloot aan druppels of spatten.
- Plaats geen voorwerpen gevuld met water, bijvoorbeeld een vaas, op het apparaat.
- Raak het netsnoer niet met natte handen aan.
- Als de schakelaar op OFF staat, is het apparaat niet volledig losgekoppeld van de netspanning (MAINS).
- De apparatuur wordt in de buurt van het stopcontact geïnstalleerd, zodat dit altijd gemakkelijk toegankelijk is.

DECLARATION OF CONFORMITY

English

We declare under our sole responsibility that this product, to which this declaration relates, is in conformity with the following standards:
EN60065, EN55013, EN55020, EN61000-3-2 and EN61000-3-3.
Following the provisions of Low Voltage Directive 2006/95/EC and EMC Directive 2004/108/EC, the EC regulation 1275/2008 and its frame work Directive 2009/125/EC for Energy-related Products (ErP).

DECLARATION DE CONFORMITE

Français

Nous déclarons sous notre seule responsabilité que l'appareil, auquel se réfère cette déclaration, est conforme aux standards suivants:
EN60065, EN55013, EN55020, EN61000-3-2 et EN61000-3-3.
Selon la directive 2006/95/EC concernant la basse tension et la directive CEM 2004/108/EC, la réglementation européenne 1275/2008 et la directive 2009/125/EC établissant un cadre de travail applicable aux produits liés à l'énergie (ErP).

DECLARACIÓN DE CONFORMIDAD

Español

Declaramos bajo nuestra exclusiva responsabilidad que este producto al que hace referencia esta declaración, está conforme con los siguientes estándares:
EN60065, EN55013, EN55020, EN61000-3-2 y EN61000-3-3.
De acuerdo con la directiva sobre baja tensión 2006/95/CE y la directiva sobre CEM 2004/108/CE, la normativa CE 1275/2008 y su directiva marco 2009/125/EC para productos relacionados con la energía (ErP).

ÜBEREINSTIMMUNGSERKLÄRUNG

Deutsch

Wir erklären unter unserer Verantwortung, daß dieses Produkt, auf das sich diese Erklärung bezieht, den folgenden Standards entspricht:
EN60065, EN55013, EN55020, EN61000-3-2 und EN61000-3-3.
Gemäß den Bestimmungen der Niederspannungsrichtlinie 2006/95/EG und EMV Richtlinie 2004/108/EG, der Verordnung (EG) Nr. 1275/2008 der Kommission und deren Rahmenrichtlinie 2009/125/EG zu energieverbrauchsrelevanten Produkten (ErP).

DICHIARAZIONE DI CONFORMITÀ

Italiano

Dichiariamo con piena responsabilità che questo prodotto, al quale la nostra dichiarazione si riferisce, è conforme alle seguenti normative:
EN60065, EN55013, EN55020, EN61000-3-2 e EN61000-3-3.
Facendo seguito alle disposizioni della direttiva sul basso voltaggio 2006/95/EC alla direttiva EMC 2004/108/EC, alla norma EC 1275/2008 e alla relativa legge quadro 2009/125/EC in materia di prodotti alimentati ad energia (ErP).
QUESTO PRODOTTO E' CONFORME
AL D.M. 28/08/95 N. 548

DECLARAÇÃO DE CONFORMIDADE

Português

Declaramos sob nossa exclusiva responsabilidade que este produto, ao qual se refere esta declaração, se encontra em conformidade com as seguintes normas:
EN60065, EN55013, EN55020, EN61000-3-2 e EN61000-3-3.
De acordo com as provisões da Directiva de Baixa Tensão 2006/95/CE e a Directiva CEM 2004/108/CE, o Regulamento (CE) 1275/2008 e a respectiva Directiva-Quadro 2009/125/CE para produtos relacionados com o consumo de energia (ErP).

ÖVERENSSTÄMMELSESINTYG

Svenska

Härmed intygas helt på eget ansvar att denna produkt, vilken detta intyg avser, uppfyller följande standarder:
EN60065, EN55013, EN55020, EN61000-3-2 och EN61000-3-3.
Uppfyller reglerna i lågspänningsdirektivet 2006/95/EC och EMC-direktivet 2004/108/EC, EU-förordningen 1275/2008 och ramverksdirektivet 2009/125/EC för energirelaterade produkter (ErP).

EENVORMIGHEIDSVERKLARING

Nederlands

Wij verklaren uitsluitend op onze verantwoordelijkheid dat dit product, waarop deze verklaring betrekking heeft, in overeenstemming is met de volgende normen:
EN60065, EN55013, EN55020, EN61000-3-2 en EN61000-3-3.
Volgens de voorzieningen van lage spanningsrichtlijn 2006/95/EC en EMC-richtlijn 2004/108/EC, de EU-richtlijn 1275/2008 en de kaderrichtlijn 2009/125/EC voor energieverbruikende producten (ErP).

D&M Professional Europe
A division of D&M Europe B.V.
Beemdstraat 11
5653 MA Eindhoven
The Netherlands

CAUTION:**English**

To completely disconnect this product from the mains, disconnect the plug from the wall socket outlet.

The mains plug is used to completely interrupt the power supply to the unit and must be within easy access by the user.

PRECAUTION:**Français**

Pour déconnecter complètement ce produit du courant secteur, débranchez la prise de la prise murale.

La prise secteur est utilisée pour couper complètement l'alimentation de l'appareil et l'utilisateur doit pouvoir y accéder facilement.

PRECAUCIÓN:**Español**

Para desconectar completamente este producto de la alimentación eléctrica, desconecte el enchufe del enchufe de la pared.

El enchufe de la alimentación se utiliza para interrumpir por completo el suministro de alimentación a la unidad y debe de encontrarse en un lugar al que el usuario tenga fácil acceso.

VORSICHT:**Deutsch**

Um dieses Gerät vollständig von der Stromversorgung abzutrennen, trennen Sie bitte den Netzstecker von der Wandsteckdose ab.

Die Hauptstecker werden verwendet, um die Stromversorgung zum Gerät völlig zu unterbrechen; er muss für den Benutzer gut und einfach zu erreichen sein.

ATTENZIONE:**Italiano**

Per scollegare definitivamente questo prodotto dalla rete di alimentazione elettrica, togliere la spina dalla relativa presa.

La spina di rete viene utilizzata per interrompere completamente l'alimentazione all'unità e deve essere facilmente accessibile all'utente.

ATENÇÃO:**Português**

Para desligar completamente este produto da corrente, desligue a ficha da tomada eléctrica.

A ficha eléctrica é utilizada para interromper completamente a alimentação da unidade e deve estar num local onde o utilizador lhe possa aceder facilmente. Não exponha as pilhas a fontes de calor excessivo, como luz solar, fogo ou semelhantes.

FÖRSIKTIHETSMÅTT:**Svenska**

Koppla loss stickproppen från eluttaget för att helt skilja produkten från nätet.

Stickproppen används för att helt bryta strömförsörjningen till apparaten, och den måste vara lättillgänglig för användaren.

VOORZICHTIGHEID:**Nederlands**

Om de voeding van dit product volledig te onderbreken moet de stekker uit het stopcontact worden getrokken.

De netstekker wordt gebruikt om de stroomtoevoer naar het toestel volledig te onderbreken en moet voor de gebruiker gemakkelijk bereikbaar zijn.

A NOTE ABOUT RECYCLING:

This product's packaging materials are recyclable and can be reused. Please dispose of any materials in accordance with the local recycling regulations.

When discarding the unit, comply with local rules or regulations.

Batteries should never be thrown away or incinerated but disposed of in accordance with the local regulations concerning battery disposal.

This product and the supplied accessories, excluding the batteries, constitute the applicable product according to the WEEE directive.

English



UNE REMARQUE CONCERNANT LE RECYCLAGE:

Les matériaux d'emballage de ce produit sont recyclables et peuvent être réutilisés. Veuillez disposer des matériaux conformément aux lois sur le recyclage en vigueur.

Lorsque vous mettez cet appareil au rebut, respectez les lois ou réglementations en vigueur.

Les piles ne doivent jamais être jetées ou incinérées, mais mises au rebut conformément aux lois en vigueur sur la mise au rebut des piles.

Ce produit et les accessoires inclus, à l'exception des piles, sont des produits conformes à la directive DEEE.

Français



ACERCA DEL RECICLAJE:

Los materiales de embalaje de este producto son reciclables y se pueden volver a utilizar. Disponga de estos materiales siguiendo los reglamentos de reciclaje de su localidad.

Cuando se deshaga de la unidad, cumpla con las reglas o reglamentos locales.

Las pilas nunca deberán tirarse ni incinerarse. Deberá disponer de ellas siguiendo los reglamentos de su localidad relacionados con los desperdicios químicos.

Este producto junto con los accesorios empaquetados es el producto aplicable a la directiva RAEE excepto pilas.

Español



Pb

HINWEIS ZUM RECYCLING:

Das Verpackungsmaterial dieses Produktes ist zum Recyceln geeignet und kann wieder verwendet werden. Bitte entsorgen Sie alle Materialien entsprechend der örtlichen Recycling-Vorschriften.

Beachten Sie bei der Entsorgung des Gerätes die örtlichen Vorschriften und Bestimmungen.

Die Batterien dürfen nicht in den Hausmüll geworfen oder verbrannt werden; bitte entsorgen Sie die Batterien gemäß der örtlichen Vorschriften.

Dieses Produkt und das im Lieferumfang enthaltene Zubehör (mit Ausnahme der Batterien!) entsprechen der WEEE-Direktive.

Deutsch

NOTA RELATIVA AL RICICLAGGIO:

I materiali di imballaggio di questo prodotto sono riutilizzabili e riciclabili. Smaltire i materiali conformemente alle normative locali sul riciclaggio.

Per lo smaltimento dell'unità, osservare le normative o le leggi locali in vigore.

Non gettare le batterie, né incenerirle, ma smaltirle conformemente alla normativa locale sui rifiuti chimici.

Questo prodotto e gli accessori inclusi nell'imballaggio sono applicabili alla direttiva RAEE, ad eccezione delle batterie.

Italiano



UMA NOTA SOBRE A RECICLAGEM:

Os materiais de embalagem deste produto são recicláveis e podem ser reutilizados. Elimine quaisquer materiais de acordo com as normas de reciclagem locais.

Quando eliminar a unidade, obedeça às regras ou normas locais.

As pilhas nunca devem ser deitadas fora ou incineradas, mas sim eliminadas de acordo com as normas locais relativas aos resíduos químicos.

Este produto e os respectivos acessórios embalados em conjunto constituem o produto aplicável de acordo com a directiva WEEE, excepto as pilhas.

Português



OBSERVERA ANGÅENDE ÅTERVINNING:

Produktens emballage är återvinningsbart och kan återanvändas. Kassera det enligt lokala återvinningsbestämmelser.

När du kasserar enheten ska du göra det i överensstämmelse med lokala regler och bestämmelser.

Batterier får absolut inte kastas i soporna eller brännas. Kassera dem enligt lokala bestämmelser för kemiskt avfall.

Denna apparat och de tillbehör som levereras med den uppfyller gällande WEEE-direktiv, med undantag av batterierna.

Svenska



EEN AANTEKENING MET BETREKKING TOT DE RECYCLING:

Het inpakmateriaal van dit product is recycleerbaar en kan opnieuw gebruikt worden. Er wordt verzocht om zich van elk afvalmateriaal te ontdoen volgens de plaatselijke voorschriften.

Volg voor het wegdoen van de speler de voorschriften voor de verwijdering van wit- en bruingoed op.

Batterijen mogen nooit worden weggegooid of verbrand, maar moeten volgens de plaatselijke voorschriften betreffende chemisch afval worden verwijderd.

Op dit product en de meegeleverde accessoires, m.u.v. de batterijen is de richtlijn voor afgedankte elektrische en elektronische apparaten (WEEE) van toepassing.

Nederlands

Pb

Table of Contents

Package Contents	2	Encrypted Recording	20	USB Mode	38
Introduction	3	Retake Recording	21	Computer compatible	38
Features	3	Basic Playback Operation	23	How to connect via the USB port	38
Quick Start Guide	4	Connection Diagram	23	Diagram of file structure	39
Names and Functions	6	Playback Procedure	23	Menu	40
Top	6	Access from File List	24	Menu Structure	40
Right Side	8	Search	25	Top Menu	41
Left Side	8	Skip Back	25	Protecting the Menu Settings	41
Front	9	Passcode Input	26	Preset Menu	42
Back	9	Advanced Features	27	Display Menu	51
Bottom	10	Microphone(s)	27	Utility Menu	53
Display	10	Pre Record	28	File List Menu	59
Preparation Before Use	11	Audio Filter	28	Folder List Menu	62
Installing the carry strap	11	Silent Skip	28	Troubleshooting	65
Installing batteries	11	Manual Track	28	Error Message	66
Removing batteries	12	Auto Track	29	Factory Default	67
Installing a memory card	13	Copy Segment	29	Specifications	68
Removing a memory card	13	File Divide	30	Limited Warranty	69
Clock Setting	14	Marking	31		
Language	15	Pitch Control.....	31		
Basic Recording Operation	16	Additional Features	32		
Connection Diagram	16	Key Lock.....	32		
Recording Procedure	16	Remote.....	33		
Audio Input for Recording.....	18	Extended Remote Jack	34		
Recording Time Chart	19	Display Control	35		
Recording Level Control.....	20				

Package Contents

- PMD661MKII

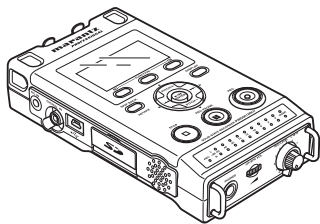

- Audio cable

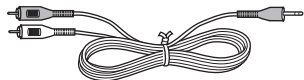

- USB cable

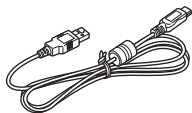

- AC adapter



- User guide

- CD-ROM

- Carry strap

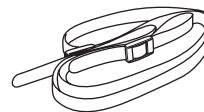

- SD card



Introduction

Thank you for selecting the Marantz Professional PMD661MKII Portable Solid State Recorder.

The PMD661MKII is an audio recorder that records in digital audio formats onto an SD (Secure Digital) card.

SD cards, also used in digital cameras, are widely available at consumer electronics retailers and computer resellers.

Features

- Stereo (2 channels) and mono (1 channel) audio recording and playback.
- Audio inputs may be from :
 - the built-in microphone(s),
 - condenser or dynamic microphone(s) connected to the XLR stereo jacks, or
 - line level audio sources connected to the XLR jacks or LINE 2 jack.
- Audio outputs may be from :
 - the built-in speakers,
 - headphones connected to the PHONES jack, or
 - analog audio devices such as an amplifier or other devices connected to the LINE OUT jack.
- Records onto various types of SD cards.
- Computer compatible
The PMD661MKII records directly onto SD cards. Recordings can be transferred to your desktop or laptop computer by removing the SD card from the PMD661MKII or by connecting the PMD661MKII to your computer via the USB port. Audio recorded in the popular MP3 compression format is directly available for intranet or internet file sharing.
- Easy one control recording
Simply push the **REC** button.
- Automatic recording
The PMD661MKII can be set to stop recording when there is silence (Silent Skip) and automatically start when sound resumes.
- Manual and automatic record level control (ALC).
- Two different recording formats :
 - Compressed recording using MP3 (MPEG1 Layer III) mono and stereo. MP3 compressed at 64/128/192/256/320 kbps.
 - Uncompressed recording using 16/24-bit linear Pulse Code Modulation (PCM).
- Copy Segment
Copy Segment works just like the copy and paste function of your standard word processing program. It allows you to “highlight” a section of a file by setting an in point and an out point, and then paste that section into a new file without destroying the original file(s).
- Timer Recording/Playback
Record start time and duration can be scheduled. Playback start time can be scheduled. (👉 P.54)
- Data secured
The recorded audio data until the recording stops is kept even if the power is interrupted suddenly during recording.
- Compatible with SDHC UHS-I card
- Retake function (👉 P.21)
- File encryption
- DMP Mark Editor software included

Quick Start Guide

Follow the instructions on this page to Quick Start your new PMD661MKII Solid State Recorder and begin recording. The PMD661MKII comes with factory preset defaults for MP3 recording using internal microphones.

1. Unpack the AC adapter and the PMD661MKII.

2. Setup the power supply.

- Use either the provided AC adapter or batteries.
- You can use 4 AA type batteries of Alkaline, or Nickel-Metal Hydride.

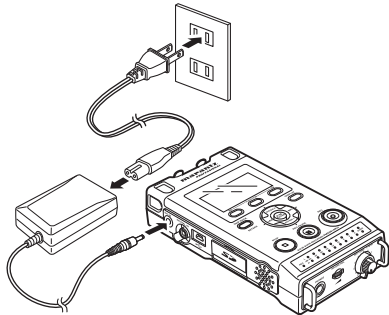

3. Slide and hold the **POWER** switch.



4. Press the **REC** button to start recording.

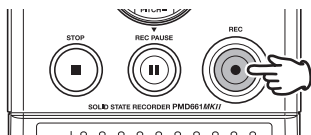

5. Press the **STOP** button to stop recording.

6. Press the **▶/||/ENTER** button to play the just recorded file via headphones or speaker.

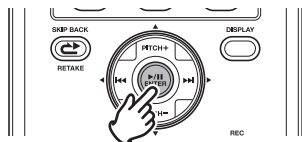

7. Press the **▶/||/ENTER** button again to pause playback.

8. Press the **STOP** button to stop playback.

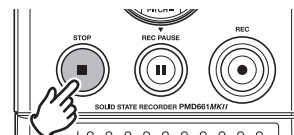

- For other recording condition, P.16.
- For the clock setting, P.14.

Names and Functions

Top

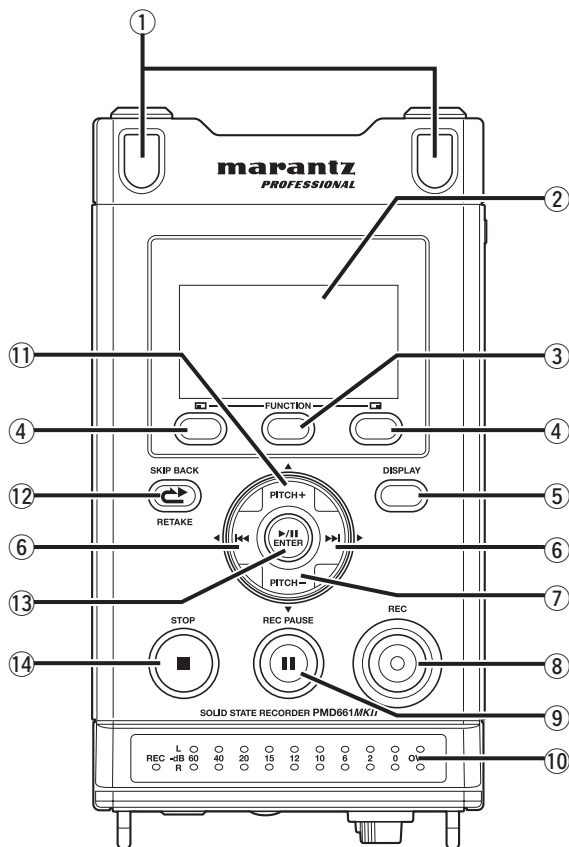

① Internal Microphones

Stereo condenser microphones.

② DISPLAY

The display shows the information of the PMD661MKII. (P.10)

③ FUNCTION button

Press the **FUNCTION** button to change the functions on **(F1)** and **(F2)** buttons with toggle operation. The functions are different depending on each operation mode.

④ (F1)/(F2) buttons

The functions of the **(F1)** and **(F2)** buttons depend on each operation mode and the **FUNCTION** button. Function (F1/F2) is indicated on the bottom corner of the display. The functions change automatically when the status changes. The 2nd or 3rd function in the same status can be selected by pressing the **FUNCTION** button.

Functions of (F1)/(F2) buttons

Operation mode	(F1) function	(F2) function
Stop	1. MENU	1. LIST (File List)
Record or Rec-Pause	1. TR (Manual Track)	1. MARK
	2. UNDO (Record Undo)	2. MARK
Stop after Record or Playback	1. MENU	1. LIST (File List)
	2. MK- (Mark Search -)	2. MK+ (Mark Search +)
Playback or Play-Pause	1. COPY (Copy Segment)	1. MARK
	2. DIV (Divide)	2. LIST (File List)
	3. MK- (Mark Search -)	3. MK+ (Mark Search +)

⑤ **DISPLAY button**

Press the **DISPLAY** button to change the display contents like the time information with toggle operation. The content is different depending on each operation mode.

⑥ **◀◀ / ▶▶ button**

- While in Stop, Playback, or Play-Pause mode, press this button to choose the file (Jump to previous/next file).
- In Play-Pause mode, press and hold this for high speed Reverse/Forward searching without audio. (Search -/Search +)
- In Playback mode, press and hold this to “rewind”/“fast forward” and do a 2X speed search. (Audible Search -/Search +)

⑦ **PITCH- button**

Press this button to make a speed down of playback. During menu mode, this button is used to change item.

⑧ **REC button**

Press this button to start recording from Stop or Rec-Pause mode.

⑨ **REC PAUSE button**

Press this button to enter the Rec-Pause mode from Stop or Record mode.

⑩ **Level LED (Green, Orange, Red)**

When a sound is input during Record, Rec-Pause or Playabck mode, it turns on.

⑪ **PITCH+ button**

Press this button to make a speed up of playback. During menu mode, this button is used to change item.

⑫ **SKIP BACK button**

Press the **SKIP BACK** button to skip back during playback or Play-Pause. Also, the Retake Record mode is set when this button is pressed during the Rec-Pause mode.

⑬ **▶/II/ENTER button**

Toggles Playback and Play Pause. During Menu mode, this is used to decide the choice.

⑭ **STOP button**

Press this button to stop the playback or recording and to release the Play-Pause or Rec-Pause mode. During menu mode, press this button to exit menu mode without to store memory.

Right Side

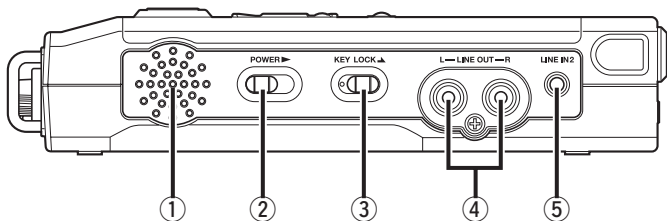

- 1 Speaker**
Internal speaker of R channel.
- 2 POWER slide switch**
Slide and hold for a little time to turn power On.
Slide to turn power Off. During Record and Rec-Pause mode, the **POWER** switch is invalid.
- 3 KEY LOCK slide switch**
Slide switch for the Key Lock On and Off control.
- 4 LINE OUT Jacks**
Insert an audio cable plug connected to an external audio device into these jacks to output audio signals to an external device (amp, etc.)
- 5 LINE IN 2 Jack**
Insert an audio cable plug connected to an external audio device into this jack to input the signals output from the external device into the recorder.

Left Side

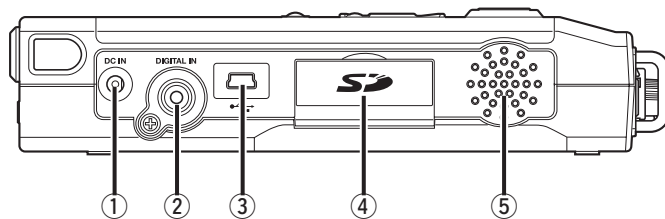

- 1 DC IN Jack**
Insert the provided AC adapter plug.
If the AC adapter plug is inserted while using the recorder on battery power, the recorder will automatically switch to adapter power. Also, if the AC adapter plug is removed, the recorder will automatically switch to battery power.
- 2 DIGITAL IN Jack**
Connect a digital audio cable with an RCA jack from an external device providing SPDIF digital output.
- 3 USB port (mini-B)**
The USB mode is started by connecting a USB cable while stopped.
- 4 Card compartment**
Pull the lid to access an SD card.
- 5 Speaker**
Internal speaker of L channel.

Front

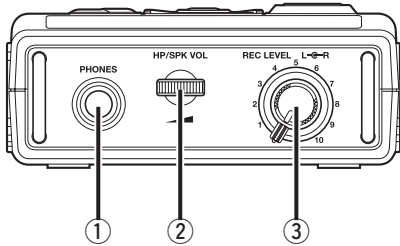

① PHONES Jack

For monitoring and private listening, you can connect your headphones to this jack.

② HP/SPK VOL Control

Use this to adjust the output level of the headphones or internal speakers.

Warning!

When using headphones, take care not to turn the volume too high. Listening at high volumes for extended periods of time may result in permanent hearing damage.

③ REC LEVEL Control

Turn to adjust the record level when the “Level Cont.” of preset menu is “Manual”.

The inside control (Right channel) and outside control (Left channel) turn together, unless you hold one while turning the other.

The optimum record level is when the level meter goes as close to 0dB as possible but does not go OVER.

Back

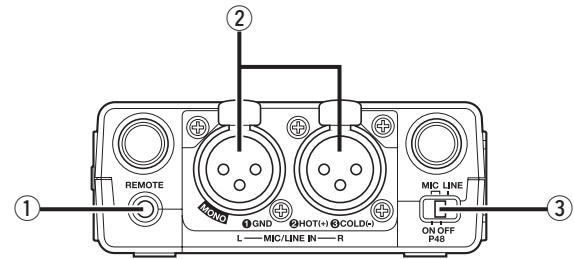

① REMOTE Control Jack

The Jack for the optional remote RC600PMD and the external remote controller.

② MIC/LINE IN Jacks

XLR stereo for MIC/LINE level.

③ PHANTOM/MIC slide switch

3 position slide switch. Phantom on, off or line. Phantom works to supply +48V to external microphones.

Bottom

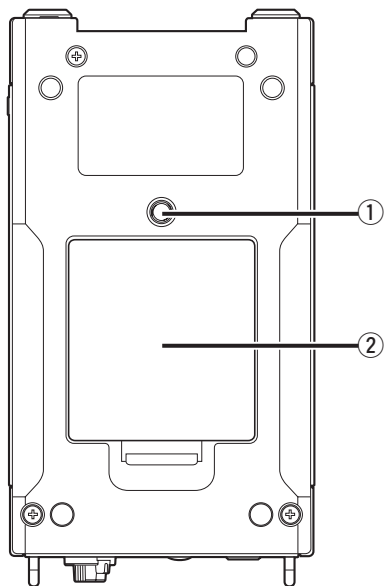

① Tripod Hole

Threaded screw hole for Tripod mount.

② Battery compartment

For 4 AA alkaline or rechargeable Ni-MH batteries.

Display



① Remaining space of the card

② Input source

③ F2 function

④ Status

⑤ Battery icon

⑥ Timer icon

This icon appears if the Timer Record/Playback is set. During the Timer Record/Playback, it blinks.

⑦ F1 function

⑧ Number of files

⑨ Total remain time

Preparation Before Use

Installing the carry strap

1. Put the carry strap through the shaft of the PMD661MKII.

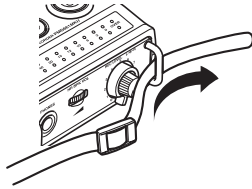

2. Put the carry strap through the stopper of the PMD661MKII.

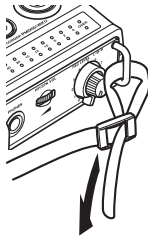

3. Secure the carry strap by putting it through the second stopper.

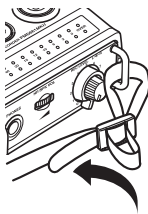

Installing batteries

1. Remove the battery compartment cover.

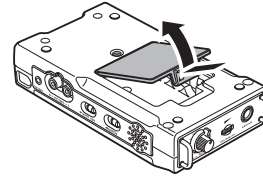

2. Insert the new batteries (AA type) with correct +/- polarity.

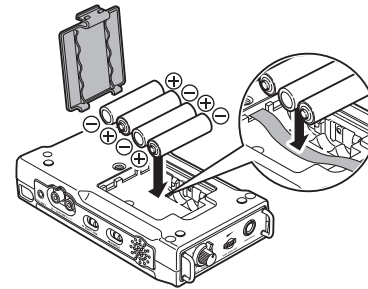

3. Close the battery compartment.

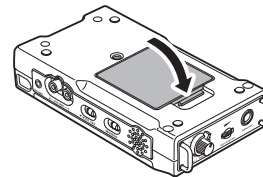

Removing batteries

Battery compartment is located in the bottom of the unit.

1. Remove the battery compartment door.
2. Remove four AA type batteries.
3. Close the battery compartment door.





Safety cautions on handling batteries

Always follow the points below when using batteries to avoid electrolyte leakage, overheating, fire, rupturing, ingestion, etc.

- Electrolyte leakage or corrosion may occur if batteries are kept inside the recorder for prolonged periods of time. If the recorder is not to be used for a prolonged period, remove the batteries to prevent electrolyte leakage.
- Make sure that the + and – markings on the batteries are aligned with the corresponding markings in the battery case and the battery holder.
- Do not insert old or exhausted batteries into the recorder.
- Do not mix the type of battery, and do not use both old and new batteries together.
- If the recorder does not operate correctly, replace the old batteries with new ones.
- If electrolyte has leaked, thoroughly wipe the inside of the battery holder, and then insert new batteries.
- Do not keep the battery in a place exposed to direct sunlight or in places with extremely high temperatures, such as near a heater.
- Used batteries should be disposed of in accordance with the local regulations regarding battery disposal.

Battery remaining indicator

The recorder operates using commercially available AA size alkaline or Ni-MH batteries. During operation, the battery remaining indicator is as follows.

Indicator	Meaning
	There is still ample battery power remaining.
	The amount of battery power remaining has decreased to approximately half.
	Only a small amount of battery power remaining.
	There is not enough battery power remaining to record or playback. Either replace the batteries with new ones, or recharge the rechargeable batteries. If you continue recording while this indicator is flashing, recording/playback will stop, and the recorder will shut down.
	The AC adapter is being used. The adapter power supply is valid.

Installing a memory card

The PMD661MKII records onto various types of SD cards.

1. Check that the power is turned off.
2. Pull the SD card lid.

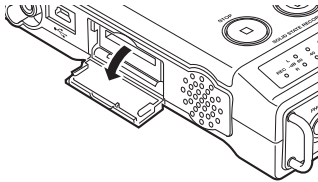

3. Fully insert the SD card.

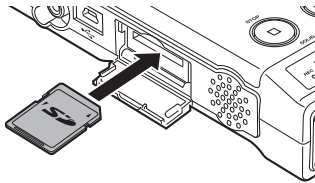

4. Close the SD card lid.

Removing a memory card

1. Check that the power is turned off.
2. Pull the SD card lid.
3. Push the card, then pull it to remove it.

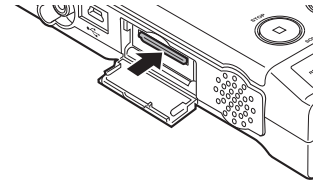

4. Close the SD card lid.

Note:

If the SD card lid opens while the power is on, “Door Open” message is displayed.

While recording is in progress, opening the SD card lid automatically stops recording and writes critical file information to properly close the file.

Clock Setting

The date and time are written on each audio track (file) when the track is started. When an audio track is viewed on a computer, this date and time appears as when the file was 'modified'.

1. From Stop, press the  (F1: MENU) button.

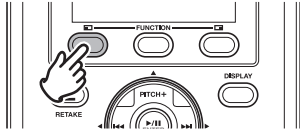



2. Press the **PITCH +** or **PITCH -** button to select "Time/Date".

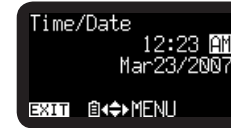

3. Press the /ENTER button to enter the Time/Date setting.



- Press the **STOP** button to cancel.
 - Press the **◀◀** or **▶▶** button to select the item.
 - When the hour is set, press the **◀◀** button to return to the Top Menu.
 - When the year is selected, the **▶▶** button is invalid.
 - Press the **PITCH +** or **PITCH -** button to select the value.
4. Press the  (F1: EXIT) button.
 - "Store?" appears on the display.
 - Select "Yes" and press the /ENTER button to write on the Real Time Clock.

Note:

If it happens to be the date which does not exist such as Feb. 31, it gets revised as back to Feb. 28.

Language

The Language menu item allows you to choose a display language (English, French, Spanish, German, Italian and Swedish).

1. From Stop, press the  (F1: MENU) button.

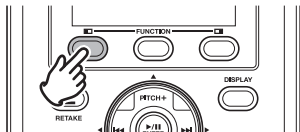

2. Press the **PITCH +** or **PITCH -** button to select “Language”.



3. Press the /ENTER button to enter the Language setting.



- Press the **STOP** button to cancel.
- Press the **PITCH +** or **PITCH -** button to select the item.
- The display language switches as shown below each time the **PITCH +** button is pressed.



- The display language switches as shown below each time the **PITCH -** button is pressed.



- Press the  button to return to the Top Menu.

4. Press the  (F1: EXIT) button.

- “Store?” appears on the display.
- Select “Yes” and press the /ENTER button to store the change.

Basic Recording Operation

Connection Diagram

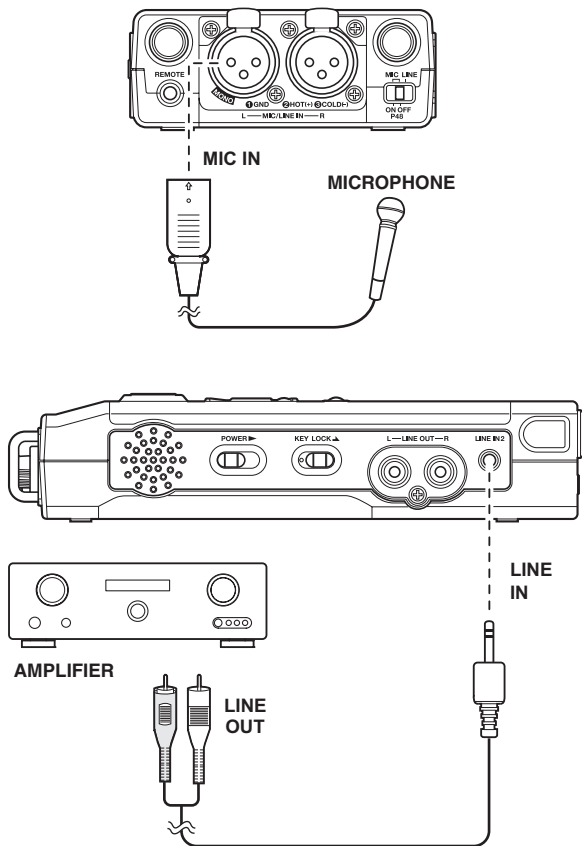

Recording Procedure

1. Slide and hold the **POWER** switch to turn on.



2. Press the **REC** button to begin recording.

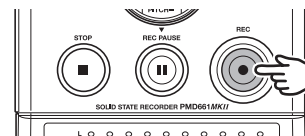

- The Rec indicator will be lit and steady while recording.
- The display will show the information display of recording.

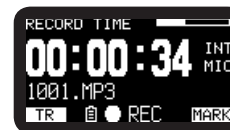

3. Press the **REC PAUSE** button to pause recording.
4. Press the **STOP** button to stop recording and end the file (close the audio file).

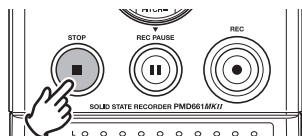

You can press the **▶/||/ENTER** button to play the just recorded file or press the **STOP** button again to enter the Stop mode. Then pressing the **▶/||/ENTER** button will play the beginning of the first audio file.

Audio Input for Recording

The audio input for recording can be set from the “Input” menu. (🔧 P.43)

Set the “Rec Channel” menu to “stereo” to create a stereo (2-channel) sound file. Or set it to “D.Mono” to create a stereo sound file. The left channel input is recorded in both left and right channels. Or set it to “mono” to create a monaural (1-channel) sound file. The monaural file will be almost half the size of the stereo file.

Set the PHANTOM/MIC switch to “ON” to select the microphone level sensitivity with phantom power 48 volts. Or set it to “OFF” to select the microphone level sensitivity without phantom power. Or set it to “LINE” to select the line level sensitivity.

#	INPUT	Rec Channel	PHANTOM/MIC switch	Description
1	INT MIC	Stereo	Invalid	Left/Right channel stereo recording.
2		D.Mono		Left/Left channel stereo recording. The Right channel is attenuated by 20dB. • The Left channel input is recorded in both Left and Right channels.
3		Mono		Left channel monaural recording.
4	MIC/LINE	Stereo	ON	Left/Right channel microphone level stereo recording. 48 volt phantom power is supplied for XLR inputs.
5			OFF	Left/Right channel microphone level stereo recording.
6			LINE	Left/Right channel line level stereo recording.
7		D.Mono	ON	Left/Left channel microphone level stereo recording. • The Left channel input is recorded in both Left and Right channels. The Right channel is attenuated by 20dB. 48 volt phantom power is supplied for XLR inputs.
8			OFF	Left/Left channel microphone level stereo recording. • The Left channel input is recorded in both Left and Right channels. The Right channel is attenuated by 20dB.
9			LINE	Left/Left channel line level stereo recording. • The Left channel input is recorded in both Left and Right channels. The Right channel is attenuated by 20dB.
10		Mono	ON	Left channel microphone level monaural recording. 48 volt phantom power is supplied for XLR inputs.
11			OFF	Left channel microphone level stereo recording.
12			LINE	Left channel line level monaural recording.
13		LINE2	Stereo	Invalid
14	D.Mono		Left/Left channel stereo recording. The Right channel is attenuated by 20dB. • The Left channel input is recorded in both Left and Right channels.	
15	Mono		Left channel monaural recording.	
16	D.IN	Stereo	Invalid	Left/Right channel stereo recording.
17		D.Mono		Left/Left channel stereo recording. • The Left channel input is recorded in both Left and Right channels.
18		Mono		Left channel monaural recording.

Recording Time Chart

All times are approximated record times.

Different media manufacturers allow more or less space for error correction and the like on their respective products.

Recording Time

Stereo channel

Settings	Bitrates	Recording Times (hours : minutes)					
		1GB	2GB	4GB	8GB	16GB	32GB
PCM-24 (96kHz)	4608kbps	0:30	0:59	1:59	3:57	7:54	15:48
PCM-24 (48kHz)	2304kbps	0:59	1:59	3:57	7:54	15:48	31:36
PCM-24 (44.1kHz)	2117kbps	1:04	2:09	4:18	8:36	17:12	34:24
PCM-16 (96kHz)	3072kbps	0:44	1:29	2:58	5:56	11:51	23:42
PCM-16 (48kHz)	1536kbps	1:29	2:58	5:56	11:51	23:42	47:24
PCM-16 (44.1kHz)	1411kbps	1:37	3:13	6:27	12:54	25:48	51:36
MP3-320	320kbps	7:07	14:13	28:27	56:56	113:47	227:33
MP3-256	256kbps	8:53	17:47	35:33	71:07	142:13	284:27
MP3-192	192kbps	11:51	23:42	47:24	94:49	189:38	379:16
MP3-128	128kbps	17:47	35:33	71:07	142:13	284:27	568:53
MP3-64	64kbps	35:33	71:07	142:13	284:27	568:53	1137:47

Monaural channel

Settings	Bitrates	Recording Times (hours : minutes)					
		1GB	2GB	4GB	8GB	16GB	32GB
PCM-24 (96kHz)	2304kbps	0:59	1:59	3:57	7:54	15:48	31:36
PCM-24 (48kHz)	1152kbps	1:59	3:57	7:54	15:48	31:36	63:13
PCM-24 (44.1kHz)	1058kbps	2:09	4:18	8:36	17:12	34:24	68:48
PCM-16 (96kHz)	1536kbps	1:29	2:58	5:56	11:51	23:42	47:24
PCM-16 (48kHz)	768kbps	2:58	5:56	11:51	23:42	47:24	94:49
PCM-16 (44.1kHz)	705kbps	3:13	6:27	12:54	25:48	51:36	103:12
MP3-320	160kbps	14:13	28:27	56:56	113:47	227:33	455:07
MP3-256	128kbps	17:47	35:33	71:07	142:13	284:27	568:53
MP3-192	96kbps	23:42	47:24	94:49	189:38	379:16	758:31
MP3-128	64kbps	35:33	71:07	142:13	284:27	568:53	1137:47
MP3-64	32kbps	71:07	142:13	284:27	568:53	1137:47	2275:33

Recording Level Control

The recording level control lets you select the type of input level Control.

– At the Manual Level Control

When Manual is set in the Level Control setting, adjust the **REC LEVEL** Control on the front panel of the PMD661MKII to control the audio input level. The optimum record level is when the level meter goes as close to 0dB as possible but does not go OVER.

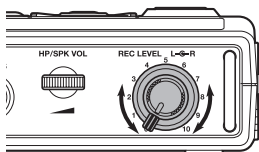

– At ALC (Automatic Level Control)

The PMD661MKII automatically responds to changes in input level. The **REC LEVEL** control does not work when the ALC is selected. Set the Level Control of the preset menu "ALC" (☞ P.47).

Encrypted Recording

When "Encrypt Rec" on the preset menu is set to "On", files recorded on SD cards are encrypted.

Encryption is performed based on the passcode (0000 to 9999) set at "Passcode" on the preset menu.

The correct passcode must be input to play files recorded with encrypted recording. (☞ P.26)

Files recorded with encrypted recording have the extension WAS for WAV files or MPS for MP3 files, according to the setting at "Rec Format" on the preset menu.

Use DMP Mark Editor to play files recorded with encrypted recording on a computer.

Retake Recording

The PMD661MKII is equipped with a retake recording function for recording over from any position in a file.

– Retake recording operation during recording

1. Press the **REC** button to begin recording.

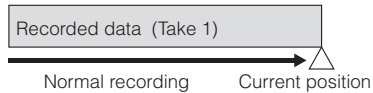

2. Press the **REC PAUSE** button to pause recording.

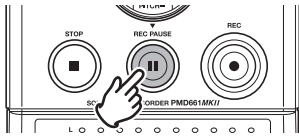

3. Press the **SKIP BACK** button to set the Retake Record mode.

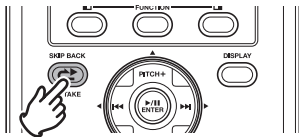

The recording position skips back the amount of time set at “Skip Back” on the preset menu and playback starts.



4. While monitoring the sound being played, find the position at which you want to start retake recording.

- Press the **▶/||/ENTER** button to pause playback.
- Press the **SKIP BACK**, **◀◀** or **▶▶** button to search for the desired playback position.
- The playing speed can be changed using the **PITCH-** and **PITCH+** buttons.

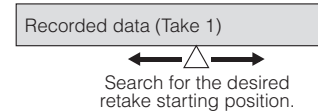

Press the **REC PAUSE** button to set the retake starting position.

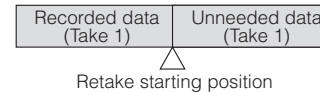
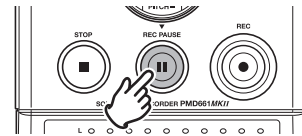

5. Press the **REC** button to start retake recording.

The unneeded data (Take 1) is deleted and Take 2 is recorded in its place.

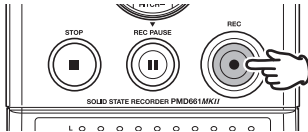

Retake recording Current position

- When recording of Take 2 starts, 0.5 seconds or the time set at “PreRecord” on the preset menu is prerecorded.

– **Retake recording operation during playback**

1. Press the **I◀◀** or **▶▶I** button to choose the file you wish to play.
2. Press the **▶||/ENTER** button to begin playback.

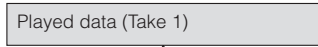

Current position

3. While monitoring the sound being played, find the position at which you want to start retake recording.

- Press the **▶||/ENTER** button to pause playback.
- Press the **SKIP BACK, I◀◀** or **▶▶I** button to search for the desired playback position.
- The playing speed can be changed using the **PITCH-** and **PITCH+** buttons.



Search for the desired retake starting position.

Press the **REC PAUSE** button to set the retake starting position.

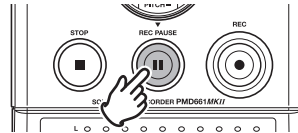

Retake starting position

4. Press the **REC** button to start retake recording.

The unneeded data (Take 1) is deleted and Take 2 is recorded in its place.

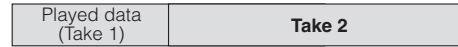
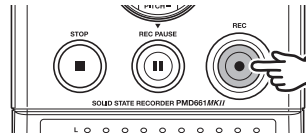

Retake recording Current position

- When recording of Take 2 starts, 0.5 seconds or the time set at “PreRecord” on the preset menu is prerecorded.

Basic Playback Operation

Connection Diagram

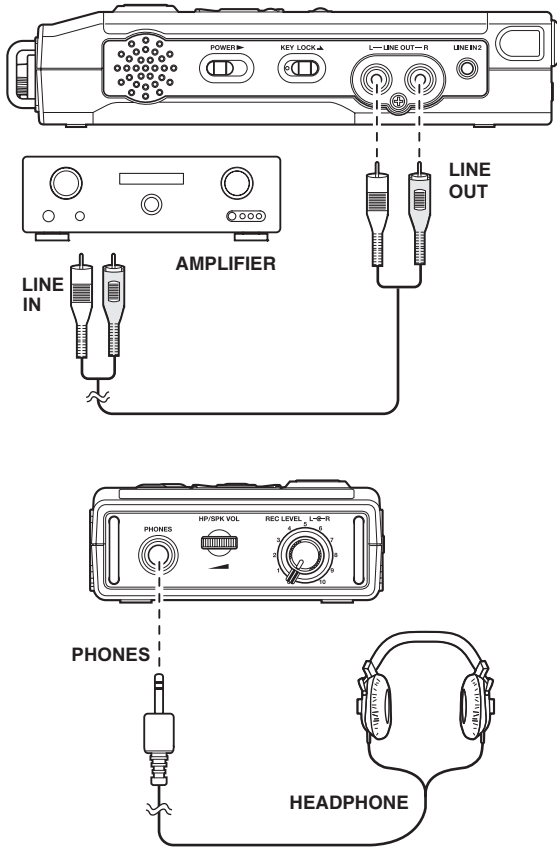

Caution:

To prevent hearing loss, do not raise the volume level excessively when using headphones.

Playback Procedure

1. Slide and hold the **POWER** switch to turn on.
2. Press the **◀◀** or **▶▶** button to choose the file you wish to play.

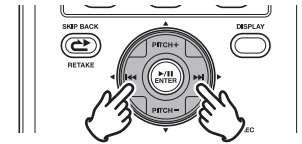

3. Press the **▶/||/ENTER** button to begin playback.

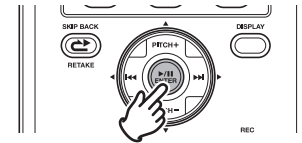

- When the selected file has been recorded with encrypted recording, the correct passcode must be input. (☞ P.26)
 - Files recorded with encrypted recording have the extension WAS for WAV files or MPS for MP3 files.
 - If an incorrect passcode is input, the file is not played.
4. Press the **▶/||/ENTER** button again to pause playback.

5. Press the **STOP** button to stop playback.

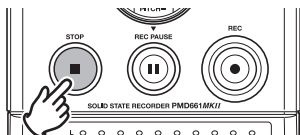

You can press the ►/||/ENTER button to play the just played file, or press the **STOP** button again to enter the Stop mode. Then pressing the ►/||/ENTER button will play the beginning of the first audio file.

Note:

The file sort order can be changed using the preset “File Sort”. (☞ P.52) When set to Alphabet, files are sorted in order of symbol, number, and alphabet. When set to “Time/Date”, audio files are sorted into the order in which they were created.

Access from File List

There are two ways to select the file you want to play. Either use the ◀◀ or ▶▶ buttons during Stop mode, or select the files from the File List.

1. From Stop, press the  (**F2: LIST**) button.

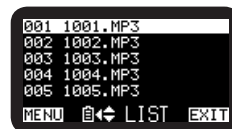

The file list appears on the display.

2. Press the **PITCH +** or **PITCH –** button to select the audio file. Then press the ►/||/ENTER button to enter the File list Menu.

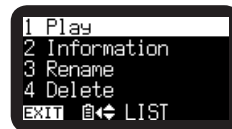

- When the selected file has been recorded with encrypted recording, the correct passcode must be input. (☞ P.26)
 - Files recorded with encrypted recording have the extension WAS for WAV files or MPS for MP3 files.
 - If an incorrect passcode is input, the file is not played.
3. Press the **PITCH +** or **PITCH –** button to select “Play”. Then press the ►/||/ENTER button to begin playback.
 - During playback, press the **STOP** button to return to the File list.

For accessing the files of other folder, ☞ P.62.

Search

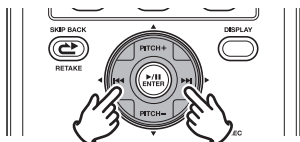

In Play-Pause mode, press and hold the **◀◀** or **▶▶** button for high speed searching without audio. 10X searching speed from 1 second to 4 seconds, and 140X speed over 4 seconds until release the button. When you release the button, the recorder returns to playback paused.

If the end of the file is passed with **▶▶** button still held down, search moves to the next file and continues searching in the forward direction.

If the tip of the file is passed with **◀◀** button still held down, search moves to the previous file and continues searching in the reverse direction.

During playback, press and hold the **◀◀** button to “rewind” and do a 2X speed audible search in the reverse direction. During playback, press and hold the **▶▶** button to “fast forward” and do a 2X speed audible search in the forward direction. Release to return to normal forward playback.

Skip Back

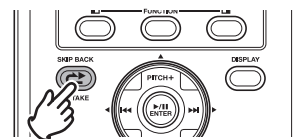

Press the **SKIP BACK** button during playback or pause to return the amount of time set in the preset Skip Back from the current playback or pause point. (👉 P.48)

When this button is pressed during the Rec-Pause mode, the Retake Record mode is set.

Passcode Input

The passcode between 0000 and 9999 that is set at “Passcode” must be input to make the “Menu Lock” and “Passcode” settings on the preset menu and to play files recorded with encrypted recording. When starting to make these settings or to play such files, the passcode input screen appears on the display and the character selected with the cursor flashes. By factory default, “0000” is displayed.

1. Press the **PITCH +** or **PITCH –** button to change the character.

- The number increases between 0 and 9 each time the **PITCH +** button is pressed, and decreases between 0 and 9 each time the **PITCH –** button is pressed.
- Press the **◀◀** or **▶▶** button to move the cursor.

2. Either press the **▶/II/ENTER** button or press the **▶▶** button with the cursor set at the last character to enter the passcode.

- Inputting can be cancelled by pressing the **STOP** button.

Note:

If you have forgotten the passcode, you can change it to “0000” by restoring the PMD661MKII to the factory defaults. (☞ P.67)

Advanced Features

Microphone(s)

– Attenuator

The microphone attenuation switch permits the direct use of microphones that differ in sensitivity.

- 0dB : No microphone attenuation.
- -6dB : Input from a microphone(s) connected to the MIC jack is cut by 6dB.
- -12dB : Input from a microphone(s) connected to the MIC jack is cut by 12dB.
- -18dB : Input from a microphone(s) connected to the MIC jack is cut by 18dB.

Setup the “Mic Atten.” of the preset menu. (👉 P.48)

– Phantom Power

Slide the PHANTOM/MIC switch to on to provide +48V of power for a condenser microphone(s).

ON : +48V is supplied to power condenser microphone(s).

OFF : No microphone power is supplied.

Microphone recommendations

Professional condenser microphone(s) (which require additional power from either the PMD661MKII's phantom power or from another source) are recommended because they provide greater sensitivity and higher quality audio recording.

Dynamic microphone(s) can be used, but they do not yield optimum audio quality recordings in some applications.

Consult with your local dealer to select the appropriate microphone(s) for your specific application. In many cases, they can demonstrate the various performances and characteristics of microphones for your use.

Pre Record

When PreRecord is on and the PMD661MKII is in record pause, it listens to the selected audio input(s) and continuously buffers 2 seconds of audio. Then, when record is started, the PMD661MKII writes the previously buffered 2 seconds of audio to the card and continues to record from there.

Setup the “PreRecord” of the preset menu. (👉 P.47)

Audio Filter

Low Cut Filter

The bass region of the input audio is cut as the audio is recorded.

Set to On to reduce noise, such as the sound of the wind when recording outdoors.

Setup the “Low Cut” of the preset menu. (👉 P.48)

High Cut Filter

The treble region of the input audio is cut as the audio is recorded.

Set to On to reduce high frequency noise from the ambient environment.

Setup the “High Cut” of the preset menu. (👉 P.48)

Silent Skip

The Silent Skip automatically pauses recording when there is a period of silence and resumes recording when sound resumes.

“Silent Skip” menu setting permits:

- Adjusting the margin sound level that defines silence in Off, -60dB, -54dB, -38dB, -20dB.

Setup the “Silent Skip” of the preset menu. (👉 P.48)

Manual Track

When the Manual Track (Manual Track incrementing) is on during recording, press the **FUNCTION** button until “TR” appears on the display, then press the  (**F1: TR**) button to increment the audio file. A new audio file is created at that point. The continuity of sound is not guaranteed and depends on the speed of a card or the audio file size.

Auto Track

With the Auto Track (Automatic Track incrementing) On, a new audio file is begun automatically at specified intervals of recording time. The Auto Track can be set to increment every 1, 5, 10, 15 or 30 minutes, or every 1, 2, 6, 8, 12 or 24 hours. The Auto Track makes finding a particular point in a recording easier. For example, if a new audio file begins every minute during playback, the Auto Track makes finding a particular passage easier because of the relationship between file numbers and time. During playback, you can select file number 3 to play approximately the 3rd minute of recording. To go directly to the beginning of the 10th minute, select file number 10, etc.

#	Recording time minutes : seconds
001.....	0:00 – 0:59
002.....	1:00 – 1:59
003.....	2:00 – 2:59

The continuity of sound is not guaranteed and depends on the speed of a card or the file size.

Setup the “Auto Track” of the preset menu. (P.47)

Note:

New audio file starts automatically when the recorded file size reaches 4GB.

Copy Segment

Copy Segment physically turns your “highlighted” section into a new and separate file, without destroying the original source file(s).

1. “COPY” is displayed during playback. Press the  (F1: COPY) button when the audio reaches your desired IN-point.

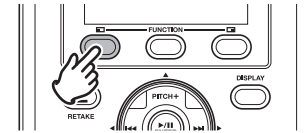

“Set as IN?” is displayed.

2. Press the  button to store the IN-point. “IN-” will flash on the display to indicate the IN-point has been stored and playback of the file resumes.

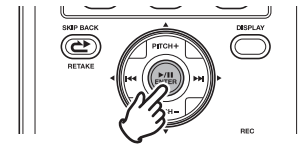

- Continue to let the PMD661MKII play to your desired OUT-point, or use the standard transport controls like the **◀◀** or **▶▶** button to span greater time lengths.
- When you have reached your desired OUT-point, press the **□ (F1: COPY)** button.

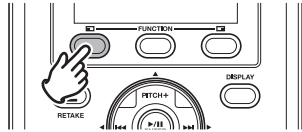

“Set as OUT?” is displayed.

- Press the **▶/||/ENTER** button to store the OUT-point.
“Copy Segment?” is displayed.
- Press the **▶/||/ENTER** button to start the Copy process.

“Executing...” will be shown on the display. When the copy procedure is completed, the display will show “Completed” for one second and then returns to stop mode with your new file as the current file.

Notes:

- When a copy area spans across two or more files, a file is connected and copied.
- When the copy area spans across files of different “Rec Format” or “Rec Channel” setting, it cannot be copied.
- The copy area cannot exceed 80 minutes.

File Divide

The File divide allows you to divide a file at the position you want to divide.

- During playback, press the **FUNCTION** button until “DIV” appears on the display. Then press the **□ (F1: DIV)** button.
 - “Divide?” appears on the display.
 - Select “No” and press the **▶/||/ENTER** button to pause the playback.
- Select “Yes” and press the **▶/||/ENTER** button to start Divide process.
“Executing...” will be shown on the display. When the divide process is completed, the display will show “Completed” for one second and the unit stops at the beginning of the second file of the divided files.

Notes:

- “_A” is added to the end of the file name of the first new file.
(For example; the original file=“aaa.mp3”, the first new file=“aaa_A.mp3”)
- “_B” is added to the end of the file name of the second new file.
- If the length of the file name with extension is already 63 or more, Divide process cannot be executed. “Long Title” message appears on the display and the playback is paused at the position you press the **▶/||/ENTER** button.

Marking

Marks can be added during recording or playback manually or automatically. The marking information is stored as an ID3 tag (Ver 2) in MP3 file or chunk in WAVE file. Marks help you find specific points in the recording.

- During playback, you can instantly locate marks.
- Up to 30 marks can be added to a file.
- Marks are numbered consecutively starting at one.
- During recording or playback, you can manually add a mark by pressing the **[F2: MARK]** button.

Add a mark manually

During recording or playback, press the **FUNCTION** button until "MARK" appears on the display. Then press the **[F2: MARK]** button to add a mark manually.

Add a mark automatically

The Auto Mark Menu item turns the automatic marking feature off or on. (☞ P.47)

- If Auto Mark is on and the machine is in Rec - Pause, when recording is resumed a mark will be added.
- If Auto Mark is on and the PMD661MKII is recording audio below the sound threshold for more than three seconds, audio that crosses the threshold will cause a mark to be added.

The Auto Mark Menu setting permits:

- Turning Auto Mark on or off.
- Adjusting the margin sound level that defines silence in -60dB, -54dB, -38dB or -20dB.

Setup the "Auto Mark" of the preset menu. (☞ P.47)

Search the marks

During play-pause or playback, press the **FUNCTION** button until "MK-" and "MK+" appear on the display. Then press the **[F1: MK-]** or **[F2: MK+]** button to select the mark you wish to access. The PMD661MKII is paused at the mark you selected.

To start playback, press the **[ENTER]** button.

Pitch Control

The Pitch Control enables the playback speed (pitch) to be varied over a -40% to +20% ranges.



During playback, press the **PITCH +** button to increase the playback speed by 5%. The playback speed is increased up to +20%. Or press the **PITCH -** button to reduce the playback speed by 5%. The playback speed is reduced to -40%.

Additional Features

Key Lock

Slide the **KEY LOCK** switch to lock the keys.

The key lock secures the PMD661MKII in the state it is in during recording, playback or stop.

During Record and Rec-Pause mode, the **POWER** switch is always invalid.

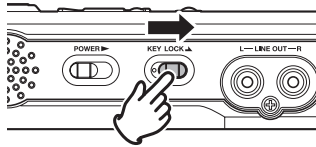

Notes:

- If “Key Lock” setting is “All”, only the optional remote controller RC600PMD is accepted.
- If “Key Lock” setting is “Partial”, the **REC**, **REC PAUSE** and **STOP** buttons on the panel, and RC600PMD are accepted.

Setup the “Key Lock” of the preset menu. (P.48)

- “Key Locked” is displayed for one second when the key is pressed during key lock.



Remote

The PMD661MKII allows you to use an optional remote controller RC600PMD. (sold separately). The RC600PMD is designed for microphone interviews. It attaches to your microphone.

The remote's five feet cord with a four contact mini plug, plugs into the PMD661MKII. The RC600PMD does not require any menu changes for use.

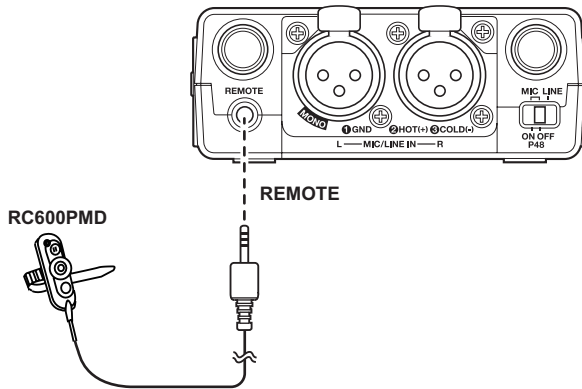

The RC600PMD includes:

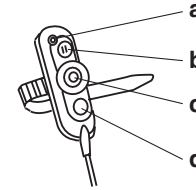

a An indicator light:

- (green) lit and steady during standby or stop
- (red) lit and steady while recording
- (flashing red) during Rec-Pause mode
- (orange) flashes for 1/2 second when an over peak level signal is input during Record or Rec-Pause mode, then it goes back to red.

b Press to pause recording

c Press to start/resume recording and to manually increment files

d Press to add a marking while Record or Playback.

Extended Remote Jack

The PLAY, FF and REW keys can be added to the remote control functions by using the equivalent circuit showing below.

Circuit diagram:

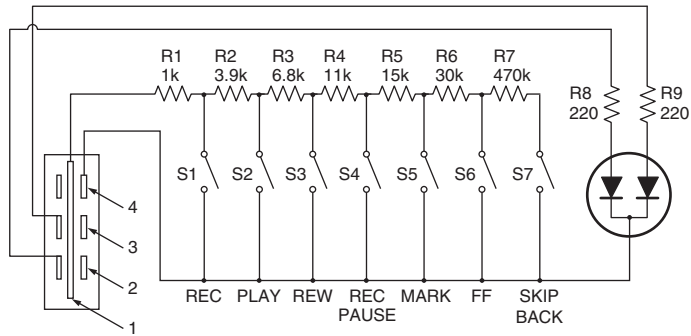

Notes:

- The PMD661MKII plays during closing and holding the PLAY switch, and skip back then pause at the point when it opened.
- Resistance error - Within 5%.
- Never apply external voltage. Doing so will result in malfunction.
- Insulate the circuit so that it cannot be touched directly. Use a structure that protects the circuit from static electricity, which will cause malfunction.
- Do not operate the switches at the same time as the buttons on the unit.
- D&M professional accepts no responsibility whatsoever for any damages or infringements of patents or other rights resulting from the use of the circuits.
- This does not sanction patents or other rights of D&M professional or third parties.
- It is strictly forbidden to reprint or reproduce the circuit diagrams in part or in whole.

Plug Type (1/8" T-R-R-S Mini Plug)

ø3.5/4P (TMP-B66)

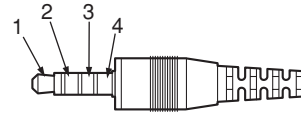

- 1: Tip
- 2: Ring
- 3: Ring
- 4: Sleeve

Display Control

Press the **DISPLAY** button to alternate information displays. Displays are slightly different in Stop, Record and Playback mode.

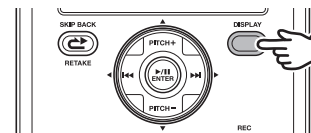

During Stop mode:

① Total Remain



② Current Time/Date



③ Record Setup



① Total Remain (Default display)

Remaining space of the card

Total remain time — 12:34:56

Input source — INT MIC

Number of files — 023 files

F1 function — MENU

F2 function — STOP LIST

Current time — 01:23AM

Current date — Mar23/2007

Input source — INT MIC

MENU STOP LIST

REC SETUP (Preset-1)

Input source — INT MIC

Rec format — MP3-192

Quantization — 16bit

ALC icon — ALC

Preset — Stereo

Rec channel — 192kbps

MP3 bitrate — 44.1kHz

Sample rate — AUTO TRK

AUTO TRACK icon

MENU STOP LIST

During Record mode:

① Record Time



② Total Remain Time



③ Record Level



④ Record Setup



① Record Time (Default display)

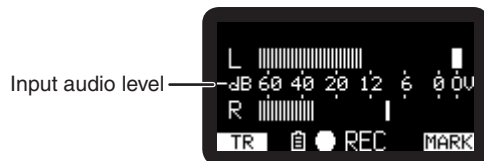
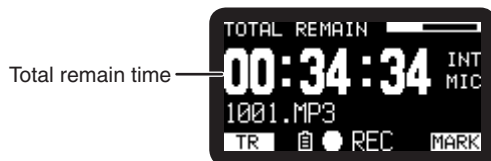

During Playback mode:

① Elapsed Time



② Remain Time



③ Output Level



④ File Properties



① Elapsed Time (Default display)

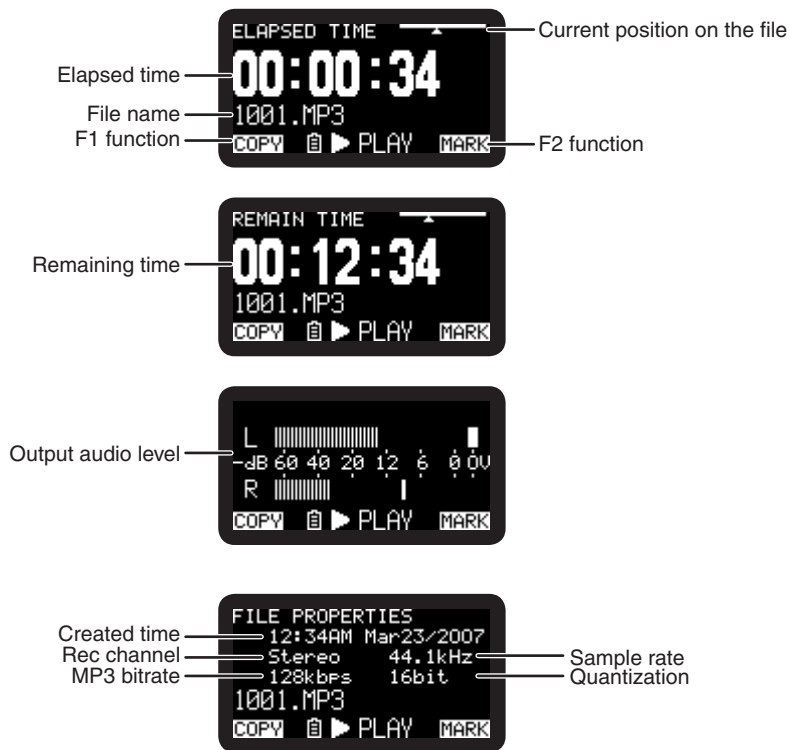

USB Mode

The PMD661MKII records directly onto SD cards. Recordings can then be transferred to your desktop or laptop computer by removing the SD card from the PMD661MKII, or by connecting the PMD661MKII to your computer via the USB port. Audio recorded in the popular MP3 compression format is directly available for intranet or internet file sharing.

Computer compatible

On your computer you can then:

- log and archive audio files
- play audio files
- save audio files to your drive

How to connect via the USB port

The SD card in the PMD661MKII appears as an external drive on a connected computer.

- 1.** Power up the computer.
- 2.** Insert an SD card.
- 3.** Power up the PMD661MKII.
- 4.** During Stop mode, connect the cable to the PMD661MKII and your computer.

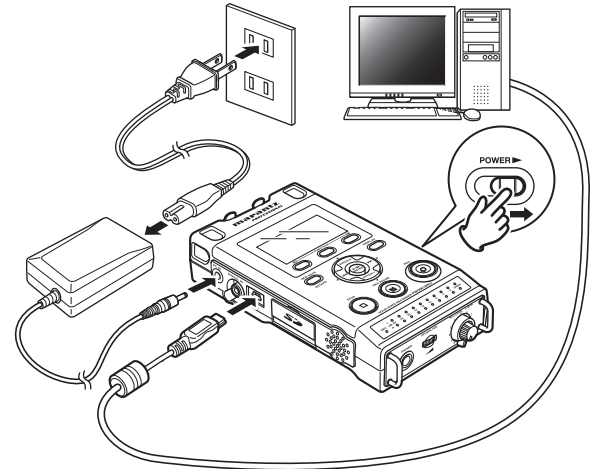

- While USB is on, a set screen is displayed.



- The SD card in the PMD661MKII appears as a removable device on your computer.

Notes:

- Check the operating system of your computer.
Windows XP, Vista, 7, MAC OS 10
- USB Bus Power activates this function even no service of AC adapter or batteries.
- No buttons other than the **POWER** switch function.

Caution:

- Do not remove the SD card during USB mode. The Data and the SD card may be damaged.
- During recording and playback, do not connect the cable to the PMD661MKII and your computer. The PMD661MKII may turn itself off or stop, by the USB Bus Power condition.

Diagram of file structure

A folder (directory) titled MPGLANG1 (Default) will appear on your computer. Files within the MPGLANG1 folder are numbered from aaaaa001 through the number of files recorded to a maximum of aaaaa999. (“aaaaa” depends on the Machine ID parameter.) The default setting of the Machine ID is “1”. The file extension will be .MP3 or .WAV depending on the “Rec Format” parameter that is set for the recording.

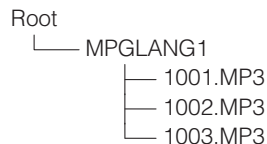

Changes made to file names or structures on your computer will prevent file recognition and playback in the PMD661MKII.

Machine ID

An audio file created by the PMD661MKII has Machine ID information. The information is included in a file name. For example, if the Machine ID is “1”, the first file is numbered “1001.WAV” or “1001.MP3”. Setup the “Machine ID” of the preset menu. (P.50)

Menu

Menu Structure

1 Presets		Preset-1	1 Select	
2 Display.....	01 Brightness	Preset-2	2 Edit.....	01 Input
3 Time/Date	02 Timer	Preset-3	3 Rename	02 Rec Format
4 Utility.....	1 Record Timer			03 Rec Channel
5 Language	2 Play Timer1			04 Sample Rate
6 F/W Version	3 Play Timer2			05 PreRecord
	4 Play Timer3			06 Level Cont.
	5 Load Settings			07 Auto Track
	6 Save Settings			08 Auto Mark
	7 Card Check			09 Silent Skip
	8 Card Format			10 Mic Atten.
				11 Low Cut
				12 High Cut
				13 Skip Back
				14 Key Lock
				15 Battery
				16 Auto Power Off
				17 Beep
				18 Encrypt Rec
				19 Menu Lock
				20 Passcode
				21 SP Mute
				22 Play Mode
				23 Machine ID
				24 Preset Default

Top Menu

1. From Stop, press the  (F1: MENU) button.



- The menu list appears on the display.
 - The selected item is highlighted.
 - When the first item is selected, press the **PITCH +** button to jump to the last item.
 - When the last item is selected, press the **PITCH –** button to jump to the first item.
2. Press the **PITCH +** or **PITCH –** button to select the item.
 3. Press the **▶/||/ENTER** button to confirm or execute the selected item.

Items and functions

#	Display	Description
1	Presets	Go to the Preset Menu.
2	Display	Go to the Display Menu.
3	Time/Date	Adjust the date and time.
4	Utility	Go to the Utility Menu.
5	Language	Choose the display language.
6	F/W Version	Display the software version.

Protecting the Menu Settings

When “Menu Lock” on the preset menu is set to “On”, the passcode is required to select items below the top menu, thereby protecting the settings.

The passcode is the number from 0000 to 9999 set at “Passcode” on the preset menu. (👉 P.26)

Preset Menu

You can store 3 detailed presets on the recorder for such settings as recording input, recording format, playback mode, etc. There are 20 setting items in the preset menu, and 3 presets can be set with the desired conditions.

“Preset Select” allows you to select a preset number.

1. From Stop, press the  (F1: MENU) button.
2. Press the **PITCH +** or **PITCH –** button to select “Presets”. Then press the **▶/||/ENTER** button.

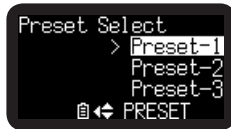

3. Press the **PITCH +** or **PITCH –** button to select Preset 1, 2, 3 or renamed Preset.

4. Press the **▶/||/ENTER** button to accept the selected Preset.

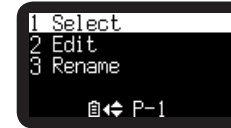





- Action Menu appears on the display.
- Select “Select” item and press the **▶/||/ENTER** button to store the settings of the selected preset.
- Select “Edit” item and press the **▶/||/ENTER** button to set or change the selected preset.
- Select “Rename” item and press the **▶/||/ENTER** button to change the name of the selected preset.

Action Menu Functions



#	Display	Description
1	Select	Store the settings of the selected preset.
2	Edit	Set or change the selected preset.
3	Rename	Change the title of the selected preset.

Preset Rename

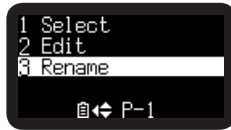
1. From Stop, press the  (F1: MENU) button.
2. Press the **PITCH +** or **PITCH –** button to select Preset Menu. Then press the /ENTER button to accept.
3. Press the **PITCH +** or **PITCH –** button to select Preset 1, 2, 3 or renamed Preset.
Then press the /ENTER button to accept the selected Preset.
4. Press the **PITCH +** or **PITCH –** button to select “Rename” and press the /ENTER button to accept.



5. Rename the preset title.

Text can be changed and deleted. Press the  or  button to move the cursor to the place you wish to change text or delete text from.

To change the letter

Press the **PITCH +** or **PITCH –** button to select the character you want to change.

To insert a letter

Press the  (F1: INS) button. A character is inserted into the left of the highlighted character and then it will be highlighted.

To delete the letter

Press the  (F2: DEL) button to delete the selected character.

6. Press the /ENTER button to store the changes.

Press the  button to go back the previous page without store the changes when the first letter of the preset title is highlighted.

Notes:

- If the last letter of the preset title is Space(SP) character, the changed title does not include the last letter.
- The maximum length of a preset title is limited to 8 letters. When the 9th letter is inserted the last letter is deleted.
- The characters which you can insert are A B C D E F G H I J K L M N O P Q R S T U V W X Y Z a b c d e f g h i j k l m n o p q r s t u v w x y z (Space) ! " # \$ % & ' () + , - . ; = @ [] ^ _ ` { } ~ 0 1 2 3 4 5 6 7 8 9.

Preset Menu List

#	Display	Selectable Value
1	Input	INT MIC / MIC/LINE / LINE2 / D.IN
2	Rec Format	MP3-320 / MP3-256 / MP3-192 / MP3-128 / MP3-64 / PCM-16 / PCM-24
3	Rec Channel	Stereo / Mono / D.Mono
4	Sample Rate	44.1k / 48k / 96k
5	PreRecord	On / Off
6	Level Cont.	Manual / ALC
7	Auto Track	Off / 1min / 5min / 10min / 15min / 30min / 1hour / 2hour / 6hour / 8hour / 12hour / 24hour
8	Auto Mark	Off / -60dB / -54dB / -38dB / -20dB
9	Silent Skip	Off / -60dB / -54dB / -38dB / -20dB
10	Mic Atten.	0dB / -6dB / -12dB / -18dB
11	Low Cut	On / Off
12	High Cut	On / Off
13	Skip Back	0.5sec / 1sec / 1.5sec / 2sec / 2.5sec / 3sec / 3.5sec / 4sec / 4.5sec / 5sec / 5.5sec / 6sec / 6.5sec / 7sec / 7.5sec / 8sec / 8.5sec / 9sec / 9.5sec / 10sec / 15sec / 20sec / 25sec / 30sec / 35sec / 40sec / 45sec / 50sec / 55sec / 60sec
14	Key Lock	All / Partial
15	Battery	Alkaline / Ni-MH
16	Auto Power Off	Off / 5m / 15m / 30m / 60m
17	Beep	On / Off
18	Encrypt Rec	On / Off
19	Menu Lock	On / Off
20	Passcode	4-digit number
21	SP Mute	On / Off
22	Play Mode	Single / Cont.
23	MachineID	Max 8 letters
24	Preset Default	

Default Value List

#	Display	Preset-1	Preset-2	Preset-3
1	Input	INT MIC	INT MIC	INT MIC
2	Rec Format	MP3-128	MP3-320	PCM-24
3	Rec Channel	Stereo	Stereo	Stereo
4	Sample Rate	44.1k	44.1k	96k
5	PreRecord	On	Off	Off
6	Level Cont.	ALC	Manual	Manual
7	Auto Track	Off	Off	Off
8	Auto Mark	Off	Off	Off
9	Silent Skip	Off	Off	Off
10	Mic Atten.	0dB	0dB	0dB
11	Low Cut	On	Off	Off
12	High Cut	On	Off	Off
13	Skip Back	3sec	3sec	3sec
14	Key Lock	All	All	All
15	Battery	Alkaline	Alkaline	Alkaline
16	Auto Power Off	15m	15m	15m
17	Beep	On	On	On
18	Encrypt Rec	Off	Off	Off
19	Menu Lock	Off	Off	Off
20	Passcode	0000	0000	0000
21	SP Mute	Off	Off	Off
22	Play Mode	Cont.	Cont.	Cont.
23	MachineID	1	1	1
24	Preset Default	Meeting Compressed	Music Compressed	Highest Quality Uncompressed

General Procedure in the edit mode

1. In the Preset Action Menu, press the **PITCH+** or **PITCH-** button to select “Edit” then press the **▶/||/ENTER** button.
 - Action Menu list appears on the display.
2. Press the **PITCH+** or **PITCH-** button to select the menu item. Then press the **I◀◀** or **▶▶I** button to select the input choices.
3. When changing the preset is completed, press the **□ (F1: EXIT)** button.
 - “Store?” appears on the display.
4. Select “Yes” and press the **▶/||/ENTER** button to store the changes or select “No” and press the **▶/||/ENTER** button to exit Menu Mode without storing any changes.

1) Input

Use this menu to select the audio input for recording.

Set Value	Description
INT MIC	Internal stereo microphones
MIC/LINE	External microphone(s) (MIC/LINE Jack)
LINE2	Line Level Input (LINE 2 Jack)
D.IN	Digital Input

2) Rec Format

The “Rec Format” allows you to select the record audio format MP3 compression or high-fidelity PCM, the bitrate of the MP3 (320, 256, 192, 128 or 64 kbps) and the quantization of the PCM (16-bits or 24-bits).

Set Value	Description
MP3-320 / MP3-256 / MP3-192 / MP3-128 / MP3-64	(MP3) Mono : 160, 128, 96, 64, 32kbps Stereo: 320, 256, 192, 128, 64kbps
PCM-16 / PCM-24	(PCM) Quantization: 16bits, 24bits

3) Rec Channel

The “Rec channel” allows you to select the record channel(s) from stereo 2-channel or monaural 1-channel or stereo 2-channel with dual mono.

Set Value	Description
Stereo	Stereo 2-channel audio file
Mono	Monaural audio file
D.Mono	Stereo 2-channel audio file. The left channel input is recorded in both channels.

4) Sample Rate

The “Sample Rate” allows you to select the sampling frequency of the recording.

Set Value	Description
44.1k	Sampling frequency for both PCM and MP3.
48k	Sampling frequency for both PCM and MP3.
96k	Sampling frequency for PCM.

5) PreRecord

The “PreRecord” allows you to turn on or off the pre record function.

Set Value	Description
On	Set the PreRecord on.
Off	Set the PreRecord off.

6) Level Cont. (Level Control)

The “Level Cont.” allows you to select the type of recording level control, Manual or ALC.

Set Value	Description
Manual	Manual Level Control
ALC	Automatic Level Control

7) Auto Track

The “Auto Track” allows you to set the Auto Track function off or on and select a time interval to create a new track automatically.

Set Value	Description
Off	Set the Auto Track function off.
1min / 5min / 10min / 15min / 30min / 1hour / 2hour / 6hour / 8hour / 12hour / 24hour	Set the Auto Track function on and the time interval to create a new file.

8) Auto Mark

The “Auto Mark” menu item allows you to turn the auto mark function on and set the silent level or turn the auto mark feature Off. The Mark is automatically added after the end of the silent period of which the input level is below the preset value -60, -54, -38 or -20 (dB) for more than 3 seconds.

Set Value	Description
Off	Auto mark function off.
-60dB / -54dB / -38dB / -20dB	Silent level

9) Silent Skip

The “Silent Skip” menu item allows you to turn the silent skip feature on and set the silent level or turn the silent skip feature Off. While the silent skip feature is on, the record is automatically paused when the input level is below the preset value -60, -54, -38 or -20 (dB) for more than 3 seconds.

Set Value	Description
Off	Set the Silent Skip feature off.
-60dB / -54dB / -38dB / -20dB	Set the Silent Skip feature on and select the silent level.

10) Mic Atten. (Mic Attenuator)

The “Mic Atten.” menu item allows you to select the level of the Microphone Attenuator.

Set Value	Description
0dB	Set the Mic Attenuator feature off.
-6dB / -12dB / -18dB	Set the Mic Attenuator.

11) Low Cut

The “Low Cut” menu item turns the low cut feature Off or On.

Set Value	Description
Off	Low cut filter off.
On	Low cut filter on.

12) High Cut

The “High Cut” menu item turns the high cut feature Off or On.

Set Value	Description
Off	High cut filter off.
On	High cut filter on.

13) Skip Back

The “Skip Back” menu item allows you to select the skip back time from 0.5 second to 60 seconds.

Set Value
0.5sec / 1sec / 1.5sec / 2sec / 2.5sec / 3sec / 3.5sec / 4sec / 4.5sec / 5sec / 5.5sec / 6sec / 6.5sec / 7sec / 7.5sec / 8sec / 8.5sec / 9sec / 9.5sec / 10sec / 15sec / 20sec / 25sec / 30sec / 35sec / 40sec / 45sec / 50sec / 55sec / 60sec

14) Key Lock

The key lock secures the PMD661MKII in the state it is in during Record, Playback or Stop.

Set Value	Description
All	All buttons are invalid.
Partial	All buttons are invalid. But the REC , REC PAUSE and STOP/CANCEL buttons are accepted.

15) Battery

The "Battery" menu item allows you to set the battery type. The PMD661MKII operates on 4 standard AA sizes Alkaline or Ni-MH batteries. The Battery setting is used for the battery remaining indicator in the display and "Low Battery" warning. If the setting does not match installed batteries the PMD661MKII will not show the appropriate battery status.

Set Value	Description
Alkaline	Set the battery type to Alkaline battery.
Ni-MH	Set the battery type to Nickel-Metal Hydride battery.

16) Auto Power Off

If the PMD661MKII is not operated for a long period of time during Stop or Play-Pause mode, the power can be automatically shut off to conserve battery life.

Set Value	Description
Off	Set the auto power off feature off.
5m / 15m / 30m / 60m	Set the feature on and select the time until the PMD661MKII turns power off automatically.

17) Beep

The "Beep" menu item allows you to turn the Beep alarm feature On or Off. While the feature is on, the unit beeps when the battery power becomes low (low battery) or recording space is not remained in the SD card.

Set Value	Description
On	Set the Beep feature on.
Off	Set the Beep feature off.

18) Encrypt Rec

The "Encrypt Rec" menu item allows you to set encrypted recording. When the "Encrypt Rec" is turned on, recorded files are encrypted.

Set Value	Description
On	Turns encrypted recording on.
Off	Turns encrypted recording off.

19) Menu Lock

The "Menu Lock" menu item allows you to protect the setting items below the top menu by password.

Set Value	Description
On	Enables protection by password.
Off	Disables protection by password.

20) Passcode

This is the encryption key used for encrypted recording. When the “Menu Lock” is turned on, it is also used as the password.

Set Value
4-digit number from 0000 to 9999 (initially set to 0000)

21) SP Mute

The “SP Mute” allows you to select speaker mute function On or Off. When “SP Mute” is set to On, the sound being recorded is not output from the speaker. When set to Off, the sound is output from the speaker except when the sound is being recorded by the built-in microphone.

Set Value	Description
On	Speaker Mute On.
Off	Speaker Mute Off.

22) Play Mode

The “Play Mode” menu item allows you to select the single playback mode or continuous playback mode.

Set Value	Description
Single	Single playback mode
Cont.	Continuous playback mode

23) Machine ID

An audio file created by the PMD661MKII has Machine ID information. The information is included in the file name.

For example, if the Machine ID is “aaaaa”, the first file is numbered “aaaaa001.wav” or “aaaaa001.mp3”.

The Machine ID setting applies to all three presets.

1. In the preset edit mode, press the **PITCH +** or **PITCH –** button to select the “MachineID” item. Then press the **▶/||/ENTER** button to rename.
2. Rename the Machine ID.
Refer to the procedure of the “Preset Rename” (🔍 P. 43).
3. Press the **▶/||/ENTER** button to return to the preset select menu then press the **🔍 (F1: EXIT)** button to store the changes.

Notes:

- If Last letter of the Machine ID is Space(SP) character, the changed ID does not include the last letter.
- If number of letter is more than 8, last letter is deleted when a new letter is added.

24) Preset Default

The “Preset Default” allows you to return the settings of the selected preset to default.

🔍 P.45 for a table of menu defaults.

1. In the preset edit mode, press the **PITCH +** or **PITCH –** button to select the “Preset Default” item. Then press the **▶/||/ENTER** button to initialize.
2. While “Default?” message is displayed, select “Yes” and then press the **▶/||/ENTER** button. Preset value returns to the default and the PMD661MKII starts writing on non-volatile memory.

Display Menu

You can store presets on the display menu for such settings as Brightness, Timer, LED, Time form, Date form and File sort.

1. From Stop, press the **⏏ (F1: MENU)** button.
 - Menu list appears on the display.
 - The selected item is highlighted.
 - When the first item is selected, press the **PITCH +** button to jump to the last item.
 - When the last item is selected, press the **PITCH –** button to jump to the first item.
2. Press the **PITCH +** or **PITCH –** button to select “Display”.



3. Press the **▶/||/ENTER** button.
 - The number of a selected item blinks.
 - The choice of the selected item is highlighted.
 - During display menu mode, press the **STOP** button to return to the stop mode.

4. Press the **PITCH +** or **PITCH –** button to select an item.
Then press the **◀◀** or **▶▶** button to tab through the choices.
5. Press the **PITCH +** or **PITCH –** button to select other menu choices. When changing the display menu is complete, press the **⏏ (F1: EXIT)** button to store the changes, or press the **STOP** button to exit menu mode without storing any changes.
6. While “Store?” is displayed, select “Yes” and press the **▶/||/ENTER** button to store the changes or select “No” and press the **▶/||/ENTER** button to return to top menu without storing any changes.

Display Menu Functions

#	Display	Selection items	Default
1	Brightness	1 to 8	5
2	Timer	Off/30sec/60sec/90sec	Off
3	LED	On/Off	On
4	Time Form	12H/24H	12H
5	Date Form	M/D/Y, D/M/Y	M/D/Y
6	File Sort	Alphabet, Time/Date	Time/Date
7	Default	--	--

* Factory default of “Date Form” setting for Europe is “D/M/Y”.

1) Brightness

The “Brightness” menu choice allows you to adjust the brightness of the OLED (Organic Light-Emitting Diode) display on the PMD661MKII.

Set Value	Description
1, 2, 3, 4, 5, 6, 7, 8	(Dark) 1 – 8 (Bright)

2) Timer

The “Timer” menu item allows you to set the timer function off or on with preset time. While the Timer is on, the part of display items will be turned off automatically when no button is pressed for preset time (30, 60 or 90 seconds). The battery life will be extended if it is on.

Set Value	Description
Off	Set the Timer Off.
30sec/60sec/90sec	Set the Timer On and time.

3) LED

The “LED” menu choice allows you to turn on or off the light of all LEDs.

Set Value	Description
On	Turn the LED On.
Off	Turn the LED Off.

4) Time Form

The “Time Form” item allows you to select the format of the current time, 12-hour format with AM/PM (12H) or 24-hour format (24H).

Set Value	Description
12H	12-hour format (12:00AM – 11:59PM)
24H	24-hour format (00:00 – 23:59)

5) Date Form

The “Date Form” item allows you to set the date order month/day/year (M/D/Y) or day/month/year (D/M/Y).

Set Value	Description
M/D/Y	Month /Day /Year
D/M/Y	Day /Month /Year

6) File Sort





The “File Sort” menu choice allows you to select the file order in the list by name (Alphabet) or time (Time/Date).

Set Value	Description
Alphabet	
Time/Date	

7) Default

The “Default” menu item allows you to return the settings of the Display Menu to the default.

See the table of Display Menu Functions.



1. From Stop, press the  (**F1: MENU**) button.
2. Press the **PITCH +** or **PITCH –** button to select Display Menu. Then press the /**ENTER** button to accept.
3. Press the **PITCH +** or **PITCH –** button to select the Default item. Then press the /**ENTER** button to initialize.
4. While “Default?” message is displayed, select “Yes” and then press the /**ENTER** button, then preset value returns to the default and to start writing on non-volatile memory.

Utility Menu

The record and play timer settings, the setting data load and save functions and the SD card format and card writing performance can be checked on the “Utility” menu.

1. From Stop, press the  (**F1: MENU**) button.
2. Press the **PITCH +** or **PITCH –** button to select “Utility”.



3. Press the /**ENTER** button.
 - During Utility menu mode, press the **STOP** button to return to the stop mode.
4. Press the **PITCH +** or **PITCH –** button to select the menu item. Press the /**ENTER** button to enter the menu item.

Utility Functions

#	Display	Description
1	Record Timer	Set a start time and the duration for recording.
2	Play Timer 1	Set a start time of playback 1.
3	Play Timer 2	Set a start time of playback 2.
4	Play Timer 3	Set a start time of playback 3.
5	Load Settings	Load setting data from an SD card
6	Save Settings	Save setting data to an SD card
7	Card Check	Check the SD card writing performance.
8	Card Format	Delete all files.

1) Record Timer

The Record Timer menu allows you to set or change a recording start time and the duration.

1. Select the Record Timer menu.

- When in stop, press the  (**F1: MENU**) button.
- Press the **PITCH +** or **PITCH -** button until “Utility” appears, then press the **▶/||/ENTER** button.
- Press the **PITCH +** or **PITCH -** button until “Record Timer” appears, then press the **▶/||/ENTER** button.

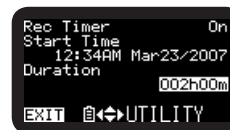

2. Set the Record Timer On or Off.

- Press the **PITCH +** or **PITCH -** button until “On” or “Off” is highlighted. Then press the **◀◀** or **▶▶** button until “On” is highlighted to turn on the Record Timer function. Press the **◀◀** or **▶▶** button until “Off” is highlighted to turn off the Record Timer function.
- Press the **PITCH +** or **PITCH -** button to move to the other item. The selected item is highlighted.

3. Set the start time.

- While the “Start Time” is highlighted, press the ►/||/ENTER button.
- Press the ◀◀◀ or ▶▶▶ button to select the item.
- Press the **PITCH +** or **PITCH –** button to select the value.
- Press the **ENTER** button to finish setting the time.

4. Set the duration.

- While the “Duration” is highlighted, press the ►/||/ENTER button.
- Press the ◀◀◀ or ▶▶▶ button to select the hour or minute.
- While the hour is highlighted press the **PITCH +** or **PITCH –** button to select the hour from 000 to 999.
- While the minute is highlighted press the **PITCH +** or **PITCH –** button to select the minute from 00 to 59.

5. Store the changes.

- During setting, press the ◻ (F1: EXIT) button. “Store?” appears on the display. Select “Yes” to store the setting and return to Utility menu. Or select “No” to return to the Utility menu without storing any changes.
- During setting, press the **STOP** button to return to the stop mode without storing any changes.
- While the timer is set, “T” icon appears on the display.



“T” icon

2/3/4) Play Timer (1/2/3)

The “Play Timer” menu allows you to set or change a start time for playback and the filename of the playback file.

1. Select the Play Timer menu.

- When in stop, press the ◻ (F1: MENU) button.
- Press the **PITCH +** or **PITCH –** button until “Utility” appears, then press the ►/||/ENTER button.
- Press the **PITCH +** or **PITCH –** button until “Play Timer 1 (or 2 or 3)” appears and then press the ►/||/ENTER button.

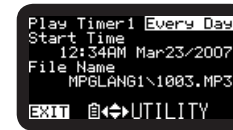

2. Set the Play Timer.

- Press the **PITCH +** or **PITCH –** button until “Everyday”, “Weekday” or “Weekend” is highlighted.
- Press the ◀◀◀ or ▶▶▶ button until “Weekday” is highlighted to set the playback from Monday to Friday.
- Press the ◀◀◀ or ▶▶▶ button until “Weekend” is highlighted to set the playback on Saturday and Sunday.
- Press the **PITCH +** or **PITCH –** button to move to the other item. The selected item is highlighted.

3. Set the start time.

- While the “Start Time” is highlighted, press the ►/||/ENTER button.
- Press the ◀◀ or ▶▶ button to select AM/PM, hour or minute.
- Press the ◀◀ or ▶▶ button to select the item.
- Press the **PITCH +** or **PITCH –** button to select the value.
- Press the **ENTER** button to finish setting the time.

4. Select the file.

- While the “File Name” is highlighted, press the ►/||/ENTER button.



- The file list appears on the display.
- Press the **PITCH +** or **PITCH –** button to select the file you wish to play. Then press the ►/||/ENTER button.

5. Store the changes.

- During setting, press the **F1: EXIT** button. “Store?” appears on the display. Select “Yes” to store the setting and return to Utility menu. Or select “No” to return to the Utility menu without storing any changes.
- During setting, press the **STOP** button to return to the stop mode without storing any changes.

5) Load Settings

The “Load Settings” menu allows you to load all of the preset value from an SD card in the PMD661MKII.

When performing load settings, use an SD card in which the preset contents from Save Settings are stored.

This function is particularly useful when setting multiple PMD661MKIIs with the same settings.

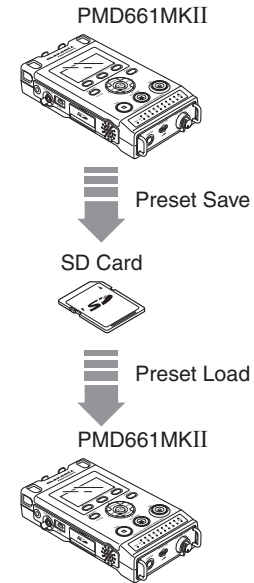

1. From Stop, press the  (F1: MENU) button.
2. Press the **PITCH +** or **PITCH –** button to select “Utility”.
Then press the **▶/||/ENTER** button to accept.
3. Press the **PITCH +** or **PITCH –** button to select “Load Settings”.
4. Press the **▶/||/ENTER** button. “Load?” message is displayed.
 - Press the **STOP** button to cancel loading items and return to the stop mode.
5. While “Load?” message is displayed, select “Yes” and press the **▶/||/ENTER** button to load the setting value in text format from the file in a route folder on card. The title of the file load is “661preset2.txt”. During load settings, it displays “Executing...”. After the file load is completed, “Completed” is displayed for one second and returns to Stop mode.

6) Save Settings

“Save Settings” saves all of the preset values onto the SD card. To set the saved files onto the PMD661MKII, perform Load Settings.

1. From Stop, press the  (F1: MENU) button.
2. Press the **PITCH +** or **PITCH –** button to select “Utility”.
Then press the **▶/||/ENTER** button to accept.
3. Press the **PITCH +** or **PITCH –** button to select “Save Settings”.
4. Press the **▶/||/ENTER** button. “Save?” message is displayed.
 - Press the **STOP/CANCEL** button to cancel saving item and return to the stop mode.
5. While “Save?” message is displayed, select “Yes” and press **▶/||/ENTER** button to output preset value in text format into the file in a route folder on card. The title of the file output is “661preset2.txt”. During preset output, “Executing...” is displayed. After the file output is completed, “Completed” is displayed for one second and returns to Stop mode.

7) Card Check

The “Card Check” checks the writing performance of the SD card being used and displays the results, as shown below.

Display	Description
Good	Recording is possible without problems.
Poor	Writing problems may occur during recording. It is recommended you use a different SD card.

Notes:

- Do not turn the power off or open the SD card compartment’s lid while the card is being checked. Doing so could damage the card or data. Also, it is recommended you use the AC adapter when checking the card.
- The check results are for reference purposes only; they do not guarantee operation.

8) Card Format

1. From Stop, press the  (F1: MENU) button.
2. Press the **PITCH +** or **PITCH –** button to select “Utility”. Then press the **▶/II/ENTER** button.
3. Press the **PITCH +** or **PITCH –** button to select “Card Format”. Then press the **▶/II/ENTER** button.
 - “Card Format?” message is displayed.
 - Press the **STOP** button to cancel a Card Format item and return to STOP.
4. While “Card Format?” message is displayed, select “Yes” and press the **▶/II/ENTER** button to format the SD card. During formatting, “Executing...” is displayed. After displaying “Completed” for a second, PMD661MKII return to the stop mode.

File format of the 661preset2.txt

Item	Separator	Set Value	Break
[Preset-1]		Fixed value	0D0Ah
Name	=		0D0Ah
Input	=		0D0Ah
:	:	:	:
Play Mode	=		0D0A0D0A h
[Preset-2]		Fixed value	0D0Ah
Name			0D0Ah
Input	=		0D0Ah
:	:	:	:
Play Mode	=		0D0A0D0A h
[Preset-3]		Fixed value	0D0Ah
Name			0D0Ah
Input	=		0D0Ah
:	:	:	:
Play Mode	=		0D0A0D0A h
[Display]		Fixed value	0D0Ah
Brightness			0D0Ah
:	:	:	:
File Sort			0D0A0D0A h
[Common]		Fixed value	0D0Ah
Machine ID	=		0D0Ah
Version	=		0D0Ah

File List Menu

The file list displays a list of file titles, MP3 and WAV in 'MPGLANG1' or other folders. The list can be used to play, rename or delete the selected file or check the information of the file.

1. From Stop, press the  (**F2: LIST**) button.



- The file list appears on the display.
- The selected item is highlighted.
- When the first item is selected, press the **PITCH +** button to jump to the last item.
- When the last item is selected, press the **PITCH -** button to jump to the first item.
- Press the  to enter the Folder list.

2. Press the **PITCH +** or **PITCH -** button to select the file you want to access. Then press the /**ENTER** button to enter the File list Menu.



- During file list menu mode, press the **STOP** button to return to the stop mode.

File List Menu Functions

#	Display	Description
1	Play	Play the file.
2	Information	Display information of the file.
3	Rename	Rename the file title.
4	Delete	Delete the file.
5	Copy	Make a copy of a file in another folder.
6	Move	Move the from the current folder to another folder.
7	Delete Marks	Delete mark(s) in the selected file.

1) Play

The “Play” menu item allows you to play the selected file.

1. In the file list menu, press the **PITCH +** or **PITCH –** button to select “Play”.

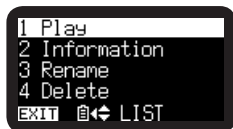

2. Press the **▶/||/ENTER** button to start playback.
 - Press the **STOP** button to stop playback and return to File List.

2) Information

The “Information” menu item allows you to display the information of the selected file.

1. In the file list menu, press the **PITCH +** or **PITCH –** button to select “Information”.

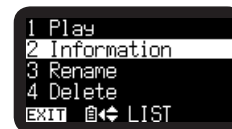

2. Press the **▶/||/ENTER** button to display the information.



- Press the **I◀◀** button to return to the File list Menu.
- Press the **STOP** button to return to the stop mode.

3) File Rename

The “Rename” menu item allows you to change the file name of the selected file.

1. In the file list menu, press the **PITCH +** or **PITCH –** button to select “Rename”.



2. Press the **▶/||/ENTER** button to access the rename window.
3. Rename the file title.
Refer to the procedure of the “Preset Rename (🔍 P. 43).
4. Press the **▶/||/ENTER** button to store the changes.
Press the **◀◀** button to go back the previous page without store the changes when the first letter of the file title is highlighted.

Notes:

- If the last letter of the file name is Space(SP) character, the file name does not include the last letter.
- If number of letter is more than 60, last letter is deleted when a new letter is added.

4) Delete

The “Delete” menu item allows you to delete the selected file.

1. In the file list menu, press the **PITCH +** or **PITCH –** button to select “Delete”. Then press the **▶/||/ENTER** button.
 - “File Delete?” appears on the display.
 - Select “Yes” and press the **▶/||/ENTER** button to delete the file.
 - Select “No” and press the **▶/||/ENTER** button to return to File List Menu.
 - Press the **STOP** button to return to the stop mode.

5) Copy

The “Copy” menu item allows you to make a copy of a file from the current folder to another folder.

1. In the file list menu, press the **PITCH +** or **PITCH –** button to select “Copy”. Then press the **▶/||/ENTER** button.
 - The folder list appears on the display.
2. Press the **PITCH +** or **PITCH –** button to select the folder you wish to copy to. Then press the **▶/||/ENTER** button.
 - The copy starts. “Executing...” appear during copy process.
 - Press the **STOP** button to return to the stop mode.

6) Move

The “Move” menu item allows you to move a file from the current folder to another folder.

1. In the file list menu, press the **PITCH +** or **PITCH –** button to select “Move”. Then press the **▶/||/ENTER** button.
 - The folder list appears on the display.
2. Press the **PITCH +** or **PITCH –** button to select the folder you wish to move to. Then press the **▶/||/ENTER** button.
 - The move starts. “Executing...” appear during moving.
 - Press the **STOP** button to return to the stop mode.

7) Delete Marks

The “Delete Marks” menu item allows you to delete all marks in the selected file.

1. In the file list menu, press the **PITCH +** or **PITCH –** button to select “Delete Marks”. Then press the **▶/||/ENTER** button.
 - “MARK Delete?” message appears on the display.
 - Select “Yes” and press the **▶/||/ENTER** button to delete marks.
 - Select “No” and press the **▶/||/ENTER** button to return to the File List Menu.
 - Press the **STOP** button to return to the stop mode.

Folder List Menu

The folder list menu item allows you to display a list of folder titles. And you can set the selected folder as a current directory, change the folder title, delete the folder and create a new folder.

1. While the file list is displayed in the “LIST” status, press the **◀◀** button.



- The folder list appears on the display.
- The selected item is highlighted.
- When the first item is selected, press the **PITCH +** button to jump to the last item.
- When the last item is selected, press the **PITCH –** button to jump to the first item.

2. Press the **PITCH +** or **PITCH –** button to select the folder you want to access. Then press the **▶/||/ENTER** button or the **⏏ (F1: MENU)** button to enter the Folder list Menu.

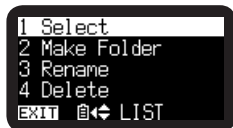

- Press the **⏏ (F1: EXIT)** button to return to the Folder list.
 - During Folder list Menu mode, press the **STOP** button to return to the stop mode.
3. Press the **PITCH +** or **PITCH –** button to select the item to access. Then press the **▶/||/ENTER** button to jump to the item or execute.

Folder list Menu Functions

#	Display	Description
1	Select	Set the selected folder as the current folder.
2	Make Folder	Create a new folder.
3	Rename	Change the selected folder title.
4	Delete	Delete the selected folder.

1) Select

The “Select” menu item allows you to set the selected folder as the current folder.

1. In the folder list menu, press the **PITCH +** or **PITCH –** button to choose “Select”.



2. Press the **▶/||/ENTER** button to set the selected folder to the current folder.

2) Make Folder

The “Make Folder” menu item allows you to create a new folder.

1. In the folder list menu, press the **PITCH +** or **PITCH –** button to select “Make Folder”. Then press the **▶/||/ENTER** button.
 - A new folder titled “NewFolder” is created.
 - The folder list appears and the new folder is highlighted.

Notes:

- If the “NewFolder” already exists, “Already Exists” message appears for one second.
- If the number of folders is already 32, “Full Folder” message appears for one second.

3) Rename

1. In the folder list menu, press the **PITCH +** or **PITCH –** button to select “Rename”.
2. Press the **▶/||/ENTER** button to access the rename window.
3. Rename the file title.
Refer to the procedure of the “Preset Rename” (👉 P. 43).
4. Press the **▶/||/ENTER** button to return to the folder list menu.
Press the **◀◀** button to go back to the previous page without store the changes when the first letter of the folder title is highlighted.

Notes:

- If the Last letter of the folder name is Space(SP) character, the folder name does not include the last letter.
- If the number of letter exceeds the limit of 32, last letter is deleted when a new letter is added.

4) Delete

The “Delete” menu item allows you to delete the selected folder.

1. In the folder list menu, press the **PITCH +** or **PITCH –** button to select “Delete”. Then press the **▶/||/ENTER** button.
 - “Delete?” message appears on the display.
 - Select “Yes” and press the **▶/||/ENTER** button to delete the folder.
 - Select “No” and press the **▶/||/ENTER** button to return to the folder list menu.
 - Press the **STOP** button to return to the stop mode.

Note:

You cannot delete the last folder remained in an SD card. When the last folder remains, “Can not...” appears for one second.

Troubleshooting

Should problems occur, it is often unnecessary to consult your dealer or technical service department. On the basis of the following checks, you may be able to rectify a number of conditions yourself without difficulty. If the condition cannot be remedied after the following check, please consult your dealer or service centers. Service centers are listed at <http://www.d-mpro.com>.

The PMD661MKII does not turn on.

- Install fresh batteries.
- Check AC adapter connections.

The PMD661MKII turns on then turns itself off.

- Install fresh batteries.

The PMD661MKII seems to record, but there is no sound on playback.

- Check input settings.
(For example, if LINE input is selected and no input is connected to the LINE jack, the PMD661MKII will record silence. The PMD661MKII will not playback.)

There is no audio playback through headphones or internal speaker.

- Check VOL+/- control setting.
- Check a different audio file or the card.

The PMD661MKII will not record.

- Check that the maximum of 999 files have not been recorded.
- Check that the PMD661MKII acknowledges the card.

No signal from microphone input.

- Check input selection.
- Check REC LEVEL control settings.
- Check if microphone(s) require(s) Phantom power.

There is excessive noise on the PMD661MKII.

- Check cable connections and/or replace cable.
- Check for proper gain levels.

Playback on a PC results in poor sound.

- Check quality of PC sound card and program.
- Check frequency conversion program.*

* The PMD661MKII records audio files with a sampling frequency of 48kHz. Some PC programs convert the files to 44.1kHz (using a sample rate converter). Only high quality sample rate converters should be used.

PC cannot read files

- Check the capability of the PC program. Some playback and editing programs do not support MP3 or Broadcast Wave (.wav) formats.
- Use DMP Mark Editor to play files recorded with encrypted recording on a computer.

If the PMD661MKII exhibits erratic behavior, the microprocessor can be reset by powering off, disconnecting AC power and removing batteries.

Care and Maintenance

Use a soft cloth slightly moistened with mild detergent solution. Media cards that are heavily used should be occasionally reformatted to avoid audio problems due to fragmentation.

Error Message

Details of error processing

Display	Description
No Card	Card cannot be found
Unformat	Format other than FAT16/32, or card format error
Full Card	Memory is not enough
Full 999	Number of files is already 999 (maximum)
Full MARK	Number of marks in the current file is already 30 (maximum)
No File	No file found
Key Locked	Operation during Key Lock
Card Locked	Prohibition of writing into the card
VBR	FWD or RWD of VBR file
Can not...	Command is invalid
Need DC IN	No DC input
Low Battery (flashing highlighted)	Remaining battery is below set value
Low Battery	Automatic power down in low battery level last time.
No PresetFile	No preset setting file is found
ErrPresetFile	File contents of preset setting has errors
ErrUpdateFile	Version up file or file system does not function normally
Door Open	SD card door is open
Err Format	Error in file format of MP3 or PCM
Already Exists	Same file title is found
Limit 80m	Over 80 minutes in copy segment process
Long Title	File title exceeds 64 Bytes
Err Card	Error is found in the card
Err RTC	Error is found in RTC
Err SRAM	Error is found in SRAM
Err FlashROM	Error is found in Flash ROM
Need Update	Update is not completed
Unmatched	Setting of the preset is not correct
Passcode Fail	Passcode when playing WAS or MPS files is incorrect, or passcode when unlocking the "Menu Lock" is incorrect.

Factory Default

Perform the procedure below to restore the menu settings, passcode, etc., to their factory defaults.

- 1.** Press the **DISPLAY** button and **REC PAUSE** button at the same time, and turn the **POWER slide** switch ON. At this time, the service menu list is displayed in the display section.
- 2.** Press the **PITCH +** or **PITCH –** buttons to select “Factory Default?”. At this time, the selected menu item is highlighted.
- 3.** If the **▶/II/ENTER** button is pressed “Default?” is displayed in the display section.
- 4.** While “Default?” is being displayed, press the **I◀◀** button and select “YES”.
- 5.** If the **▶/II/ENTER** button is pressed “Executing ...” flashes in the display section.
 - When the settings have returned to the factory default settings, “Completed” is displayed for 1 second, after which the display section returns to the service menu.
 - When the settings have been returned to the factory default settings, the “Date Form” default setting is the setting for the US. This needs to be set correctly for the destination.
“Date Form”
US : M/D/Y
Europe : D/M/Y
- 6.** Turn the **POWER slide** switch OFF.

Specifications

Digital Audio System

System	Solid State Recorder
Usable media.....	SD/SDHC cards
Recording format	
MP3.....	MPEG1 Layer III Compression
WAV.....	16/24 bit linear PCM
Recording MP3 bit-rate.....	320/256/192/128/64 kbps
Sample rate.....	44.1/48/96 kHz
Number of channels.....	2 (Stereo)/1 (Mono)

Audio Performance

Frequency response.....	20 Hz - 24 kHz (\pm 1dB)
S/N ratio IEC-A weighted	
MIC	65 dB
LINE.....	85 dB
Total harmonic distortion at 0 VU	
MIC	0.08%
LINE.....	0.02%
Dynamic range.....	85 dB

Inputs

External MIC	
Type	XLR stereo jack
Input sensitivity	1.2 mVrms/4.2 kohms
LINE	
Type	XLR stereo jack
Input sensitivity	0 dBu/4.2 kohms
LINE2	
Type	1/8" stereo jack
Input sensitivity	500 mVrms/20 kohms

Outputs

LINE	
Type	RCA stereo jack
Standard level.....	2.0 V/10 kohms
Headphone	
Type	1/4" stereo jack
Standard level.....	16 mW/32 ohms
Speaker	
Standard level.....	450 mW/8 ohms

General

Power consumption	
Recording/Playback	4.2 W (DC)
Battery life (Alkaline).....	.5 hours (Typical)
Phantom power.....	48V, 10mA (Max.)
Power	
AC adaptor	DA620PMD included
Batteries.....	4 x AA type alkaline dry cell batteries or 4 x AA type Ni-MH rechargeable batteries
Backup battery	Lithium battery for real-time clock
Environmental conditions	
Operational temperature.....	0 - 40°C (32 - 104°F)
Operational humidity.....	25 - 85% (no condensation)
Storage temperature.....	-20 - 60°C (-4 - 140°F)
Dimensions	
Width.....	93 mm (3.7")
Height	165 mm (6.5")
Depth	36 mm (1.4")
Weight (Excl. batteries).....	410 g (14 oz)

Included Accessories

Audio cable (RCA – 1/8" stereo type)
USB cable (Type mini-B – Type A)
AC adapter (DA620PMD)
User guide
CD-ROM
Carry strap
SD card

- Specifications are subject to change without notice.

Limited Warranty

Your Marantz Professional product is warranted against manufacturer defects in material and workmanship for a period of one year parts and labor.

Except as specified below, this warranty covers defects in material and workmanship. The following are not covered under warranty:

1. Damage, deterioration, malfunction or failure to meet performance specifications resulting from:
 - a) Accidents, acts of nature, misuse, abuse, neglect or unauthorized product modification.
 - b) Improper installation, removal or maintenance, or failure to follow supplied instructions.
 - c) Repair or attempted repair by a non-Marantz authorized agent.
 - d) Any shipment (claims must be presented to the carrier).
 - e) Any cause other than a defect of manufacturing.
2. Cleaning, check-ups with no fault found or changes incurred for installation, removal or reinstallation of the product.
3. Any serialized product on which the serial number has been defaced, modified or removed.
4. Batteries and battery chargers.
5. Accessories, including but not limited to: cables, mounting hardware and brackets, cleaning accessories, power cords and adapters, and carry cases.

Non-transferable warranty

This Warranty may be enforced only by the original purchaser.

What We Will Pay For

We will pay for all labor and material expenses for items covered by the warranty.

How You Can Get Service (Americas only)

1. If your unit needs service in the USA, contact our service referral at the appropriate telephone number indicated below. We will advise you of the name and location of one or more authorized service centers from which service may be obtained. Please do not return the unit directly to us.
2. You must pay any shipping charges if it is necessary to ship the product for service. If the necessary repairs are covered by the warranty, we will pay return shipping charges to your location anywhere in the United States or its territories.
3. Whenever warranty service is required, you must present the original dated sales receipt or other proof of date purchased.

Limitation of Implied Warranties

All implied warranties, including warranties of merchantability and fitness for a particular purpose, are limited in duration to the length of this warranty.

Exclusion of Damages (Americas only)

Liability for any defective product is limited to repair or replacement of the product at manufacturer's option. Manufacturer shall not be liable for damage to other products caused by any defects in Marantz products, damages based on inconvenience or loss of use of the product, or any other damages, whether incidental, consequential, or otherwise.

Some States do not allow limitations on how long an implied warranty lasts and/or do not allow the exclusion or limitation of incidental or consequential damages, so the above limitations and exclusions may not apply to you.

How State Law Relates to the Warranty (Americas only)

This warranty gives you specific legal rights, and you may have other rights which may vary from State to State.

Marantz Professional Service Number (Americas only):

Marantz Professional Factory Service (630) 741-0330

Products purchased outside of the United States, its possessions or territories.

This warranty is enforceable only in the United States and its possessions or territories.

Marantz Professional products Sales Office Site:

For inquiries or information on repair service of Marantz Professional Products, please contact our Sales Office or Tech Support Centre near you which are listed in D&M Professional website below.

AMERICA

D&M Professional America <http://usa.d-mpro.com>

EUROPE

D&M Professional Europe <http://www.dm-pro.eu>

ASIA/OTHERS

D&M Professional Asia <http://apac.d-mpro.com/eng>

D&M Holdings Inc.

TOKYO, JAPAN
www.d-mpro.com