

AKAI
professional

MINIAK
VIRTUAL ANALOG SYNTHESIZER

▶ REFERENCE MANUAL
ENGLISH (1 – 55)

WWW.AKAIPRO.COM

TABLE OF CONTENTS

BOX CONTENTS	2
CHAPTER 1: CONNECTIONS	2
CHAPTER 2: FIRST SESSION	3
A TOUR OF THE MINIAK	3
THE MINIAK'S TOP PANEL	3
KEY CONCEPTS	4
PLAY THE PROGRAMS	4
SWITCH OCTAVES.....	5
EXPLORE THE BUILT-IN SEQUENCES.....	5
EXPLORE THE RHYTHMS	6
EXPLORE THE MULTIS	6
RECORD SOME PHRASES.....	7
CONNECT EXTERNAL INSTRUMENTS	7
CHAPTER 3: SEQUENCES	8
PLAYING SEQUENCES.....	8
SEQUENCE TYPES: ARPEGGIOS & SEQUENCES.....	8
EDITING SEQUENCES	9
CHAPTER 4: RHYTHMS	14
PLAYING RHYTHMS.....	14
EDITING RHYTHMS.....	14
CHAPTER 5: MULTIS	19
PLAYING MULTIS.....	19
MULTI COMPONENTS.....	19
EDITING MULTIS	19
CHAPTER 6: PROGRAMS	26
WHAT IS A PROGRAM?	26
HOW THE MINIAK MAKES SOUND	26
MODULATION	27
PLAYING PROGRAMS	28
EDITING PROGRAMS.....	28
CHAPTER 7: CONFIGURATION	47
[CONFIG].....	47
CONFIGURATION PARAMETERS.....	47
CHAPTER 8: MIDI	49
WHAT IS MIDI?	49
FREQUENTLY ASKED QUESTIONS	51
TROUBLESHOOTING	53
TECHNICAL SPECIFICATIONS	55

BOX CONTENTS

- MINIAK
- Gooseneck microphone
- Power adapter
- Quickstart Guide
- Reference Manual
- Safety Instructions & Warranty Information Booklet

For more effective service and product update notices, please register your MINIAK online at <http://www.akaipro.com>

CHAPTER 1: CONNECTIONS

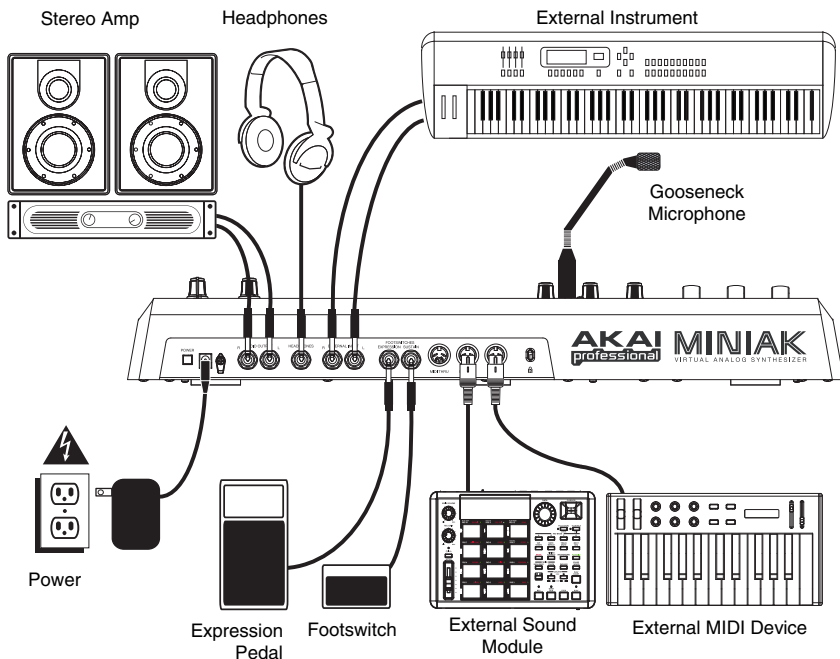

CONNECTING AC POWER

Before making any power connections, make sure the MINIAK's power switch is turned off. Then, plug the power adapter into the MINIAK's power input and into a power outlet.

MAKING AUDIO CONNECTIONS

STEREO: Connect two cables from the MINIAK's left and right outputs to two inputs of an amp or mixer.

HEADPHONES: Plug a set of headphones into the headphone jack on the rear panel.

CONNECTING THE FOOT PEDALS

Connect a keyboard sustain pedal (not included) to the (SUSTAIN) input. When you turn the MINIAK on, the MINIAK will automatically sense and calibrate itself to the pedal.

You can plug an optional continuous controller expression pedal into the (EXPRESSION) input.

WARNING: When connecting audio cables or turning power on and off, make sure that the amplifiers in your system are turned off or the volume controls are turned down. If you don't do this, you can create loud bursts of sound that might damage your speakers.

NOTE: If your sustain pedal response is backward (i.e., notes sustain when your foot is off the pedal), turn off your MINIAK and make sure the footswitch plug is fully inserted into the (SUSTAIN) jack. Then, turn the MINIAK back on while keeping your foot off the footswitch.

CHAPTER 2: FIRST SESSION

A TOUR OF THE MINI AK

In this session, we'll:

- Explore the MINI AK's top panel
- Define some key concepts
- Play some of the MINI AK's basic sounds (called Programs)
- Learn different ways to navigate the MINI AK's Programs
- Explore the built-in Sequences
- Capture and play back some phrases
- Explore the MINI AK's drum sounds and play some Rhythms
- Explore the MINI AK's Multi setting (where Programs, Sequences, Rhythms, and more all come together in powerful, flexible combinations)

THE MINI AK'S TOP PANEL

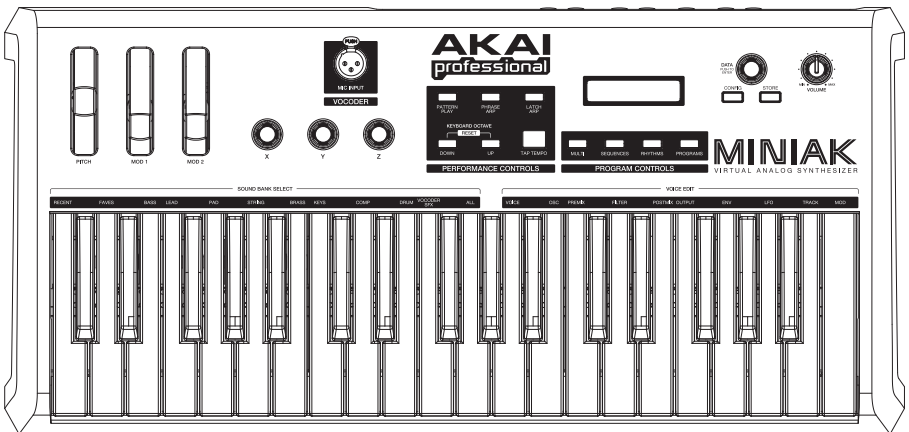

VOLUME

The (**VOLUME**) knob on the far right-hand side of the MINI AK raises and lowers the volume. If you don't hear anything as you play the MINI AK, check the (**VOLUME**) knob's setting.

REAL-TIME CONTROLLERS

The (**MOD1**) and (**MOD2**) wheels, (**PITCH**) wheel, and (**X/Y/Z knobs**), located on the left half of the MINI AK, provide real-time control of the MINI AK's sounds.

PERFORMANCE BUTTONS

The [**OCTAVE**], [**TAP TEMPO**], [**PHRASE ARP**], [**LATCH ARP**], and [**PATTERN PLAY**] buttons switch octaves, set the tempo, and execute other performance-related functions.

DISPLAY

Information relevant to the current operation is shown on the LCD.

PROGRAM & DATA CONTROLS

These are the MINI AK's most important controls – the **DATA DIAL** and the [**PROGRAMS**], [**MULTI**], [**SEQUENCES**], [**RHYTHMS**] and [**CONFIG**] buttons. They control the MINI AK's primary modes of operation. Turning the **DATA DIAL** cycles through options, and pushing it allows you to edit these options.

KEY CONCEPTS

Here are the MINIAK's most important concepts:

PROGRAMS

Programs are the MINIAK's sounds, built from its oscillators, envelopes, filters, modulation matrix, and other analog-style components.

SEQUENCES

Sequences are repeating melodic and/or rhythmic motifs. There are two types of Sequences — arpeggios and sequences. (See Chapter 3 for more information.)

RHYTHMS

Rhythms are combinations of sequenced drum programs. Think of a drum machine with its interchangeable sounds and sequences.

MULTI

The Multi setting combines multiple Programs, Rhythms, Sequences, and more. This is the MINIAK's most powerful and most sonically sophisticated element.

NAVIGATING WITH THE DATA DIAL AND ITS BUTTONS

Use the **DATA DIAL** to the right of the display the performance controls to navigate through the MINIAK's options. Most MINIAK functions involve pressing the buttons and then turning or pushing this knob.

"YELLOW LIGHT / RED LIGHT"

The [**PROGRAMS**], [**SEQUENCES**], [**RHYTHMS**], and [**MULTI**] buttons glow yellow when first pressed indicating that you're in "Play Mode," and the **DATA DIAL** can be used for selecting. When the **DATA DIAL** is pushed, the buttons glow red, indicating that you are in "Edit Mode" and that the **DATA DIAL** can be used for editing.

At any one time, only one of the buttons will glow, indicating that the MINIAK is operating within that mode.

"TURN"

Turn the **DATA DIAL** to cycle through various options.

"PUSH"

Push the **DATA DIAL** to edit the option displayed. Push again to stop editing. See the following visual illustration:

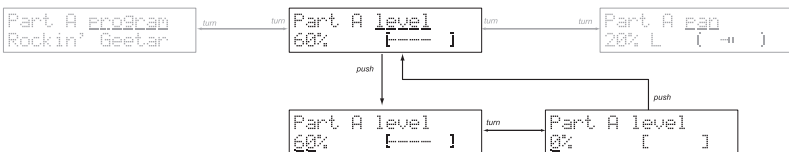

PLAY THE PROGRAMS

The MINIAK's basic sounds are called "Programs." Try playing some of these Programs now.

Find the [**PROGRAMS**] button on the right side of the top panel. Press it; then spin the **DATA DIAL**. Notice how the Programs are organized by category – basses, then leads, then pads, etc.

Turn the volume up and listen to some of these Programs. Experiment with the (**PITCH**), (**MOD1**), and (**MOD2**) wheels and the (**X/Y/Z knobs**). Here are a few points to note:

- The (**X/Y/Z knobs**) do different things depending on the Program. Sometimes, they increase or decrease the quickness of the attack. Sometimes, they change the tone by adjusting the filter resonance.
- The (**MOD1**) wheel typically – but not always – adds vibrato.
- The (**MOD2**) wheel typically – but not always – sweeps the filter frequency, radically changing the tone.

Play some notes before, during, and after moving the **(MOD2)** wheel. You'll most likely hear the classic analog synthesizer "filter sweep" sound.

USE THE VOCODER

Connect the gooseneck microphone (included) to the **(MIC INPUT)** on the MINIAK. Hold down **[PROGRAMS]** then press the VOCODER / SFX key on the keyboard. Use the **DATA DIAL** to scroll through the Programs shown in the LCD. Vocoder Programs are denoted by a "#" symbol. Select one, hold down different combinations of keys on the keyboard, and talk into the mic!

NAVIGATE THROUGH THE PROGRAMS

If you rotate the **DATA DIAL** enough, you'll pass through 13 categories of Programs. At the end of the list, all of the Programs are presented alphabetically, regardless of category.

*To jump to a category instantly, hold down **[PROGRAMS]** and then press the associated white key.*

Notice the text just above the keyboard. This text corresponds to the 13 categories and also includes the all, uncategorized listing. To jump to a category instantly, hold down **[PROGRAMS]** and then press the associated white key.

SPECIAL CATEGORIES

All: As we've already seen, the *all* category is an alphabetical listing of all the Programs.

Recent: The ten most recently played Programs are stored for you automatically under the *recent* category. They are still listed under their primary categories. This is a duplicate listing to allow for fast access. Note that you cannot directly edit this listing. You need to select and then play the Programs you want to be listed here.

Faves:

Adding Programs to Faves: When you find a Program you particularly like, add it to the Faves ("Favorites") category. In **[PROGRAMS]** mode, press the **DATA DIAL** to enter edit mode. You will be asked to *Add to faves?* Press the **DATA DIAL** once again to add the Program to the Faves category. There is no limit to the number of faves you can have. Press the **[PROGRAMS]** button again if you want to cancel this action and exit the editing screens.

Removing Programs from Faves: To remove a Program from the Favorites list, call up the Program and press the **DATA DIAL**. You will be asked, "Remove fave?" Press the **DATA DIAL** to perform the action.

SWITCH OCTAVES

While the MINIAK is a compact unit, all of its sounds span the full 128-note MIDI range. Use the **[OCTAVE]** buttons to the left of the display to transpose the keyboard up and down to cover that range.

Notice how one or the other **[OCTAVE]** lights glows progressively brighter as you push it. This provides a visual indication of the current octave setting.

Press both **[OCTAVE]** buttons simultaneously to return to the default octave setting.

EXPLORE THE BUILT-IN SEQUENCES

The MINIAK features a powerful pattern sequencer with lots of editing capabilities. To play some Sequences, press the **[SEQUENCES]** button to the left of the display. Turn the **DATA DIAL** to cycle through various preset Sequences. Play the keyboard to hear them.

[TAP TEMPO]

Tap the **[TAP TEMPO]** button to the left of the display. Watch and hear how **[TAP TEMPO]** controls the tempo. Note that the Sequence's tempo immediately locks to the speed at which you tap.

To adjust the tempo with finer control (one-tenth of a beat per minute), hold down the **[TAP TEMPO]** button and turn the **DATA DIAL** left or right to slow down or speed up. The display will indicate the current tempo.

[LATCH ARP]

Press the **[LATCH ARP]** button, also to the left of the display. Remove your hands from the keyboard. The Sequence keeps playing.

Press **[LATCH ARP]** again to stop the Sequence from playing.

EXPLORE THE RHYTHMS

Rhythms combine drum/percussion programs with specifically designed rhythm patterns. Press **[RHYTHMS]**. Turn the **DATA DIAL** to cycle through different Rhythms.

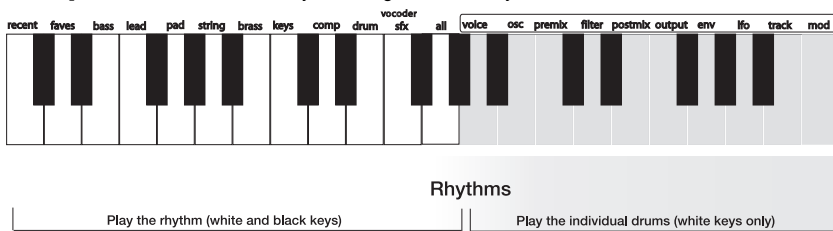

TO PLAY A RHYTHM

Press and hold any key from the bottom of the keyboard up to the middle G#. (These are the keys labeled from *recent* through *all*.)

TO PLAY A RHYTHM'S INDIVIDUAL DRUM SOUND

Press one of the white keys from middle A (labeled *voice*) upward. The keyboard's middle A corresponds to the rhythm's Drum A. The next higher note, B (labeled *osc*), corresponds to Drum B. Proceeding higher, drums C, D, E, etc. are triggered. Any keys higher than the rhythm's highest note will do nothing.

TO PLAY A RHYTHM HANDS FREE

Press any key from middle G# down on the keyboard. While holding down that key, press **[LATCH ARP]** to keep the rhythm going. Press **[LATCH ARP]** a second time to stop the rhythm.

TO CHANGE THE TEMPO

Tap the **[TAP TEMPO]** button a few times, or hold down **[TAP TEMPO]** and turn the **DATA DIAL**.

Each Rhythm's drum sounds, relative sound levels, left/right panning, rhythmic patterns, time signature, duration, quantization, and name can be edited.

EXPLORE THE MULTIS

Press **[MULTI]** to explore this mode. Multi combines the following elements:

- Multiple Programs
- Multiple Sequences
- Multiple Rhythms
- Splits (like placing a rhythm on the left side of the keyboard, a bass program in the middle, and a lead program on the right)
- Latch on/off settings
- Semitone transpositions
- Level and left/right panning
- Effects settings
- Controller assignments

First, simply press the **[MULTI]** button, twirl the **DATA DIAL** a few times, and listen to the various presets. Be sure to play throughout the keyboard range to experience the various splits, layers, and rhythm triggers. These presets will give you a good sense for some of the different possibilities you can create on your own.

The MINIAK was designed to make it easy to compose and modify your own Multis. Try creating your own Multi with these steps:

1. Go into Programs and find a bass sound you like.
2. Push the **DATA DIAL** and select "start new Multi"
3. Now go back to Programs and find a lead instrument you like.
4. Push the **DATA DIAL** and choose "add to Multi?" Then select "Split A high?"
5. Now go into the "Rhythms" section and find a rhythm you like.
6. Now hold down the **[RHYTHMS]** button and push the **[MULTI]** button. This adds the beat to your Multi.
7. Start jamming.

RECORD SOME PHRASES

You don't have to be in Sequences Mode to create a Sequence. At any time, the MINIAK can capture your playing and use it as a Sequence. The Sequences that you capture in real time are called "phrases."

PHRASES WITHIN PROGRAMS MODE

Press **[PROGRAMS]** to enter Programs Mode. Hold down the **[PHRASE ARP]** button and start playing a riff. As soon as you hit the first note, the **[PHRASE ARP]** button will start flashing, indicating that it is recording what you play. You can release the **[PHRASE ARP]** button any time after you've played that first note.

If you cannot store because storage protection is on, see Chapter 7 ("Store Protect") for more information.

When you are done playing the phrase, press the **[PHRASE ARP]** button again. The button will light, indicating that the MINIAK is ready to play your phrase back. Press any key, and you'll hear your phrase loop to the tempo.

The last phrase you have recorded is stored as a Sequence named "*" Phrase", which appears near the beginning of the Sequences list. If you record a phrase that you really like and want to keep, simply find the "*" Phrase" Sequence and give it a new name.

PHRASES WITHIN MULTI MODE

Phrases are most useful in Multi Mode because you can use a Rhythm or Sequence to keep time as you play.

Phrases get a little more complicated in Multi Mode, since each part can have its own phrase. But the basic idea is the same – hold down the **[PHRASE ARP]** button and start playing. Whatever parts you play on will get their own phrases.

To record a phrase and clear all of the other phrases, hold down **[PHRASE ARP]** and start recording when the button is unlit. To add the phrase to the existing phrases, start recording when the button is already lit.

The latest phrases you have recorded in Multi Mode are stored as Sequences "*" Phrase PartA", "*" Phrase PartB", etc. Again, rename the phrase Sequences that you want to keep.

Try recording a phrase for yourself. Go to the "Bass/LeadSplit" preset under the Multi menu and record bass and lead phrases. The lower half of the keyboard plays the bass and upper keys play the lead. Then play back your phrases by hitting any note on the keyboard.

How Phrases are associated to Parts

The first note you play in a phrase determines the part with which the phrase will be associated.

For example, consider a bass/lead split Multi with the bass (Part A) on the lower half of the keyboard and the lead (Part B) on the upper half.

If you begin your phrase low on the keyboard – even if you eventually play some high keys – the phrase created will be associated with Part A.

If you begin your phrase high on the keyboard – even if you eventually play some low keys – the phrase created will be associated with Part B.

What if your Multi plays more than one Program when you press the first note in your phrase? In that case, the phrase will be associated to the lowest-lettered program that uses that first note.

CONNECT EXTERNAL INSTRUMENTS

You can connect external audio sources – other synthesizers, mixers, guitars, etc. – using the 1/4-inch **(AUDIO IN)** jacks on the back of the MINIAK. The jacks accept either balanced or unbalanced cables.

See Chapter 6 to learn about the MINIAK's filter parameters.

Your external audio can be blended in with the MINIAK's internal sound-producing oscillators. The resulting combination is then sent through the MINIAK's filters and effects. This doesn't happen automatically, though. You need to adjust some program parameters to send external audio into the mix. See Chapter 6 for more about these filters and effects.

Note: *The microphone will be bypassed when the left audio input is being used.*

Use both jacks for stereo input. Use the left **(AUDIO IN)** jack for mono-only sources (in which case the input will be sent to both the left and right channels).

A special group of programs – including vocoder programs – exists just for use with the external inputs. These programs begin with "#" and are accessible at the beginning of the vocoder/sfx Program category.

CHAPTER 3: SEQUENCES

PLAYING SEQUENCES

Sequences are repeated melodic figures that you trigger from the keyboard.

Press **[SEQUENCES]** near the **DATA DIAL**. To cycle through different Sequences, turn the **DATA DIAL**. The Sequence will change, with the current Sequence name shown in the display.

Press a key to play a Sequence. The Sequence continues playing as long as you hold down the key.

Using [LATCH ARP]

Press **[LATCH ARP]** to let the Sequence continue playing after you release the key.

Press **[LATCH ARP]** again to stop the Sequence from playing.

Using [TAP TEMPO]

Tap the **[TAP TEMPO]** button to increase or decrease the speed of the Sequence. To adjust the tempo with finer control, hold down **[TAP TEMPO]** and turn the **DATA DIAL**. The display will indicate the precise tempo.

SEQUENCE TYPES: ARPEGGIOS & SEQUENCES

A Sequence can be set to one of two types: "arpeggio" or "sequence".

Arpeggios and sequences both respond to a key press by playing a series of notes over a programmed rhythmic pattern. The difference lies in which notes they play.

An arpeggio loops over whatever notes you are holding down on the keyboard. If you hold down a chord, the MINIAK will generate a melody by playing each note of your chord individually.

A sequence, on the other hand, already has a melody line built in. So, all you have to do is hold down a single key, and the MINIAK will play back that melody relative to that key. Pressing another key will transpose the sequence.

A Sequence can easily be switched from an arpeggio to a sequence, and vice-versa. The underlying rhythmic pattern is kept the same—all that changes is whether the Sequence plays the notes you hold down or the notes it was recorded with.

If the distinction is unclear, choose your favorite Sequence, toggle its "type" parameter between "arpeggio" and "sequence" (see page 24), and try playing it both ways.

Phrases versus Sequences

In Programs and Multi modes, the [PHRASE ARP] button lets you quickly record and repeat a riff or melody line. Phrases are designed to be used "live", when inspiration strikes as you're playing.

*A phrase is nothing more than a Sequence that was recorded using the [PHRASE ARP] button. In fact, the most recently recorded phrase is stored as a Sequence named "** Phrase". If you happen to record a phrase that you really like and want to hang on to, simply find the "** Phrase" Sequence and give it a new name.*

SEQUENCE OPTIONS

Revert → stored?
(Bobbetty)

Send to Multi?...
→ Bass/LeadSplit

Start new Multi?
→ +Bobbetty

Sequence program
JacoInTheBox

Sequence length
1 bar

Sequence grid
16 steps/bar

Sequence type
arpeggio

Arpeggio span
±/1 octave

Arpeggio order
octave down

Record Sequence?
<Push or Play...>

1:1:0 (A+1) ■
#####

Clear controls?
(Bobbetty)

Clear Sequence?
(Bobbetty)

Sequence name: 1
[Bobbetty]

Send MIDI sysex?
(Bobbetty)

Send syx bundle?
(Bobbetty)

Store as copy?
(67% free space)

Delete Sequence?
(Bobbetty)

EDITING SEQUENCES

Choose an existing Sequence to edit by pressing the **[SEQUENCES]** button and turning the **DATA DIAL**. Hold down any key to play the Sequence. (Use the **[TAP TEMPO]** button to change the tempo.)

Once you've found a Sequence you want to edit, press the **DATA DIAL** to enter edit mode. Turn the **DATA DIAL** to cycle through the different options. Press the **DATA DIAL** to toggle in and out of editing the current parameter.

Here are the Sequence editing options:

1. Revert-to-stored? / Unrevert-to-edited?

If you have edited a Sequence, you may revert back to the original version. Press the **DATA DIAL** to revert. Go back to your edited state by press the **DATA DIAL** a second time to *unrevert*.

You can *revert* and *unrevert* to compare your changes with the original Sequence. When you're satisfied with your work, press **[STORE]** to save your changes.

2. Send to Multi?

Pressing the **DATA DIAL** at this option sends you to Multi Mode and allows you to make this Sequence a part of the last-selected Multi.

If the Multi does not have any parts, this Sequence is automatically assigned to the Multi's part A.

If the Multi already has one or more parts, you will be able to add the Sequence in one of the following ways:

1. **send to part**. The Multi's part will use this Sequence. Remember that a part uses both a Program and a Sequence. If the part's Program is set to "(Sequence's pgm)", then the Sequence will sound just as it does in Sequences mode. Otherwise, the Multi will play the Sequence using the part's own Program.

2. **layer**. The Multi's existing part is duplicated, resulting in a new part. The Sequence is then sent to the new part.

3. **split low**. The Multi's existing part is split in two at a particular key. The MINIAK prompts for a note on the keyboard at which to execute the split. The Sequence is then sent to the lower part of the split. Every note *below* the one you select will use this new Sequence. Every note *including and higher than* the note you select will use the Multi's existing part.

The new part is assigned the next letter after the split part. For example, if the Multi contains parts A, B, C, and D, and part B is the part that gets split, then part C will be the newly-added part. All later parts' letters are incremented by one.

To select the split point, turn the **DATA DIAL** or play a key. You can use the **[OCTAVE]** buttons if your desired split point is outside of the current key range.

4. **split high**. The Multi's existing part is split in two at a particular key. As with the *split low* option, the MINIAK prompts for a note on the keyboard at which to execute the split. The Sequence is then sent to the upper part of the split. Every note *above* the one you select will use this new Sequence. Every note *including and lower than* the note you select will use the Multi's existing part.

To select the split point, turn the **DATA DIAL** or play a key. You can use the **[OCTAVE]** buttons if your desired split point is outside of the current key range.

5. **add part**. The Sequence is added as a brand new part. All other part parameters are set to their default values.

Store your Sequence

The **[STORE]** button will light once you have edited a Sequence.

Press **[STORE]** after you're satisfied with your edits. Otherwise, your changes will be lost when you turn off your MINIAK.

Send to Multi only allows the option of sending the Sequence to the current Multi. Therefore, you may need to jump out of Sequence editing to choose a Multi before returning to Sequence and following this procedure.

How part letters change when "layer," "split low," and "split high" are used: When parts are layered or split high, the new part is assigned the next letter after the targeted part. All subsequent part letters are incremented by one.

For example, consider a Multi with four existent parts: A, B, C, D

If we split part B, the result is as follows: A, B (low split of B), C (high split of B), D (formerly "C"), E (formerly "D").

letters are incremented by one.

3. Start new Multi?

Pressing the **DATA DIAL** at this option creates a new Multi named with the Sequence's name and a "+" in front (e.g. "+Liner" and "+Bobbetty") and, if a Multi with this name already exists, a number at the end (e.g. "+Liner2" and "+Bobbetty2").

4. Sequence program

Choose the Program that the Sequence will use to play its notes. In order to quickly jump between program categories, you can hold down the **[SEQUENCES]** button and press the white keys labeled with category names.

Another way of setting the Sequence's Program is to bring it over from Programs Mode. Press **[PROGRAMS]** to enter Programs Mode, and find the Program that you want. Then, hold down **[PROGRAMS]** and press **[SEQUENCES]**, and the Sequence's Program will be set. This works in the other direction as well—hold down **[SEQUENCES]** and press **[PROGRAMS]** to bring the Sequence's Program over to Programs mode, perhaps for some quick editing.

5. Length

Select one of *1/4, 1/2, 1, 2* or *4* bars.

The Sequence will always play from the first note of the first bar. So, if you select a value shorter than the current one, the latter parts of the Sequence will be truncated. If you select a value longer than the current one and the latter part of the Sequence does not contain any notes, the new notes at the end of the Sequence will be empty.

6. Grid

Choose *8, 12, 14, 16, 20, 24,* or *32* steps per bar, or choose *unquantized*. Shortening the scale decreases the quantizing resolution. You're more likely to hear double notes and simpler syncopations at low values.

"Straight-ahead" feels tend to result from using *8, 16,* and *32* steps per bar. Swing and shuffle feels tend to result from choosing *12* or *24* steps per bar. But you can also create some different Sequences by using fractions of bars along with less obvious grid values, like *14* and *20*.

7. Type

Choose sequence or arpeggio. See "Sequence Types: Arpeggios & Sequences" above for more information.

8. Span (arpeggios only)

Choose a span ranging from *single note* – in which the note you press on the keyboard will be the only note that plays – to one that plays up, down, or up-and-down through *1, 2, 3,* or *4* octaves.

Length and Grid quantizing

The MINIAK records your playing at a very high resolution. The length and grid settings that you select for playing back your Sequences are used to non-destructively quantize those recordings.

So, if you record a four-bar Sequence and change its length later to 1/4 bar, the MINIAK will only play a fraction of your Sequence, but it will remember the whole thing. If you want to change the length back to four bars at any time, the complete Sequence will still be available.

Similarly, Sequence rhythms are quantized using the grid setting, but the underlying information remains untouched. So, as you cycle through different grid settings, you're likely to hear different syncopations and "feels" emerge.

Four Beats per Bar

All MINIAK Sequences have four beats per bar.

*You can still create odd-meter rhythms. It just takes a little calculation and a willingness to ignore the tempo indications given by the **[TAP TEMPO]** button.*

For instance, one way to create a 3/4 feel is to combine a length of 1/2 bar with a grid of 24 steps. That will give you a total of 12 steps to work with.

Ignore the display's "6 + 6" grouping. Think "4 + 4 + 4" instead.

9. Order (arpeggios only)

When you hold down more than one note, you can specify the order in which they will be arpeggiated:

- The order in which they were initially pressed (called as *played*).
- *Up*. The arpeggiator plays the notes you are holding from the bottom to the top. Once the top note is reached, the arpeggio begins from the bottom again.
- *Down*. The arpeggiator plays the notes you are holding from the top to the bottom. Once the bottom note is reached, the arpeggio begins from the top again.
- *Up+Down Incl*. This mixes the *up* and *down* settings, playing up the notes you are holding and repeating the top note and the bottom note. The *incl* stands for *inclusive*.
- *Up+Down Excl*. This mixes the *up* and *down* settings, playing up the notes you are holding without repeating the top note and the bottom note. The *excl* stands for *exclusive*.
- *Octave Jump*. The arpeggiator plays the notes you are holding but plays the first note in two or more octave registers before playing the second note, which it also plays in two or more octave registers, etc.
- *Random*. The arpeggiator plays the notes you are holding down in a random order.

10. Real-time recording

Once you've reached the "record" parameter, you'll hear the metronome start to click. Use this "lead-in" time to get yourself into the groove. (As always, if the tempo isn't right, you can use the [TAP TEMPO] button to adjust it.)

Once you're ready to play, just start playing. The MINIAK will begin recording from the first note of the Sequence. Alternately, if you don't want to play from the first note, you can push the **DATA DIAL** to kick off the recording.

The Sequence will loop continuously, so you can add to it each time it comes around. When recording in real-time, remember that playing will never erase anything you've already recorded. To wipe out a section so you can replay it, hold down the **DATA DIAL** as it gets played back.

To stop recording, turn the **DATA DIAL** or press a mode button.

You will often want to clear the entire Sequence and start over. One way of doing this is to hold down the **DATA DIAL** and wipe out the Sequence as you record. But a quicker way is to hold down the [SEQUENCES] button and hit the highest note on the keyboard. This is a shortcut to the "Clear Sequence?" option.

The MINIAK records not only the keys you play, but all movements of the (PITCH), (MOD1), and (MOD2) wheels. These controller movements don't even need to be recorded at the same time as the keys. A useful technique is to play the keys first, and then when the recording loops around, play on the controllers to add some life to your notes. If you do this, you will probably also be using the "Clear controllers?" option as well, so you can revise your controller movements until you're satisfied.

Arpeggios or Sequences?

Arpeggios contain Rhythm and velocity (relative volume) information.

Sequences contain not only Rhythm and velocity information but also pitch information.

Use arpeggios for computer-generated patterns.

Use sequences for melodies and basslines.

Octave Jump: *To hear Octave Jump in action, Span should not be set to "single note."*

Time display: *The MINIAK displays time as "bar:beat:tick". There are four beats in a bar, and 120 ticks in a beat.*

Three-step beats land on 0, 40, and 80.

Four-step beats land on 0, 30, 60, and 90.

Five-step beats land on 0, 24, 48, 72, and 96.

Changing the metronome

The metronome you hear when recording is, in fact, just another Sequence. It is named "Metronome", and appears near the beginning of the Sequence list. You are free to edit this Sequence all you like. For example, you can choose a different program, or put the clicks on eighth notes or triplets instead of quarter notes. A quick way of disabling the metronome entirely is to simply rename this Sequence and store it. You can always bring back the metronome later with another rename.

11. Step editing

Turn the **DATA DIAL** to cycle through each step. You can quickly jump to the first step of the Sequence by holding down the **[SEQUENCES]** button and pressing A above middle C (labeled "voice").

Every aspect of the Sequence is editable:

a. Adding and replacing notes and chords

Play one or more keys at any step to add (or replace) that step's entry. Pitch, velocity, and length will be recorded, as will any wheel moves you make while the keys are held down.

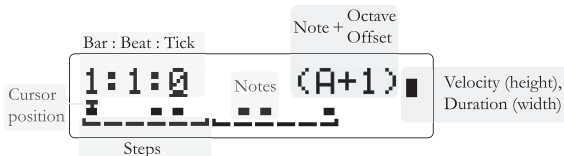

If the Sequence type is set to "arpeggio," the pitch will not actually be used when the Sequence is played back, since the MINIAK will play the Sequence over whatever notes you hold down. But if you later set the type to "sequence," your recorded pitches will reappear.

The cursor will automatically move on to the next step.

b. Removing notes

To remove a note, place the cursor under any step and double-click the **DATA DIAL**. The note, plus all controller movements between this note and the next one, will be removed.

c. Moving notes

To move a note, place the cursor under it. Then press and hold down the **DATA DIAL** and turn it to the left or right. Imagine that you are "dragging" the note.

d. Editing velocity

Place the cursor under the note that you want to edit and press the **DATA DIAL**. Turn the **DATA DIAL** to increase or decrease the velocity. You can remove the note by turning the velocity down to zero. While you're editing velocity, you can play any key to hear what the note sounds like at that velocity. (**Note:** Though the duration of the note is displayed in this screen, it cannot be edited here.)

e. Editing duration

To edit the duration of a note, move the cursor to it and play the note with the duration you desire. The duration value cannot be edited directly, but a rough indication of the duration can be seen on the upper right side of the display.

12. Clear controllers?

Press the **DATA DIAL** to erase all controller movements from the Sequence, but keep the notes. This is handy if you recorded some controller movements that you're unhappy with, and want to try another take without starting the Sequence from scratch.

13. Clear Sequence?

Press the **DATA DIAL** to erase all notes and controller movements from the Sequence, but keep the basic Sequence parameters. To quickly jump to this option, hold down the **[SEQUENCES]** button and press the highest note on the keyboard.

Controllers and step editing

Remember that controller movements are recorded while a note is held down. So, it is perfectly possible to record a pitch bend while step editing; just play the note and turn the pitch wheel.

Removing multiple notes

*To remove multiple notes at once, place the cursor at the right-most note you want to remove. Then hold down the **DATA DIAL** and turn it all the way to the left before releasing it.*

Gauging note velocity and duration on the display

As you place the cursor under each note, the top right side of the display will change.

Higher velocities are illustrated with higher bars.

Longer note lengths are illustrated with thicker bars. Notes can overlap one another, but that overlap is not visible on the display.

14. Sequence name

Since Sequences are listed alphabetically, creative naming can help you move smoothly from one Sequence to another.

Turn the **DATA DIAL** to select a position (1 – 14) to edit. Then press the **DATA DIAL** to edit that position. Edit either by turning the **DATA DIAL** or pressing notes on the keyboard.

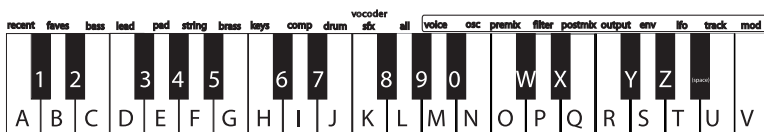

Press a key twice to toggle between upper and lower case.

Inserting and deleting characters: To insert a space in the name, navigate to the position at which you want to add the space. Hold down the Band turn it clockwise. To delete a character, navigate past it, hold down the **DATA DIAL**, and turn it counterclockwise. (In both cases, imagine that you are "dragging" the name around.)

15. Send MIDI sysex?

Choose this option to send the Sequence to a computer or other MIDI storage device using the MINIAK's (**MIDI OUT**) port.

This allows you to back up your Sequences to your computer, or share them with your friends or over the internet. (See Chapter 8 for details on what Sysex is and how to use it.)

16. Send syx bundle?

Choose this option to send both the Sequence and its program to a computer or other MIDI storage device using the MINIAK's (**MIDI OUT**) port.

17. Delete Sequence?

Delete the Sequence using this function, if desired. You will be prompted to confirm this action.

18. Store a copy?

Unlike many synths, the MINIAK does not have fixed "banks" of Programs, Sequences, etc., each with a predetermined number of storage locations. Instead, you may freely create and delete Sequences at any time, just as you would on a computer.

"Store a copy?" is how you create a new Sequence. This option creates a brand new copy of the current Sequence, differing only in name. Now, when you make changes and hit the [**STORE**] button, you will be storing to this new copy.

Whenever you want to start a new Sequence from scratch, you will have to find an existing Sequence to base it off of, and then store a copy. Don't forget to store a copy, or you might accidentally overwrite the original Sequence.

Store your changes!

Be sure to press the [**STORE**] button after you're satisfied with your changes. Otherwise, your changes will be lost when the MINIAK is turned off.

However, keep in mind that you don't lose any changes when you switch to other modes, so feel free to browse through Programs or Multis without storing your Sequence. Additionally, if you play a Multi that uses the current Sequence, you'll hear your edited version, even without storing. This is a great way of checking how your edits sound in the context of a Multi, without having to commit to them.

You can even play other Sequences without losing your edits. Just hit the [**SEQUENCES**] button and turn the **DATA DIAL**. You can always come back to your edited Sequence, just as you left it. The MINIAK doesn't discard your edits until you start editing a different Sequence. If you intentionally want to discard your edits and revert to the version you last stored, you can use the "Revert -> Stored?" option.

Exiting Sequence editing

You can exit Sequence editing at any time. Simply press any of the buttons encircling the **DATA DIAL**, including the [**SEQUENCES**] button a second time.

CHAPTER 4: RHYTHMS

PLAYING RHYTHMS

Press the **[RHYTHMS]** button next to the **DATA DIAL**.

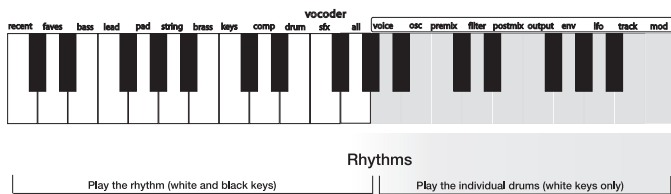

Press and hold any key on the left side of the keyboard to play a Rhythm.

Play the keys on the right side of the keyboard to play individual drum sounds. The keyboard's A above middle C (labeled *voice*) corresponds to the rhythm's Drum A. The next note, B (labeled *osc*), corresponds to Drum B, and so on.

Turn the **DATA DIAL** to play different Rhythms.

Using [TAP TEMPO]

Tap the **[TAP TEMPO]** button to increase or decrease the speed of the Sequence. To adjust the tempo with finer control, hold down **[TAP TEMPO]** and turn the **DATA DIAL**. The display will indicate the precise tempo.

EDITING RHYTHMS

First, choose an existing Rhythm to edit by pressing the **[RHYTHMS]** button and turning the **DATA DIAL**. Press any key on the left half of the keyboard to play the Rhythm. Use the **[TAP TEMPO]** button to change the tempo.

Once you've found a Rhythm you want to edit, press the **DATA DIAL** to enter edit mode. Turn the **DATA DIAL** to cycle through the parameters. Press it to edit a parameter; press again to exit parameter editing.

1. Revert-to-stored? / Unrevert-to-edited?

If you have edited a Rhythm, you may revert back to the original version. Press the **DATA DIAL** to *revert*.

Go back to your edited state by press the **DATA DIAL** a second time to *unrevert*.

Use *revert* and *unrevert* often in order to compare your changes to the original Rhythm. When you're satisfied with your work, press **[STORE]** to save your changes.

Store your Rhythm

The **[STORE]** button will light once you have edited a Rhythm.

Press **[STORE]** after you're satisfied with your edits. Otherwise, your changes will be lost when you turn off your **MINIAK**.

RHYTHM OPTIONS

Revert → stored?
(Thumpy)

Unrevert → edited?
(Thumpy)

Send to Multi?
→ Bass/LeadSplit

Start new Multi?
→ +Thumpy

Rhythm length
1 bar

Rhythm grid
16 steps/bar

Record rhythm?
(Thumpy)

Drum A recordcam
BD 909 Kick

Drum A level
99% [-----]

Drum A pad
44% L [---]

Drum A 1:1:0 |
[-----]

Drum A: Clear?
(BD 909 Kick)

Drum A: Remove?
(BD 909 Kick)

·
·
·

Drum E: Add?

Clear controls?
(Thumpy)

Clear rhythm?
(Thumpy)

Rhythm name: 1
[Thumpy]

Delete rhythm?
(Thumpy)

Send MIDI sysex?
(Thumpy)

Send syx bundle?
(Thumpy)

Store a copy?
(26% free space)

2. Send to Multi?

Pressing the **DATA DIAL** at this option sends you to Multi Mode and allows you to make this Rhythm a beat of the last-selected Multi.

If the Multi does not have any beats, this Rhythm is automatically assigned to the Multi's beat A.

If the Multi already has one or more beats, you will be able to add the rhythm in one of the following ways:

1. **send to beat.** The Multi's beat is replaced by the current Rhythm. The Multi beat's level, effects mix, key range, and latch status are retained.
2. **layer.** The Multi's existing beat is duplicated, resulting in a new beat. The Rhythm is then sent to the new beat.
3. **split low.** The Multi's existing beat is split in two at a particular key.

The MINIAK prompts for a note on the keyboard at which to execute the split. The Rhythm is then sent to the lower beat of the split. Every note *below* the one you select will use this new Rhythm. Every note *including and higher than* the note you select will use the Multi's existing beat.

The new beat is assigned the next letter after the split beat. For example, if the Multi contains beats A, B, C, and D, and beat B is the beat that gets split, then beat C will be the newly-added beat. All later beats' letters are incremented by one.

To select the split point, turn the **DATA DIAL** or play a key. You can use the **[OCTAVE]** buttons if your desired split point is outside of the current key range.

4. **split high.** The Multi's existing beat is split in two at a particular key.

As with the *split low* option, the MINIAK prompts for a note on the keyboard at which to execute the split. The Rhythm is then sent to the upper beat of the split. Every note *above* the one you select will use this new Rhythm. Every note *including and lower than* the note you select will use the Multi's existing beat.

3. Start new Multi?

Press the **DATA DIAL** to create a new Multi. The Multi will have one beat, using this Rhythm, but will otherwise be empty. You can then add parts and additional beats to the Multi, either by directly editing the Multi or via the "Send to Multi?" option in other modes.

The Multi's name will be the same as this Rhythm's, except preceded with a plus character. This ensures that the new Multi will appear near the beginning of the alphabetized Multis list. You can change the name later if you want to keep the Multi, or simply delete the Multi if not.

4. Length

Select one of 1/4, 1/2, 1, 2 or 4 bars.

The Rhythm will always play from the first note of the first bar. So, if you select a value shorter than the current one, the latter parts of the Rhythm will be truncated. If you select a value longer than the current one and the latter part of the Rhythm does not contain any notes, the new notes at the end of the Rhythm will be empty.

Send to Multi only allows the option of sending the Rhythm to the current Multi. Therefore, you may need to jump out of Rhythm editing to choose a Multi before returning to Rhythms and following this procedure.

How beat letters change when "layer," "split low," and "split high" are used: When beats are layered or split high, the new beat is assigned the next letter after the targeted beat. All subsequent beat letters are incremented by one.

For example, consider a Multi with four existent beats: A, B, C, D

If we split beat B, the result is as follows: A, B (low split of B), C (high split of B), D (formerly "C"), E (formerly "D")

Length and Grid quantizing

The MINIAK records your playing at a very high resolution. The length and grid settings that you select for playing back your Rhythms are used to non-destructively quantize those recordings.

So, if you record a four-bar Rhythm and change its length later to 1/4 bar, the MINIAK will only play a fraction of your Rhythm, but it will remember the whole thing. If you want to change the length back to four bars at any time, the complete Rhythm will still be available.

Similarly, Rhythms are quantized using the grid setting, but the underlying information remains untouched. So, as you cycle through different grid settings, you're likely to hear different syncopations and "feels" emerge.

5. Grid

Choose **8, 12, 14, 16, 20, 24,** or **32** steps per bar. Shortening the scale decreases the quantizing resolution. You're more likely to hear double notes and simpler syncopations at low values.

Straight-ahead feels tend to result from using **8, 16,** and **32** steps per bar. Swing and shuffle feels tend to result from choosing **12** or **24** steps per bar. But you can also create different rhythms by using fractions of bars along with less obvious grid values, like **14** and **20**.

6. Record rhythm (real-time)

Once you've reached the "record" parameter, you'll hear the metronome start to click. Use this "lead-in" time to get yourself into the groove. (As always, if the tempo isn't right, you can use the **[TAP TEMPO]** button to adjust it.)

Once you're ready to play, just start playing on the white keys above middle A. The MINIAK will begin recording from the first note of the rhythm. Alternately, if you don't want to play from the first note, you can push the **DATA DIAL** to kick off the recording.

The Rhythm will loop continuously, so you can add to it each time it comes around. You can play the entire Rhythm at once, or add to it drum by drum.

When recording in real-time, remember that playing will never erase anything you've already recorded. To wipe out a section so you can replay it, you can hold down the **DATA DIAL** as it gets played back. This will wipe the notes for all drums.

However, you frequently will want to wipe out the notes for just a single drum, leaving the other drums intact. Holding down a black key will make the MINIAK wipe the notes of the last drum played (the drum shown on the display).

To stop recording, turn the **DATA DIAL** or press a mode button.

You will often want to clear the entire Rhythm and start over. One way of doing this is to hold down the **DATA DIAL** and wipe out the Rhythm as you record. But a quicker way is to hold down the **[RHYTHMS]** button and hit the highest note on the keyboard. As long as you have less than ten drums, this will jump you to the "Clear rhythm?" option.

7. Drum A through Drum H

Turn the **DATA DIAL** clockwise to access the Drum A settings. Each drum holds lots of options:

- Change the drum Program
- Edit the level
- Edit the pan position
- Edit the drum's Sequence, including the placement and velocity of each note
- Clear the Sequence information
- Remove the drum

a. Program: Press the **DATA DIAL** once to change the drum program. Twirl the **DATA DIAL** to cycle through the programs.

In order to quickly jump between Program categories, you can hold down the **[RHYTHMS]** button and press the white keys labeled with category names. Although you will almost always want to use Programs from the "Drum" category in your Rhythms, you are free to choose any Program you like. However, if you choose a non-drum, the Rhythm will only play it at middle C. If you want melodic variation, that's what Sequences are for.

Four Beats per Bar

All MINIAK Sequences have four beats per bar.

*You can still create odd-meter Rhythms. It just takes a little calculation and a willingness to ignore the tempo indications given by the **[TAP TEMPO]** button.*

For instance, one way to create a 3/4 feel is to combine a length of 1/2 bar with a grid of 24 steps. That will give you a total of 12 steps to work with.

Ignore the display's "6 + 6" grouping. Think "4 + 4 + 4" instead.

Changing the metronome

The metronome you hear when recording is, in fact, just another Sequence. It is named "Metronome", and appears near the beginning of the Sequence list. You are free to edit this Sequence all you like. For example, you can choose a different program, or put the clicks on eighth notes or triplets instead of quarter notes. A quick way of disabling the metronome entirely is to simply rename this Sequence and store it. You can always bring back the metronome later with another rename.

Switching among drums

*To quickly switch between the drums in a rhythm, hold down the **[RHYTHMS]** button and press a white key on the right side of the keyboard. For example, if you are editing "Drum A level", hold down **[RHYTHMS]** and press the B above middle C to jump to "Drum B level." This is especially useful while step editing.*

Another way of setting the Rhythm's Program is to bring it over from Programs Mode. Press **[PROGRAMS]** to enter Programs Mode, and find the Program that you want. Then, hold down **[PROGRAMS]** and press **[RHYTHMS]**, and the Rhythm's Program will be set. This works in the other direction as well—hold down **[RHYTHMS]** and press **[PROGRAMS]** to bring the Rhythm's Program over to Programs Mode, perhaps for some quick editing.

When you've found the Program you want to use for this drum, press the **DATA DIAL**.

b. Level: Turn the **DATA DIAL** clockwise to edit the drum's overall volume.

c. Pan: Turn the **DATA DIAL** to edit the drum's position in the stereo field.

d. Sequence: Turn the **DATA DIAL** clockwise to edit the drum's Sequence. (Remember, this will edit the Sequence for just this one drum, not for all the drums that make up the Rhythm setting.) Press the **DATA DIAL** to edit the Sequence. The display will show a grid like this one:

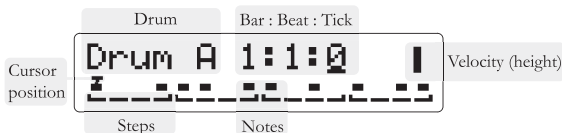

In the top line, the screen indicates that Drum A is being edited in Step mode. The cursor is at bar 1, beat 1, tick 0, shown as 1:1:0.

In the bottom line, each of sixteen steps is shown. Rectangles appear where notes are present.

Turn the **DATA DIAL** to travel amongst the different notes in the Sequence. For Sequences that require more than one screen, keep turning the knob – the display will track your position in its upper right position.

Adding notes: To add a note, press the white key that corresponds to that particular drum. For instance, drum A is controlled using the A above middle C, labeled voice. Your velocity information will be recorded, as well as the position of the **(PITCH)**, **(MOD1)**, and **(MOD2)** wheels.

Note that you can press multiple keys at once in order to place multiple drums at a step. In fact, you can enter an entire Rhythm at once simply by playing it on the keys, as long as each step has at least one drum note.

If you play a key that does not correspond to any drum, the cursor will advance, but the Rhythm will not be changed. When entering a Rhythm, sometimes it's helpful to continuously tap on the highest note of the keyboard, to control the rate at which the cursor advances.

After pressing the key, the cursor will automatically advance one step.

Removing notes: To remove a note, press any black key on the right side of the keyboard. The step will be erased, and the cursor will advance one step. The note is only removed from the drum that is displayed on the screen; all other drums are not affected.

This makes it easy to replace the Sequence for a particular drum without explicitly erasing it beforehand. Simply play the Sequence into the step editor, using a black key as a "rest."

Changing note velocities: Again, you must be in the Sequence editing screen for that particular note's Program. Place the cursor over the note you want to edit and press the **DATA DIAL** normally. You will be able to change the velocity by turning the **DATA DIAL**. You can remove the note by turning the velocity down to zero.

While you're editing velocity, you can play any key to hear what the note sounds like at that velocity. You will hear all drums which have notes at the step.

Time display

The MINI AK displays time as "bar:beat:tick". There are four beats in a bar, and 120 ticks in a beat.

Three-step beats land on 0, 40, and 80.

Four-step beats land on 0, 30, 60, and 90.

Five-step beats land on 0, 24, 48, 72, and 96.

Clear?: To keep the Program but remove all the notes, choose Clear.

Remove?: If this particular drum is unnecessary to your Rhythm, remove it. At the Remove? prompt, press the **DATA DIAL**. This drum will be removed from the Rhythm, and all of the other drums will be re-lettered accordingly. (For instance, what had been "Drum B" will become "Drum A," and what had been "Drum C" will become "Drum B.")

8. Add?

After the last drum, you will be prompted with Add? Press the **DATA DIAL** to add a drum. It will be given the next available letter.

9. Clear rhythm?

Press the **DATA DIAL** to erase all notes and controller movements from the rhythm, but keep the basic rhythm parameters. To quickly jump to this option, hold down the **[RHYTHMS]** button and press the highest note on the keyboard.

10. Rhythm name

Since Rhythms are listed alphabetically, creative naming can help you move smoothly from one Rhythm to another.

Turn the **DATA DIAL** to select a position (1 – 14) to edit. Then press the **DATA DIAL** to edit that position. Edit either by turning the **DATA DIAL** or pressing notes on the keyboard.

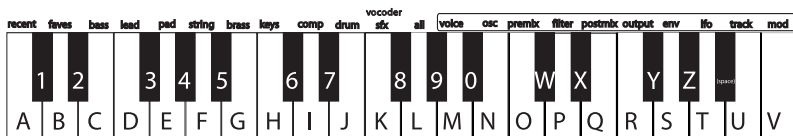

Press a key twice to toggle between upper and lower case.

Inserting and deleting characters: To insert a space in the name, navigate to the position at which you want to add the space. Hold down the **DATA DIAL** and turn it clockwise. To delete a character, navigate past it, hold down the **DATA DIAL**, and turn it counterclockwise. (In both cases, imagine that you are "dragging" the name around.)

11. Send MIDI sysex?

Choose this option to send the Rhythm to a computer or other MIDI storage device using the MINI AK's (MIDI OUT) port.

This allows you to back up your rhythms to your computer, or share them with others. (See Chapter 8 for details on what Sysex is and how to use it.)

12. Send syx bundle?

Choose this option to send both the Rhythm and its Program to a computer or other MIDI storage device using the MINI AK's (MIDI OUT) port.

13. Delete rhythm?

Delete the Rhythm using this function, if desired. You will be prompted to confirm this action.

14. Store a copy?

Unlike many synths, the MINI AK does not have fixed "banks" of Programs, Sequences, and so on, each with a predetermined number of storage locations. Instead, you may freely create and delete Rhythms at any time, just as you would on a computer.

"Store a copy?" is how you create a new Rhythm. This option creates a brand new copy of the current Rhythm, differing only in name. Now, when you make changes and hit the **[STORE]** button, you will be storing to this new copy.

Whenever you want to start a new Rhythm from scratch, you will have to find an existing Rhythm to base it off of, and then store a copy. Don't forget to store a copy, or you might accidentally overwrite the original Sequence.

Store your changes!

Be sure to press the **[STORE]** button after you're satisfied with your changes. Otherwise, your changes will be lost when the MINIAK is turned off.

However, keep in mind that you don't lose any changes when you switch to other modes, so feel free to browse through Programs or Multis without storing your Rhythm. Additionally, if you play a Multi that uses the current Rhythm, you'll hear your edited version, even without storing. This is a great way of checking how your edits sound in the context of a Multi, without having to commit to them.

You can even play other Rhythms without losing your edits. Just hit the **[RHYTHMS]** button and turn the **DATA DIAL**. You can always come back to your edited Rhythm, just as you left it. The MINIAK doesn't discard your edits until you start editing a different Rhythm.

Exiting Rhythm editing

You can exit Rhythm editing at any time. Simply press any of the buttons encircling the **DATA DIAL**, including the **[RHYTHMS]** button a second time.

CHAPTER 5: MULTIS

PLAYING MULTIS

Press **[MULTI]** and spin the **DATA DIAL** to play different Multis.

Since Multis often have different elements assigned to different parts of the keyboard, be sure to play throughout the keyboard range to experience the splits and combinations.

Multis pull together Programs, Sequences, and Rhythms to produce lush soundscapes, intricate rhythmic and sonic textures, and sophisticated keyboard "splits."

Multis depend on Programs, Sequences, and Rhythms:

*When you make changes to **[PROGRAMS]**, **[SEQUENCES]**, or **[RHYTHMS]**, the Multis that reference them will reflect those changes.*

MULTI COMPONENTS

Multis are constructed of two basic elements:

Parts: Parts hold Programs and Sequences along with level, pan, and other settings.

Beats: Beats hold Rhythms along with similar settings.

Polyphony considerations

The MINIAK allows you to stack together more sound sources than its engine can play. If you find this happening, consider restricting the key ranges of some of your parts and beats so that fewer voices sound when you press each note.

EDITING MULTIS

Multi editing has a lot of parts, as shown below. On the top level, it involves:

- Adding and removing Programs to Multi parts
- Adding and removing Sequences to Multi parts
- Adding and removing Rhythms to Multi beats
- Assigning controllers
- Assigning levels, left/right panning, key ranges, splits, etc.
- Assigning effects types and effects levels per part and beat
- Naming the Multi

Store your Multi

*The **[STORE]** button will light once you have edited a Multi.*

*Press **[STORE]** after you're satisfied with your edits. Otherwise, your changes will not be saved.*

Remember that, in most cases, pressing the **DATA DIAL** twice quickly (double-clicking) can restore a setting to the original factory setting.

**MULTI OPTIONS
(1 OF 2)**

Take a moment to cycle through these options. Press **[MULTI]** and turn the **DATA DIAL** to select a Multi to edit. Then press the **DATA DIAL** to enter edit mode.

Turn the **DATA DIAL** clockwise to cycle through the various parts. Parts are labeled as "Part A," "Part B," "Part C," etc.

Revert → stored?
(Arpeggi groove)

Part A program
(sequence's PGM)

Part A sequence
Bobbetty

Part A level
89% [-----]

Part A EAD
27% R (←)

Part A fx mix
75% dry, 25% wet

Part A low key
A3 ← [-----] E4

Part A high key
A3 [-----] → E4

Part A transpose
+7 semitones

Part A latch
not latched

Part A controllers
F, m1, m2

Part A knobs
X, Y, Z

Part A pedals
sus, expr

Part A: Selit?
(Bobbetty)

Part A: Layer?
(Bobbetty)

Part A: Remove?
(Bobbetty)

·
· (other parts)

Part D: Add?

After the last part, you will see that you can add a part.

**MULTI OPTIONS
(2 OF 2)**

Turn the **DATA DIAL** further to cycle through all of the beats. Beats are labeled "Beat A," "Beat B," "Beat C," etc. – just like parts.

Beat A rhythm
Frumpy

Beat A level
85% [-----]

Beat A fx mix
100% dry, 0% wet

Beat A low key
C0 ← [-----] C4

Beat A high key
C0 [-----] → C4

Beat A latch
not latched

Beat A: Selit?
(Frumpy)

Beat A: Layer?
(Frumpy)

Beat A: Remove?
(Frumpy)

(other beats)

Beat C: Add?

Fx: Fx Balance
0% fx1, 100% fx2

Fx: Fx1 Ives
bypass pitch fx

(fx parameters)

Fx: Fx2 Color
91%

Clear Multi?
(Arpeggi groove)

Multi name: 1
[Arpeggi groove]

Delete Multi?
(Arpeggi groove)

Send MIDI sysex?
(Arpeggi groove)

Send syx bundle?
(Arpeggi groove)

Store as copy?
(67% free space)

After the last beat, you can add a new beat.

Keep turning the **DATA DIAL** clockwise to cycle through screens dedicated to the effects. These screens will vary depending on the effect you choose.

Finally, you'll see the clear, name, delete, MIDI SysEx, and copy screens.

1. Parts

Each part has the following editable parameters:

a. Program: You can make the Program dependent on this part's Sequence, shown on the MINIAK as (*Sequence's pgm*). If you do so, the Multi will change Programs automatically as the Sequence is changed. Alternately, you can specify that the part use a particular Program.

To use the Sequence's Program, spin the **DATA DIAL** all the way to the left, or press the **DATA DIAL** twice in quick succession (double-click).

To specify another Program, twist the **DATA DIAL** to find the Program you want. (To jump to a category, hold down the **[MULTI]** button and press one of the lower white keys.)

Another way of setting the part's Program is to bring it over from Programs Mode. Press **[PROGRAMS]** to enter Programs Mode, and find the Program that you want. Then, hold down **[PROGRAMS]** and press **[MULTI]**, and the part's program will be set. This works in the other direction as well – hold down **[MULTI]** and press **[PROGRAMS]** to bring the part's Program over to Programs mode, perhaps for some quick editing.

Press the **DATA DIAL** again to accept your selection.

b. Sequence: Select the Sequence to be used in this part. If you don't want to use a Sequence, turn the **DATA DIAL** all the way to the left (or double-click) to select *none*.

As with Programs, you can also set the Sequence by bringing it over from Sequences Mode. Press **[SEQUENCES]** to enter Sequences Mode, and find the Sequence that you want. Then, hold down **[SEQUENCES]** and press **[MULTI]**, and the part's Sequence will be set. This works in the other direction as well – hold down **[MULTI]** and press **[SEQUENCES]** to bring the part's Sequence over to Sequences Mode.

c. Level: Adjust the part's overall level relative to the other levels and parts within this Multi.

d. Pan: Adjust the part's left/right pan position.

e. FX Mix: Set the dry/wet effects balance for the part.

A part that is "100% dry" does not use the master effects at all. On the other hand, if you set a part to "100% wet," all you'll hear is what comes out of the master effects. The correct effects balance to use depends on the particular effect, but for most effects such as phasers and choruses, "70% dry, 30% wet" is a good place to start. When using the vocoder, you typically don't want to hear any dry at all, so set the balance to "100% wet."

f. Low Key: Carefully assigning parts and beats to different portions of the keyboard can make the difference between good Multis and awesome ones.

In this screen, set the lowest keyboard note to which the part will respond. Any notes lower than the note you select here will be ignored by this part.

To select a note, turn the **DATA DIAL** or play a key. You can use the **[OCTAVE]** buttons if your desired note is outside of the current key range.

Switching amongst parts and beats

To quickly switch between the parts and beats in a Multi, hold down the **[MULTI]** button and press a white key on the right side of the keyboard. Parts start at the A above middle C, and beats start at the A above that.

For example, if you are editing "Part A level," hold down **[MULTI]** and press the B above middle C to jump to "Part B level." If you get lost in your Multi and can't remember which part is which, try holding down **[MULTI]** and running your fingers across the right side of the keyboard.

Experiment with using one Program for multiple parts

You can assign one program to a number of different parts. Varying levels, Sequences, transpositions, and more across the parts can create some interesting and musical results.

Setting the level to zero

Set the level to 0 to turn a part off without removing it.

Consider using this tactic works when you're not entirely sure whether you want to keep a part or not.

Use As

Following the Sequence screen, you may encounter a screen saying "use as," with your choices being "instrument" or "drum." Continue reading this chapter for details on this feature.

Effects

All of the parts and beats within a Multi use either no effect or else a single, shared effect (which is selected in a later screen).

g. High Key: Set the highest keyboard note to which the part will respond. Any notes higher than the note you select here will be ignored by this part.

Remember that you can set these keys across the entire MIDI note number range, not just the MINI AK's 37 notes. Remember that you can always use the **[OCTAVE]** buttons to adjust the note range of the MINI AK's keyboard.

h. Transposition: Adjust the transposition over a four-octave range. This does not affect the MIDI notes that the part responds to. It simply changes the pitch at which the program is played.

i. Latch: Set the latch status of the part to *latched* or *not latched*. The default is *not latched*.

When latch is *on*, the part will continue playing after you remove your hands from the keys, as if the sustain pedal were held down. To release the latched notes, let up on all of the keys and then play a new note or chord. To stop the part entirely, switch to another Multi or press a mode button.

Latching is especially useful when you have more parts than you have hands, or if your parts don't all fit within the MINI AK's three-octave key range. If your bassline and pad parts are latched, you can simply let them play on their own while you use both hands to play the lead, and then return to them when it's time for a chord change.

Latching with the **[LATCH ARP]** button is similar. If you hold down the **[LATCH ARP]** button and play an unlatched part, it will become latched as long as the button is activated.

j. Controllers: Activate any combination of the **(PITCH)**, **(MOD1)**, and **(MOD2)** wheels for this part.

You will often want each controller to affect just a single part. For example, you might want the **(PITCH)** wheel to bend the lead, or the **(MOD2)** wheel to sweep the filter of your pad. To assign a controller exclusively to the current part, hold down the **[MULTI]** buttons and wiggle the controller. This will not only enable the controller for this part, but will also disable the controller in all other parts.

k. Knobs: Allow any combination of the **x**, **y**, and **z** knobs to work on this part. The knobs' functions are determined by the settings assigned for this part's program within the **[PROGRAMS]** screens.

As with controllers, you can assign a knob exclusively to the current part by holding down the **[MULTI]** buttons and wiggling the knob. This will enable the knob for this part and disable the knob in all other parts.

As always, when you turn a knob, the display will indicate which Program parameter you're changing. If you have multiple parts that respond to the same knob, the display will only show this information for a single part, but rest assured that all of the parts are being affected.

l. Pedals: Assign the sustain and/or expression pedal to this part. By default, they are both assigned.

m. Split?: Split allows you to create a new part by splitting the key range of the current part. After the split, one part will use the keys below the split point, and the other part will use the keys above. The two parts will otherwise be identical.

If you choose to split a part, the MINI AK will prompt you to select the key on the keyboard where the split should occur. To select the split point, turn the DATA DIAL or play a key. You can use the **[OCTAVE]** buttons if your desired split point is outside of the current key range.

Carving out a hole in the keyboard range

When you set the Low Key higher than the High Key. In such cases, the notes in between the two will be silent, but all notes outside of that range will play, resulting in a hole in playing range.

Some transposition tips

The MINI AK's compact keyboard makes transposition especially important.

Some lush sounds can be made by combining some programs at standard pitch with others transposed an octave or two higher or lower, but reduced in level.

Some classic synthesizer sounds combine one non-transposed part with another—lower in level—a fifth above (that's plus-seven semitones). While this setting violates every rule held sacred by harmony professors, you may be among the many who find it very cool.

Jumping between parts

*To jump between parts, hold down the **[MULTI]** button and press a key on the right side of the keyboard, starting with the A above middle C.*

The newly-created part will be assigned the next letter after the current part's letter. All subsequent part letters will be incremented by one.

n. Layer?: Choose *layer* to duplicate the current part. The newly-created part will be assigned the next letter after the current part's letter. All subsequent part letters will be incremented by one.

o. Remove?: Choose *remove* to remove the current part. All subsequent parts will be re-lettered accordingly.

2. Use as

Suppose you come across a Rhythm that would fit perfectly in your Multi, but the snare drum doesn't sound right. You could edit the Rhythm, but that would affect all other Multis using that Rhythm. Instead, what you'd like to do is just swap out that particular drum within this particular Multi.

To do this, choose a Program to replace the errant snare, and add it to the Multi as a part. As long as the Program is in the "drum" category and there is no Sequence assigned, a hidden option will appear after the Sequence parameter: "use as".

Normally, this parameter is set to "use as instrument," indicating that the part is functioning like any other part. But if you change the parameter to "use as drum A in beat", all rhythms will substitute the part's Program for their drum A. You can "use as" any drum from A to J. Once you figure out which drum that snare is, you can replace it with any Program of your choosing.

"Use as" doesn't just affect a drum's Program – the drum's level, pan, and FX mix follow the part's settings as well. So, if you actually like the snare's Program but think it's a bit too loud, "use as" can help you turn down the level. Or, if you want most of the Rhythm dry, but want to give that snare some extra effects processing, "use as" will allow you to adjust its FX mix individually.

3. Add?

After turning the **DATA DIAL** past all of the current parts, you will be able to add a part. At the add screen, push the **DATA DIAL** to add a new, empty part.

Note that adding parts using the add feature always adds them after the last part. To insert a part in between other parts, use the split or layer functions from within the part editing screens.

4. Beats

Once you are past the part screens, you reach the beat screens.

a. Rhythm: Choose the rhythm to use for this beat. All of the information for the Rhythm – the sounds, panning, relative levels of the different sounds, and so forth – will be included.

Another way of setting the beat's rhythm is to bring it over from Rhythms mode. Press **[RHYTHMS]** to enter Rhythms mode, and find the rhythm that you want. Then, hold down **[RHYTHMS]** and press **[MULTI]**, and the beat's rhythm will be set. This works in the other direction as well—hold down **[MULTI]** and press **[RHYTHMS]** to bring the beat's rhythm over to Rhythms mode, perhaps for some quick editing.

b. Level: Set the level of this beat relative to the other beats and parts within the Multi.

c. FX Mix: Set the dry/wet effects balance for the beat. This mix affects all of the drums in a Rhythm equally. If you want to single out a particular drum, see the "use as" parameter above.

d. Low Key: Carefully assigning parts and beats to different portions of the keyboard can make the difference between good Multis and awesome ones.

In this screen, set the lowest keyboard note to which the beat will respond. Any notes lower than the note you select here will be ignored by this beat.

To select a note, turn the **DATA DIAL** or play a key. You can use the **[OCTAVE]** buttons if your desired note is outside of the current key range.

Using multiple beats per Multi

A Multi can have multiple beats, just as it can have multiple parts. Assigning different beats to different, small little sections on the keyboard (using the "low key" and "high key" parameters) can provide you with a lot of variations as you perform.

Effects

All of the parts and beats within a Multi use either no effect or else a single, shared effect (which is selected in a later screen).

e. High Key: Set the highest keyboard note to which the beat will respond. Any notes higher than the note you select here will be ignored by this beat.

Remember that you can set these keys across the entire MIDI note number range, not just the MINIAK's 37 notes.

Remember that you can always use the **[OCTAVE]** buttons to adjust the note range of the MINIAK's keyboard.

f. Latch: Set the latch status of the beat to latched or not latched. The default is not latched.

When latch is on, the beat will continue playing after you remove your hands from the keys. If you play a key that is mapped to a different latched beat, this beat will stop and the new one will play instead. To stop the beat entirely, hit the **[PATTERN PLAY]** button or switch to another mode.

Latching is especially useful when you have more parts than you have hands, or if your parts don't all fit within the MINIAK's three-octave key range. If your bassline and pad parts are latched, you can simply let them play on their own while you use both hands to play the lead, and then return to them when it's time for a chord change.

Latching with the **[LATCH ARP]** button is similar. If you hold down the **[LATCH ARP]** button and play an unlatched beat, it will become latched as long as the button is activated.

g. Split?: Split allows you to create a new beat by splitting the key range of the current part. After the split, one beat will use the keys below the split point, and the other beat will use the keys above. The two beats will otherwise be identical.

If you choose to split a beat, the MINIAK will prompt you to select the key on the keyboard where the split should occur. To select the split point, turn the **DATA DIAL** or play a key. You can use the **[OCTAVE]** buttons if your desired split point is outside of the current key range.

The newly-created beat will be assigned the next letter after the current part's letter. All subsequent beat letters will be incremented by one.

h. Layer?: Choose layer to duplicate the current beat.

The newly-created beat will be assigned the next letter after the current beat's letter. All subsequent beat letters will be incremented by one.

i. Remove?: Choose remove to remove the current beat. All subsequent beats will be re-lettered accordingly.

Jumping between beats

To jump between beats, hold down the **[MULTI]** button and press one of the top keys, starting with the highest A on the keyboard.

Silencing the beats

If you want to disable a Multi's beats, press **[PATTERN PLAY]**. This turns all the beats off. Press **[PATTERN PLAY]** a second time to reactivate the beats.

Carving out a hole in the keyboard range

When you set the Low Key higher than the High Key, the notes in between the two will be silent, but all notes outside of that range will play, resulting in a hole in playing range.

5. Add?

After turning the **DATA DIAL** past all of the current beats, you will be able to add a beat. At the *add* screen, push the **DATA DIAL** to add a new beat.

Note that adding beats using the *add* feature always adds them after the last beat. To insert a beat in between others, use the *split* or *layer* functions from within the beat editing screens.

6. FX Balance, FX Type 1, FX Type 2

Choose an effect to apply to the Multi, or turn the **DATA DIAL** all the way to the left (or double-click the **DATA DIAL**) to bypass the effects.

If you do choose an effect, the editable parameters associated with that effect will be shown in subsequent screens.

Each part and beat has an "FX mix" parameter to control how much of its sound is passed through the master effects section. If a part or beat is set to "100% dry," it is unaffected by the Multi's effects.

7. Clear

Choose *clear* to remove all of the parts and beats from the Multi but to retain the Multi's name.

8. Multi name

Since Multis are listed alphabetically, creative naming can help you move smoothly from one Multi to another.

Turn the **DATA DIAL** to select a position (1 – 14) to edit. Then press the **DATA DIAL** to edit that position. Edit either by turning the **DATA DIAL** or pressing notes on the keyboard.

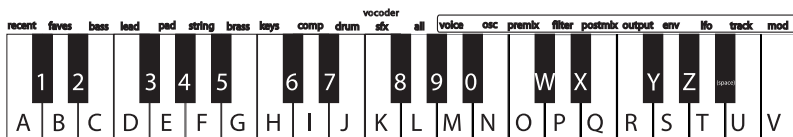

Press a key twice to toggle between upper and lower case.

Inserting and deleting characters: To insert a space in the name, navigate to the position at which you want to add the space. Hold down the **DATA DIAL** and turn it clockwise. To delete a character, navigate past it, hold down the **DATA DIAL**, and turn it counterclockwise. (In both cases, imagine that you are "dragging" the name around.)

9. Send MIDI sysex?

Choose this option to send the Multi to a computer or other MIDI storage device using the MINIAK's (**MIDI OUT**) port.

This allows you to back up your Multis to your computer, or share them with others. (See Chapter 8 for details on what Sysex is and how to use it.)

10. Send syx bundle?

Choose this option to send both the Multi and its Program, Sequences, and Rhythms to a computer or other MIDI storage device using the MINIAK's (**MIDI OUT**) port.

11. Delete Multi?

Delete the Multi using this function, if desired. You will be prompted to confirm this action.

12. Store a copy?

Unlike many synths, the MINIAK does not have fixed "banks" of Programs, Sequences, and so on, each with a predetermined number of storage locations. Instead, you may freely create and delete Multis at any time, just as you would on a computer.

"Store a copy?" is how you create a new Multi. This option creates a brand new copy of the current Multi, differing only in name. Now, when you make changes and hit the **[STORE]** button, you will be storing to this new copy.

Whenever you want to start a new Multi from scratch, you will have to find an existing Multi to base it off of, and then store a copy. Don't forget to store a copy, or you might accidentally overwrite the original Multi.

Store your changes!

Be sure to press the **[STORE]** button after you're satisfied with your changes. Otherwise, your changes will be lost when the MINIAK is turned off. However, keep in mind that you don't lose any changes when you switch to other modes, so feel free to browse through Programs or Rhythms without storing your Multi.

You can even play other Multis without losing your edits. Just hit the **[MULTI]** button and turn the **DATA DIAL**. You can always come back to your edited Multi, just as you left it. The MINIAK doesn't discard your edits until you start editing a different Multi.

Exiting Multi editing

You can exit Multi editing at any time. Simply press any of the other buttons encircling the **DATA DIAL**, including the **[MULTI]** button a second time.

CHAPTER 6: PROGRAMS

WHAT IS A PROGRAM?

A MINIAK program is a sound built from the MINIAK's internal oscillators, filters, and envelope generators. The MINIAK's programs cover the gamut of classic analog synthesizer sounds. If you've heard it before, you will probably find it amongst the MINIAK's presets.

HOW THE MINIAK MAKES SOUND

The MINIAK generates sound by emulating, or "modeling," the behavior of an analog synthesizer. Oscillators generate the raw sounds. The oscillators are then fed into the filters, which in turn are fed into the amplifiers.

As the signal moves through that basic path, you are able to adjust the mix of the signal at several points, apply various modulations and envelopes, and add effects. In this way, the MINIAK can generate a virtually limitless variety of sounds.

Let's take a quick look at the MINIAK's signal path, from start to finish.

The Oscillators

The oscillators are where sound is born. You may have heard that what you perceive as "sound" is simply vibrating air molecules hitting your eardrums. That vibration has to start somewhere, and in the end, it comes from the oscillators. By varying the *frequency* of the vibration, the oscillators can produce different pitches, which are heard as musical notes. By adjusting the *waveform type* and *shape*, the oscillators can produce various harmonics, which are heard as different timbres. Each of the MINIAK's voices contains three oscillators.

The Pre-Filter Mix

The outputs of the oscillators, as well as a few other signal sources, are fed into a virtual mixing board called the Pre-Filter Mix. The job of this mixer is to funnel all of these sources into the inputs of the next sound processing stage – the filters. For each source, you can specify its *level*, which is how loud it should be, and its *balance*, which determines how much of it goes to Filter 1 and how much to Filter 2.

The Filters

The sound produced by the oscillators is very raw, and usually not suitable to be used directly in an instrument. In order to bring out the sonic textures you have in mind, you will typically want to dampen certain harmonics and boost others. This is where the filters come in. Filters alter the frequency content of the signal, and can have a drastic effect on the sound. A filter typically allows you to adjust its *cutoff frequency*, which represents the range of harmonics that the filter operates on, as well as its *resonance*, which determines how much boost is given to harmonics around the cutoff frequency. Each of the MINIAK's voices contains two filters, and each filter can be one of eighteen different types, each with its own character and sonic flavor.

The Post-Filter Mix

The outputs of the filters need their own virtual mixing board as well, and that's what the Post Filter Mix is for. For each filter output, as well as a pre filter signal of your choice, you can specify a *level*, which is how loud it should be, and a *pan*, which determines how much goes to your left speaker and how much to the right.

Output

The sound is getting near the end of its journey, but still has one more processing stage to go through. In the output stage, the MINIAK allows you to apply a *drive effect*, to give the sound a final push and add some compression, distortion, or other amplification effect. You also get to choose the overall level for the sound, as well as how much of it gets sent to the MINIAK's dedicated effects processor.

Signal Flow Diagram

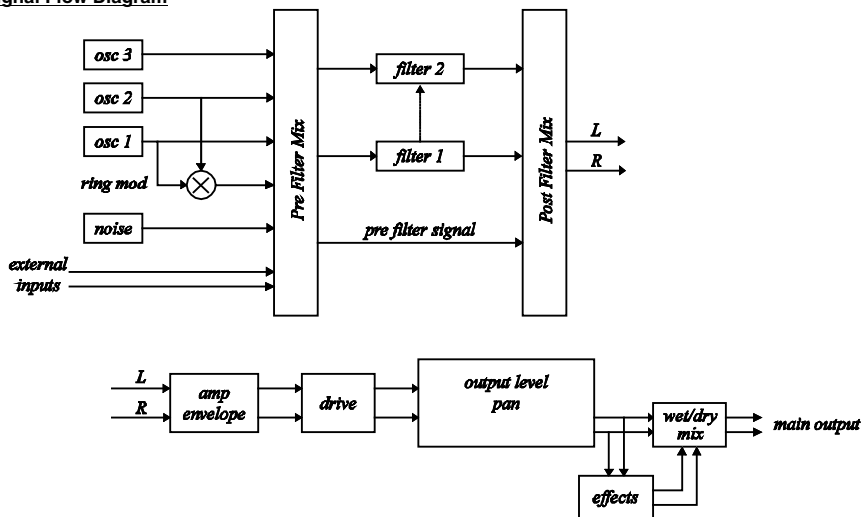

MODULATION

At this point, you may think that producing a sound with the MINIAK is simply a matter of configuring the parameters for the oscillators, filters, and mixers, and then hitting a key. And although it's true that you can design some nice instruments this way, generating the really awesome sounds invariably involves tweaking some of those parameters while a note is playing. The problem with that, if you're anything like us, is that you only have two hands, and you are probably using at least one of them to hit the notes in the first place. Fortunately, the MINIAK is willing to lend you a helping hand — twelve of them, in fact.

The MINIAK allows you to set up twelve *modulation routes*. Each of these is a virtual connection between some physical or internally-generated source and some program parameter. Basically, a mod route tells the synth to automatically grab a knob and tweak it while a note is playing. Although there are quite a few sources that you can use for your mods, the most common ones involve the LFOs and the envelopes.

The LFOs

LFO stands for "low frequency oscillator". Unlike the normal oscillators, however, the LFOs are not designed for producing sound. Instead, their purpose is to tweak a program parameter according to a looping pattern. For example, if you are looking to add some vibrato to your instrument, you'll need the pitch to continuously waver up and down. An LFO is perfect for this application. Simply hooking up an LFO to the oscillator pitch parameter will get you the effect you need. Each of the MINIAK's voices contains two LFOs.

The Envelopes

If you hit a note on a piano, you'll hear a burst of sound energy as the hammer strikes the string, followed by lower level of loudness as you hold down the note and let the string ring out, which fades quickly as soon as you release the note and the damper is applied. Synthesizer designers model this behavior using *ADSR envelopes*. ADSR stands for "attack, decay, sustain, release", and represents the different stages that the sound goes through over the life of the note. Since the most important application of the envelope is to control the loudness of the sound, the MINIAK provides one envelope that is specifically designed for this purpose. This is the *amp envelope*. However, envelopes are useful in all sorts of mod routes, which is why you can hook up any of the MINIAK's envelopes to any modulatable program parameter.

Envelope assignments

Envelopes can affect different parameters depending on the modulation routes you assign.

Each of the MINIAK's voices contains three envelopes. "Env1" is the *amp envelope*. "Env2" is the *filter envelope*. "Env3" is the *pitch/modulation envelope*.

PLAYING PROGRAMS

Press the **[PROGRAMS]** button to enter Programs Mode. Release the **[PROGRAMS]** button and spin the **DATA DIAL** to cycle through the Programs first by category and then – after you have reached the last Program within the last category – again in alphabetical order.

You can also quickly switch to any category by holding down **[PROGRAMS]** and then pressing the white key on the MINIAK's keyboard labeled with that category.

Note that the "recent" category is generated automatically. The "faves" category is controlled by you, as detailed in the next discussion.

EDITING PROGRAMS

1. Revert-to-Stored? / Unrevert-to-Edited?

If you have edited a Program, you may revert back to the original version. Once you are on this page, press the **DATA DIAL** to revert.

Go back to your edited state by pressing the **DATA DIAL** a second time to *unrevert*.

Use *revert* and *unrevert* often in order to compare your changes to the original Program. When you're satisfied with your work, press **[STORE]** to save your changes.

2. Add to Faves? / Remove Fave?

Press the **DATA DIAL** to enter edit mode. Once you are on this page, press it again to add this Program to the *faves* (favorites) list. When you make a Program a fave, it is accessible not only in its own category but also in the *faves* category.

To remove the program from your *faves* list, first select it in the *faves* category (see the sidebar) and then enter edit mode by pressing the **DATA DIAL**. "Remove fave?" is the first option you will see. Press the **DATA DIAL** to confirm the action.

Accessing Faves

*Press and hold the **[PROGRAMS]** button and press the low D key (labeled "faves") to access the Programs you've stored in the faves category.*

3. Send to Multi?

Pressing the **DATA DIAL** at this option sends you to **[MULTI]** mode and allows you to make this Program a part in the last-selected Multi.

Any existing Multi already has one or more parts, so you will be given the option of adding this Program to the Multi in one of the following ways:

1. **send to part.** The Multi's part's is replaced by the current Program. The Multi part's level, effects mix, key range, and latch status are retained. See the sidebar for a description of how the parts' letter assignments are affected.

2. **layer.** The Multi's existing part is duplicated, resulting in a new part. This new part uses the Program but retains the level, effects mix, and other information of the Multi's original part. See the sidebar for a description of how the parts' letter assignments are affected.

3. **split low.** The Multi's existing part is split in two at a particular key. The MINIAK prompts for a note on the keyboard at which to execute the split. The Program is then sent to the lower part of the split. Every note *below* the one you select will use this new program, down to that part's low key setting. Every note *including and higher than* the note you select will use the Multi's existing part.

The new part is assigned the letter of the part that was split low. For example, if the Multi contains parts A, B, C, and D, and part B is the part that is split, then the newly added part will become part B, and the original part will become part C. All later parts' letters are incremented by one.

To select the split point, turn the **DATA DIAL** or play a key. You can use the **[OCTAVE]** buttons if your desired split point is outside of the current key range.

***Send to Multi** only allows the option of sending the Program to the current Multi. Therefore, you may need to jump out of Program editing to choose a Multi before returning to Programs and following this procedure.*

4. **split high.** The Multi's existing part is split in two at a particular key. As with the split low option, the MINIAK prompts for a note on the keyboard at which to execute the split. The Program is then sent to the upper part of the split. Every note *above* the one you select will use this new program, up to that part's high key setting. Every note *including and lower than* the note you select will use the Multi's existing part.

To select the split point, turn the **DATA DIAL** or play a key. You can use the **[OCTAVE]** buttons if your desired split point is outside of the current key range.

5. **add part.** The program is added as a brand new part across the entire keyboard range. All other part parameters are set to their default values as well.

4. Start New Multi?

Pressing the **DATA DIAL** at this option creates a new Multi named with the program's name and a "+" in front (e.g. "+Repeater" or "+TranceTube") and, if a Multi with this name already exists, a number at the end (e.g. "+Repeater2" or "+TranceTube2"). After doing this, you'll notice that the Program Mode button is no longer lit; the MINIAK has switched into Multi Mode.

If you have not chosen to start a new Multi, then you are still in Programs Mode. Turning the **DATA DIAL** further clockwise scrolls through the many Program editing parameters, as follows:

5. Voice parameters

Polyphony

monophonic: One note at a time.

polyphonic: Up to eight notes at a time.

Unison

one voice/note: The MINIAK's voices are distributed evenly amongst up to eight simultaneously held keys.

two voices/note: Each key triggers two voices, thereby halving the available polyphony down to four.

four voices/note: Each key triggers four voices and the MINIAK's polyphony is reduced to two simultaneous voices.

all voices/note: Reduces the MINIAK to monophonic operation, with all available voices dedicated to a single note.

UsnDetune: Select the pitch range by which unison voices will be detuned. Higher values lead to a thicker but more out-of-tune sound. (**Note:** when the unison parameter is set to one voice/note, the *UsnDetune* parameter has no effect.)

Portamento: Set the amount of "glide" between notes:

off: No portamento.

legato only: Portamento will occur only if you play a second key before lifting up the first key.

always: Portamento will occur even if there is no overlap between the lifting of one key and the playing of another.

PortaType: Set the type of portamento:

fixed: No matter how far apart the two keys are, it takes the same amount of time to travel between them. The *PortaTime* parameter determines this amount of time.

How part letters change when "layer," "split low," and "split high" are used: When parts are layered or split high, the new part is assigned the next letter after the targeted part. All subsequent part letters are incremented by one.

For example, consider a Multi with four existent parts: A, B, C, D

If we split part B, the result is as follows: A, B (low split of B), C (high split of B), D (formerly "C"), E (formerly "D")

Mapping the (X/Y/Z) knobs

Any parameter may be mapped to the **x**, **y**, or **z** knobs. When the parameter is on the screen, simply hold down the **DATA DIAL** and wiggle the knob that you want to map to.

Quick access to editing

To jump to the voice category, hold down the **[PROGRAMS]** button and press the key labeled "voice."

scaled: With this setting, the PortaTime parameter determines the amount of time it takes to glide a distance of one octave.

gliss fixed: Identical to fixed, but with the glide stepping chromatically (C, C#, D, D#, etc.) rather than smoothly.

gliss scaled: Identical to scaled, but with the glide stepping chromatically (C, C#, D, D#, etc.) rather than smoothly.

PortaTime: Set the base time for portamento to slide from note to note.

(PITCH) Wheel: When set to bend all notes, moving the **(PITCH)** wheel will bend the pitch of all voices that are sounding, even if they are being sustained by a sustain pedal or are in their release stage. When this parameter is set to bend held notes, only voices for which the keys are still depressed will allow their pitch to be bent by the **(PITCH)** wheel.

AnlgDrft: Set the amount of simulated analog drift, up to 100%. Analog synthesizers have circuits that drift out of tune over time. Adding a touch of drift can increase the realism of the MINIAK's analog emulation.

Osc Sync: Set how the oscillators synchronize to one another.

off: The oscillators sound independent of one another.

hard 2 to 1: Hard sync resets oscillator 2 to the beginning of its waveform whenever oscillator 1 hits the beginning of its waveform. This has the effect of forcing oscillator 1's fundamental frequency onto oscillator 2. This behavior is called "hard sync" because the slave waveform is "snapped" to zero at the frequency of the master oscillator, which can create a harsh, rough sound even out of sine waves.

hard 2+3 to 1: Oscillators 2 and 3 are forced to "hard sync" to oscillator 1.

soft 2 to 1: Every time oscillator 1 begins its cycle, oscillator 2 reverses direction. The resulting wave has no sharp edges, as it does with hard sync, but exhibits a mixture of harmonics that can have interesting sonic properties.

soft 2+3 to 1: Oscillators 2 and 3 are forced to "soft sync" to oscillator 1.

FM Amount: FM, or "frequency modulation," allows you to use one oscillator to control the frequency of another. Set the percentage by which the target oscillator's frequency is affected by the master oscillator's waveform.

FM Type:

A. Linear FM types

lin 2 > 1: Oscillator 2 is added to the phase of oscillator 1. Linear FM is the style used by typical FM music synthesizers. Modulating a sine wave with another, higher-frequency sine wave produces a fundamental frequency with a variety of overtones, and this can be used to reproduce the sounds of many physical musical instruments.

lin 2+3 > 1: Oscillators 2 and 3 are added to the phase of oscillator 1.

lin 3 > 2 > 1: Oscillator 3 is added to the phase of oscillator 2. The resultant waveform is added to the phase of oscillator 1.

With linear FM, the FM Amount controls the "modulation index", with a level of 100% providing an index of 32.

B. Exponential FM types

exp 2 > 1: Oscillator 2 modulates the pitch of oscillator 1.

exp 3 > 2 > 1: Oscillator 3 modulates the pitch of oscillator 2. The resultant waveform modulates the pitch of oscillator 1.

With exponential FM, the FM Amount controls the range of pitch modulation, with a level of 100% driving the pitch up and down a full six octaves.

6. Oscillator parameters

These parameters are repeated for each of the MINIAK's three oscillators.

Waveform

sine: Smooth and pure sound.

tri/saw: A triangle wave, a sawtooth wave, or anything in between. A triangle wave has a fuller sound than a sine wave, whereas a sawtooth wave has a harsh sonic character.

pulse: Harmonically the richest of the three waves, pulse can range from a very full-sounding square wave to a sharp, nasally impulse wave.

Waveshape

This parameter bends the waveform.

For the sine waveform, a shape of zero gives you a pure tone. As you increase the shape, the sine wave deforms to add higher harmonics.

For the tri/saw waveform, a shape of zero results in a triangle wave. As you adjust the shape, the wave leans left or right, ultimately becoming a down-saw or an up-saw at -100% or 100% respectively.

For the pulse waveform, the shape parameter controls the pulse width. A shape of zero gives you a square wave, and decreasing or increasing the shape will make your wave skinnier or fatter respectively.

Octave: Transposes the pitch up or down over a +/- three-octave range.

Transpose: Transposes the pitch up or down over a +/- seven-semitone range.

Pitch: Transposes the pitch over a +/- 99.9-cent range.

PWHLRange: Sets the range of the pitch wheel, from 0 semitones (off) to +/- 12 semitones (one full octave).

7. Pre-filter mix parameters

Before the sound sources are sent to the filters, they are mixed together. Use the pre-filter mix parameters to set the levels for each of the oscillators, the ring modulation, noise, and external sources. Also set the amounts of each of these sources to be sent to filter 1 (f1) and filter 2 (f2).

Also set the noise type to white or pink. White noise has the same amount of energy across all frequencies, sounding like hiss. Since there are so many more frequencies higher (in the treble range) than there are lower (in the bass range), white noise sounds trebly. Pink noise, on the other hand, progressively reduces the energy of the higher frequencies to provide an even sound across the frequency spectrum. Where white noise sounds like hiss, pink noise sounds like a roar or ocean wave.

White noise has a sharp sound which makes it especially good for percussive effects, whereas the frequency characteristics of pink noise are more soothing and pleasant to the human ear.

8. Filter parameters

Each of the two filters has the following editable parameters:

Type: Choose from a collection of classic and modern filter types:

bypass: No filter. This setting is useful for previewing the un-filtered signal.

lowpass ob_2pole: Modeled on the lowpass output of the multi-mode filter built into a classic synthesizer expander module.

lowpass tb_3pole: Modeled on the filter from a little silver bass synthesizer whose sound has become ubiquitous in many styles of electronic music.

lowpass mg_4pole: Modeled on the filter found in the most famous monophonic analog synth ever made. The filter, with a steep cutoff and deep resonance, earned much credit for its fat sound. This filter will self-oscillate at high resonance settings.

lowpass rp_4pole: Modeled on the filter in a very popular semi-modular synth. This filter will clip (distort) when fed a loud input level.

lowpass jp_4pole: Modeled on the lowpass filter from a popular 8-voice synth noted for its very colorful case and colorful, versatile sound. Compare its sound to the mg or rp filters.

lowpass al_8pole: Unique to the MINIAK. 8 poles give this filter an extremely steep cutoff.

bandpass ob_2pol: Modeled on the bandpass output of the ob multi-mode filter.

bandpass al_6pol: Unique to the MINIAK. This filter sounds like an exaggerated version of the ob bandpass.

bandpass 8vedual: Unique to the MINIAK. Two 2-pole bandpass filters, spaced 1 octave apart.

bandpass bndlimit: Unique to the MINIAK. A 2-pole highpass filter and a 2-pole lowpass filter in series, limiting the signal to everything in between them. The resonance control adjusts the bandwidth.

highpass ob_2pol: Modeled on the highpass output of the ob multi-mode filter.

highpass op_4pol: Unique to the MINIAK. A 4-pole highpass filter.

vocal formant 1: Unique to the MINIAK. Formant filters are modeled on the human voice. This 3-band (3 bandpass filters) version emulates the "ah" and "oo" vowel sounds.

vocal formant 2: Unique to the MINIAK. A 3-band formant filter which emulates the "oh" and "ee" vowel sounds.

vocal formant 3: Unique to the MINIAK. A 5-band formant filter based on an idealized model of the vocal tract.

comb 1 – 4: Unique to the MINIAK. The comb filter creates multiple resonant peaks and notches that are not harmonically related.

phase warp: Unique to the MINIAK. This is based on an analog phaser effect. Eight allpass filters in series create four harmonically related notches in the frequency response.

Freq (Frequency): Dial in the frequency at which the filter begins to operate.

Res (Resonance): Add a boost at the current filter frequency. Very high resonance settings can cause certain filter types to "whistle," or self-oscillate.

Keytrk (Key tracking): Set whether the filter frequency rises and falls to match the keys you play or stays constant regardless of the keys you play. A setting of 0 means the filter frequency will remain constant across the keyboard. If the key track parameter is set to +100, the filter tracks the keyboard perfectly, and with enough resonance, can be played as if it were an oscillator. Negative settings mean the filter will grow darker as higher notes are played.

EnvAmt (Envelope Amount): Set the degree to which the filter frequency will be affected by the filter envelope. A negative setting inverts the envelope.

Additionally, filter 2 has the following parameter:

Offset

Absolute: The value assigned for filter 2's frequency setting is applied normally.

Offset: The value assigned for filter 2's frequency is locked into a relative position with filter 1's frequency. Filter 2's frequency automatically rises and falls in step with filter 1's frequency.

9. Post-filter mix parameters

Set the mix levels and left-right pan positions for filter 1, filter 2, and the pre-filter mix. Also set the following parameters:

Prefilt Src (Pre-Filter Source): The outputs of the oscillators, as well as a few other signal sources, are fed into a virtual mixing board called the Pre Filter Mix. The job of this mixer is to funnel all of these sources into the inputs of the next sound processing stage—the filters. For each source, you can specify its level, which is how loud it should be, and its balance, which determines how much of it goes to Filter 1 and how much to Filter 2.

Fit 1 Sign (Filter 1 Polarity): Choose positive polarity for normal summing of the filter 1 and filter 2 signals. Choose negative polarity to throw the two filters out of phase with one another, creating peaks and notches at various frequencies.

10. Output

Drive Type: Select bypass for a clean sound or one of compressor, rms limiter, tube overdrive, distortion, tube amp, or fuzz pedal.

Drive Level: Set the amount of drive, from 0 to 100%.

Prgm Level (Program Level): This simple but very important parameter controls how loud your program is. When set to zero, the program is silent, whereas a setting of 100% will play it full-blast. If you hear your sound clipping, this is a good parameter to reach for. You can also use this parameter to equalize the loudness of the various programs you create, so they all sound about the same level as you flip through them, regardless of their individual oscillator, filter, and mixer settings.

FX Mix (Effects Mix): Sets the wet/dry mix for the effects-processed audio, from 0 to 100%.

FX Balance (Effects Balance): Sets the balance between the Micon's two effects modules and determines how much of each is heard.

FX1 Type (Effects 1 Type): Select bypass for no effect, or select one of the built-in pitch effects (chorus, theta flanger, thru-0 flanger, super phaser, string phaser, or 40-band vocoder).

FX1 Param (Effects Parameters): Different screens appear in this area depending on the effects type chosen. Set the effect's parameters here.

FX2 Type (Effects 2 Type): Select bypass for no effect, or select one of the built-in delay effects (mono delay, stereo delay, split L/R delay, hall reverb, plate reverb, room reverb).

FX2 Param (Effects Parameters): Different screens appear in this area depending on the effects type chosen. Set the effect's parameters here.

FX1 EFFECTS

You may choose any one of the Effects 1 module's six different pitch-based effects.

Chorus: A chorus effect uses an LFO to modulate the pitch of the input signal, which is then added back to the dry signal. In small doses this will create the illusion of multiple voices playing at once. Turn up the Feedback and Depth for more pronounced "shimmering" and "watery" sounds.

A. Feedback:

This is the amount of the chorus output added back into the input to produce a deeper effect.
Range: 0 - 100%

B. Manual Delay

This is the base delay time that is modulated by the LFO to create the Flange effect. It determines the frequencies of the notches and peaks.
Range: 0 – 100%

C. LFO Rate

This is the rate of the Low Frequency Oscillator.
Range: 0.010Hz – 4.800Hz, or 1/16 (4 whole notes) to 16 (64th note) if Tempo Sync is enabled

D. LFO Depth

This adjusts the magnitude of the LFO modulation. When set to 0%, the LFO has no effect on the notch frequencies.

Range: 0 – 100%

E. LFO Shape

This selects between the two LFO shapes.

Range: sine wave, triangle wave

F. LFO Tempo Sync

This selects whether the LFO rate is synchronized to the MINIAK's tempo. When "follow tempo" is selected, the LFO Rate parameter is displayed as a multiple of the Tempo.

Range: fixed rate, follow tempo

Theta Flanger: The Theta Flanger is a combination of phaser and flanger effects. The input is filtered through a 32-stage phaser, and then fed to the input of a flanger. The sound is very interesting and musical.

A. Feedback

This is the amount of the flanger output added back into the input to produce a deeper effect.

Range: -100% to 0 to +100%

B. Manual Delay

This is the base delay time that is modulated by the LFO to create the Flange effect. It determines the frequencies of the notches and peaks.

Range: 0 – 100%

C. LFO Rate

This is the rate of the Low Frequency Oscillator.

Range: 0.010Hz – 4.800Hz, or 1/16 (4 whole notes) to 16 (64th note) if Tempo Sync is enabled

D. LFO Depth

This adjusts the magnitude of the LFO modulation. When set to 0%, the LFO has no effect on the notch frequencies.

Range: 0 – 100%

E. LFO Shape

This selects between the two LFO shapes.

Range: sine wave, triangle wave

F. LFO Tempo Sync

This selects whether the LFO rate is synchronized to the MINIAK's tempo. When "follow tempo" is selected, the LFO Rate parameter is displayed as a multiple of the Tempo.

Range: fixed rate, follow tempo

Thru Zero Flanger: A Flange effect using two delay lines (per stereo side) to emulate the classic flange effect produced using two analog tape machines. Because there are two delay lines in constant motion, the delay time can fall through zero to become negative. This has a unique sound that can't be replicated with a standard, single-delay flanger.

A. Feedback

This is the amount of the flanger output added back into the input to produce a deeper effect.

Range: -100% to 0 to +100%

B. Manual Delay

This is the base delay time that is modulated by the LFO to create the Flange effect. It determines the frequencies of the notches and peaks.

Range: 0 – 100%

C. LFO Rate

This is the rate of the Low Frequency Oscillator.

Range: 0.010Hz – 4.800Hz, or 1/16 (4 whole notes) to 16 (64th note) if Tempo Sync is enabled

D. LFO Depth

This adjusts the magnitude of the LFO modulation. When set to 0%, the LFO has no effect on the notch frequencies.

Range: 0 – 100%

E. LFO Shape

This selects between the two LFO shapes.

Range: sine wave, triangle wave

F. Tempo Sync

This selects whether the LFO rate is synchronized to the MINIAK's tempo. When "follow tempo" is selected, the LFO Rate parameter is displayed as a multiple of the Tempo.

Range: fixed rate, follow tempo

Super Phaser: The classic phaser effect is created by ganging multiple all-pass filter stages to create "notches," or sharp dips in the frequency spectrum. The frequencies of these all-pass filters are usually modulated by an LFO to create a dramatic sweeping sound. The Super Phaser follows this classic formula but allows you to select from 4 to 64 all-pass stages for a wide variety of timbres.

A. Feedback

This is the amount of the phaser output added back into the input to produce a deeper effect.

Range: -100% to 0 to +100%

B. Notch Frequency

This is the frequency of the first (lowest) notch, un-modulated by the LFO.

Range: 0 – 100%

C. LFO Rate

This is the rate of the Low Frequency Oscillator.

Range: 0.010Hz – 4.800Hz, or 1/16 (4 whole notes) to 16 (64th note) if Tempo Sync is enabled

D. LFO Depth

This adjusts the magnitude of the LFO modulation. When set to 0%, the LFO has no effect on the notch frequencies.

Range: 0 – 100%

E. LFO Shape

This selects between the two LFO shapes.

Range: sine wave, triangle wave

F. Stages

This selects how many all-pass filter stages, and thus notches are used.

Range: 4, 8, 16, 32, 48, 64

G. Tempo Sync

This selects whether the LFO rate is synchronized to the MINIAK's tempo. When "follow tempo" is selected, the LFO Rate parameter is displayed as a multiple of the Tempo.

Range: fixed rate, follow tempo

String Phaser: This effect is based on the phaser built into a classic analog string synthesizer. It has 14 stages, and uses combination of positive and negative feedback to produce a rich and complex sound.

A. Feedback

This is the amount of the phaser output added back into the input to produce a deeper effect.

Range: 0 - 100%

B. Notch Frequency

This is the frequency of the first (lowest) notch, un-modulated by the LFO.

Range: 0 – 100%

C. LFO Rate

This is the rate of the Low Frequency Oscillator.

Range: 0.010Hz – 4.800Hz, or 1/16 (4 whole notes) to 16 (64th note) if Tempo Sync is enabled

D. LFO Depth

This adjusts the magnitude of the LFO modulation. When set to 0%, the LFO has no effect on the notch frequencies.

Range: 0 – 100%

E. LFO Shape

This selects between the two LFO shapes.

Range: sine wave, triangle wave

F. Tempo Sync

This selects whether the LFO rate is synchronized to the MINIAK's tempo. When "follow tempo" is selected, the LFO Rate parameter is displayed as a multiple of the Tempo.

Range: fixed rate, follow tempo

40-band vocoder: A vocoder uses two sets of band-pass filters (filter banks) to impart the characteristics of one sound source onto another. The analysis filter bank determines the level of the input at several different frequencies. These levels are used to modulate the output levels of the corresponding frequencies of the synthesis filter bank. The most common use of this is to send a synthesizer signal into the synthesis input and a voice (recorded or live via a microphone) into the analysis input to get a "talking synthesizer" effect.

A. Analysis Gain

Also sometimes referred to as "Analysis Sensitivity," this adjusts the gain of the input to the analysis filter bank.

Range: -100% - +100%

B. Sibilance Boost

This adjusts the level of a high-pass shelving filter at the input to the analysis filter bank. This will increase or decrease the sibilant frequencies (consonant sounds) to improve intelligibility or change the tonality of the vocoder.

Range: 0% - 100%

C. Decay

This adjusts how quickly the synthesis filters will react to the input signal. A faster response (lower setting) will usually be more intelligible, but slower decay times (higher setting) can be more musical.

Range: 0 - 100%

D. Band Shift

This shifts the frequencies of the Synthesis filter bank, relative to the analysis filters. The result is a pseudo pitch-shift effect.

Range: -100% - +100%

E. Synthesis Input

This selects which signal is sent to the synthesis filter bank.

Range: Effects Send, Audio In Left, Audio In Stereo

F. Analysis Signal In

This selects which signal is sent to the analysis filter bank.

Range: Effects Send, Audio In Right, Audio In Stereo

G. Analysis Mix

This adjusts how much of the analysis signal is mixed into the output.

Range: 0 - 100%

FX2 EFFECTS

You may choose any one of the Effects 2 module's six different delay and reverberation effects.

Mono Delay: Delay takes the original signal, waits a specified period of time, and then plays it back, over and over.

Mono delay sums the MINIAK's input to mono before applying the delay effect. The result is a less complex but more "focused" sound.

Mono delay allows for a maximum delay time that is twice as long as that used by stereo delay and L/R delay.

A. Delay Time

This is the amount of time that the delay waits before regenerating the sound.

Range: 1 ms – 680 ms, or x1 (quarter note) – x16 (64th note) when Sync is set to "follow tempo"

B. Regeneration Percentage

This is the volume of every regeneration relative to the volume of the regeneration that preceded it. At zero, a "slapback" effect occurs—the original signal is repeated just once.

Range: 0 – 100%

C. Brightness

As the delayed signal decays over time, it is often advantageous to "darken" the sound by progressively removing more and more high frequencies with each regeneration. 100% represents no reduction in brightness.

Range: 0 – 100%

D. Sync

The delay can either follow the MINIAK's tempo or can occur according to a fixed number of milliseconds. When "follow tempo" is selected, the Delay Time parameter is displayed as a multiple of the Tempo.

Range: fixed time, follow tempo

Stereo Delay: Stereo delay operates similarly to Mono delay only in true stereo. The maximum delay time is half that available to Mono delay.

A. Delay Time

This is the amount of time that the delay waits before regenerating the sound.

Range: 1 ms – 340 ms, or x1 (quarter note) – x16 (64th note) when Sync is set to "follow tempo"

Note: Quarter note delays at 120 BPM (or slower) cannot be heard because the delay is greater than 340 ms.

B. Regeneration Percentage

This is the volume of every regeneration relative to the volume of the regeneration that preceded it. At zero, a "slapback" effect occurs—the original signal is repeated just once.

Range: 0 – 100%

C. Brightness

As the delayed signal decays over time, it is often advantageous to "darken" the sound by progressively removing more and more high frequencies with each regeneration. 100% represents no reduction in brightness.

Range: 0 – 100%

D. Sync

The delay can either follow the MINIAK's tempo or can occur according to a fixed number of milliseconds. When "follow tempo" is selected, the Delay Time parameter is displayed as a multiple of the Tempo.

Range: fixed time, follow tempo

Split Left/Right Delay: This stereo delay allows you to set the left and right delay times independently. Unlike the other delays, it does not allow for tempo synchronization.

A. Left Delay Time

This is the amount of time that the left-channel delay waits before regenerating the sound.
Range: 1 ms – 340 ms

B. Regeneration Percentage

This is the volume of every regeneration relative to the volume of the regeneration that preceded it. At zero, a "slapback" effect occurs—the original signal is repeated just once.
Range: 0 – 100%

C. Brightness

As the delayed signal decays over time, it is often advantageous to "darken" the sound by progressively removing more and more high frequencies with each regeneration. 100% represents no reduction in brightness.
Range: 0 – 100%

D. Right Delay Time

This is the amount of time that the right-channel delay waits before regenerating the sound.
Range: 1 ms – 340 ms

Hall Reverb: Reverberation simulates acoustic spaces, providing a dense set of echoes similar to those generated by a room's walls, floor, and ceiling.

Hall reverb simulates the reverb of a concert hall (which you can think of as an extremely large room).

A. Diffusion

The higher the diffusion, the more "washy" and indistinct the reverberated sound will be.
Range: 0 – 100%

B. Decay

This percentage represents how quickly the reverb decays over time. Lower values equate to faster decay.
Range: 0 – 100%

C. Brightness

As the reverberation decays over time, it is often advantageous to "darken" the sound by progressively removing more and more high frequencies with each regeneration. 100% represents no reduction in brightness.
Range: 0 – 100%

D. Color

This parameter adds harmonic content for a richer sound.
Range: 1 ms – 340 ms

Plate Reverb: This reverb algorithm mimics the behavior of plate reverb units. A plate reverb is a large (roughly 3 foot x 6 foot) and thin (roughly 1/64th inch) steel sheet, with a driver attached at its center to vibrate it and contact microphones attached further away to pick up the resulting vibration.

Plate reverb is the classic reverb sound heard on recordings up until the early 1980's, when digital reverbs hit the scene.

The parameters for the plate reverb are the same as those for the hall reverb.

Room Reverb: This reverb is very much like hall reverb, but it emulates a smaller space.

Again, the parameters for this reverb are identical to those for the hall and plate reverbs.

11. Envelopes

For each of the three envelopes, set the attack time and slope (**Atk**), the decay time and slope (**Dcy**), the sustain time and level (**Sust**), and the release time and slope (**Rel**).

The *sustain time* parameter determines the length of the sustain stage of the envelope. If you are familiar with analog synths, this parameter may surprise you, since a traditional synth will remain in the sustain stage as long as you have the note held down. The MINIAK provides this behavior, of course – simply set this parameter to "hold", and your note will be sustained until your finger gets tired. But many physical instruments do not work like this. A piano, for example, exhibits a distinct attack and decay as the hammer strikes the string, but the string does not then ring forever—the volume slowly diminishes until the string is silent. The MINIAK allows you to model this behavior by specifying a sustain time. This is the amount of time it takes for the envelope level to drop from the sustain level to zero. Once the envelope has sustained to zero, the envelope has completed and will remain at zero. When the amp envelope has sustained to zero, that means the entire note has completed and will no longer use one of the synth's voices.

The *sustain level* parameter specifies the level that the sound settles into as the envelope completes its decay and moves into the sustain stage. At 100%, decay becomes inaudible. At 0%, the decay becomes complete, resulting in silence. Generally, values in the middle of the range are most useful.

For the filter and pitch/mod envelopes, this parameter can be negative. Since the subsequent envelope stages always head back towards zero, a negative sustain level will give you an envelope that zigs high, zags low, and ends up somewhere in the middle.

Here are the additional envelope parameters:

Velocity (Keyboard Velocity Tracking): This parameter determines the extent to which the note velocity, or how hard you hit the key, affects the envelope. When set to 0%, the envelope always comes out full-strength, regardless of how lightly you hit the key. When set to 100%, the amplitude of the envelope directly matches the velocity, and very light keystrokes will result in very weak envelopes. Parameter values in the middle scale accordingly.

In all cases, a hard keystroke produces a strong envelope. This parameter just lets you choose the envelope strength for weak keystrokes.

Reset

on every note
Whenever you press a key, the envelope starts at the beginning.

unless legato
If you play one note while holding down another, the new note's envelope starts at the current position of the held note.

Freerun: This parameter determines the how the envelope treats its sustain portion. If set to off, then the envelope transitions from the attack stage to the decay stage to the sustain stage, as long as you are holding the key down. As soon as you take your finger off the key, the envelope will move into the release stage.

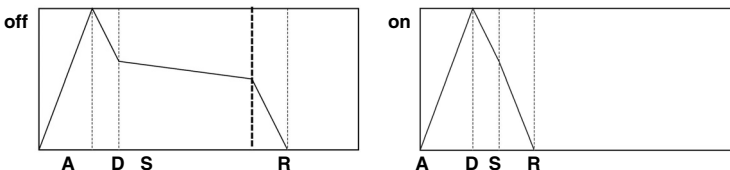

Envelope types

"Env1" is the Amplitude envelope.

"Env2" is the Filter envelope.

"Env3" is the Pitch/Modulation envelope, though its assignment can vary. All envelopes can be used to modulate any parameter in the modulation matrix.

Quick access to editing

To jump to the envelopes category, hold down the [PROGRAMS] button and press the key labeled "env."

Mapping the (X/Y/Z) knobs

Remember, any parameter may be mapped to the x, y, or z knobs. When the parameter is on the screen, simply hold down the DATA DIAL and wiggle the knob that you want to map to.

If this parameter is set to on, then there is no sustain stage — the envelope transitions from attack to decay to release. Furthermore, it doesn't matter how long you hold down the key; the envelope always follows this fixed-length program.

If you are using the Loop feature of the envelope, this parameter will have further effects on the envelope behavior, and these will be discussed below.

Loop: These settings determine how the envelope is used when notes are held down (sustained).

off

The envelope acts normally. (When the end of the envelope is reached, the note stops playing.)

attack/decay

The envelope loops through the attack and decay stages. (If Freerun is on, the envelope will even continue looping after you release the note. You will usually only want to use this configuration with your filter or pitch/mod envelopes. If you set up the amp envelope to loop forever, you'll only be able to stop it by playing a lot of other notes at once to steal the voice.)

entire envelope

The envelope loops through the entire envelope. As in attack/decay, if Freerun is on, the envelope will continue looping after you release the note.

while note held

The envelope loops through the attack and decay stages, but only while the note is held down, regardless of the Freerun setting.

Sus Pedal (Sustain Pedal)

on

The MINIAK treats the sustain pedal as if you are holding notes down on the keyboard, keeping notes within the sustain section of the envelope as long as the sustain pedal is held down.

off

The MINIAK ignores the sustain pedal relative to the envelope. The envelope goes into the release stage when the note is released.

12. Low Frequency Oscillator (LFO) settings

TempoSync (Tempo Synchronization)

fixed rate

The LFO rate is independent of the tempo set with the **[TAP TEMPO]** button.

follow tempo

The LFO's rate is a multiple of the tempo set with the **[TAP TEMPO]** button.

If **TempoSync** is *off*, the rate is adjustable from 0.010 – 1000 Hz (cycles per second).

If **TempoSync** is *on*, the rate represents a fraction of the tempo set with the **[TAP TEMPO]** button. When the value is set to $x\ 1$ ("times one"), the LFO will complete its cycle once per quarter note, relative to the tempo setting. When the value is set to $x\ 2$, the LFO will cycle once per eighth note. A value of $x\ 16$ results in an LFO cycle of 1/64th note, and a value of $x\ 1/16$ results in an LFO cycle equivalent to sixteen quarter notes.

Quick access to editing

To jump to the Low Frequency Oscillator category, hold down the **[PROGRAMS]** button and press the key labeled "LFO."

It's bipolar.

Synthesizer LFOs can be either "unipolar" (rising and falling in the ≥ 0 range) or "bipolar" (rising and falling through both positive and negative values).

The MINIAK's LFOs are bipolar. You can make them act like unipolar designs by programming a counteracting positive offset in the modulation matrix. (Just don't change the LFO modulation amount once you've done this, or your offset won't be accurate anymore.)

Reset

mono

The LFO is shared between the voices of a Program. It may be at any point in its cycle when the first key is pressed. New voices will "ride" that LFO, joining other voices at the exact same point in the LFO's cycle. The LFOs in each Program are independent of each other, so they can be running at different speeds.

poly

Each voice's LFO is completely independent of the others. When a key is pressed, that voice's LFO may be at the top of its cycle, at the bottom, or anywhere else in the cycle when it begins to affect the voice.

key-mono

The LFO is shared between the voices of a Program. When the first key is pressed, the LFO's cycle resets to the beginning. When a second key is pressed, the LFO will reset its cycle to the beginning and start over.

key-poly

Each voice has its own LFO that resets when the voice is triggered.

tempo lock

The LFO resets when the master tempo clock hits the "1," as long as TempoSync is set to "follow tempo".

MOD1 wheel

To place the LFO's amplitude under the total control of the **(MOD1)** wheel, set this value to 100%. To ignore the **(MOD1)** wheel altogether, set the value to 0%. Values in between allow for limited **(MOD1)** control over the LFO.

13. Sample-and-Hold (S&H) settings

The first three settings – **TempoSync**, **Rate**, and **Reset** – operate identically to the LFO settings listed above. Here are the additional S&H settings:

Input

The Input to the Sample & Hold determines the source of the S&H values. If the source is continuously active, like an LFO, there will be an endless supply of new values for the Sample & Hold to feed to its destination in the mod matrix. If the source is something more static like one of the wheels or pedals, the destination will receive new values from the Sample & Hold only after the value of the input is changed and another sample is taken.

The inputs for the S&H generator are the same as the Modulation Matrix's modulation sources (discussed later).

Smoothing

This parameter governs the abruptness of the shift from the value of one sample to the value of the next. A low smoothing value causes the sample values to change instantly from one value to the next when the new sample is taken. A high smoothing value causes the Sample & Hold to "slide" from one value to the next.

*Remember that it is possible to have the LFOs set independently, so that one LFO's Reset parameter may be set to **poly**, for example, while the other's is set to **key-mono**.*

Synchronizing the LFO's to your Sequences and Rhythms

If you want your LFOs to sync up with your Sequences and Rhythms, set TempoSync to "follow tempo", and set Reset to "tempo lock".

Why is my LFO not working?

*If you routed an LFO to a destination in the mod matrix, but it doesn't seem to have any effect, check the "MOD1 wheel" parameter. If this parameter is set to 100%, then the LFO will only be active if the **(MOD1)** wheel is up. If you want the LFO to always be active, set this parameter to 0%.*

What does Sample & Hold mean?:

Sample & Hold is a term that originated in the early days of analog modular synthesizers. It describes the process by which a reading, or "Sample," is taken at regular intervals of a particular input source, such as an LFO. That Sample becomes a value that is fed to a destination, such as filter frequency. The destination parameter is held at this value until the "Hold" period has expired, at which time another Sample of the input source is taken and fed to the destination, and so on.

S&H Smoothing: *With Sample & Hold smoothing set to very high values, it is possible that very little or no change may be heard at the destination. If you're not hearing the desired amount of S&H, try decreasing the smoothing value.*

14. Track (Tracking Generator)

The tracking generator lets you create your own curves for the modulation sources. This allows for non-linear effects. For instance, as a source increases in amplitude, the destination can be affected first negatively, then positively, and then negatively again.

Quick access to editing

To jump to the tracking generator category, hold down the **[PROGRAMS]** button and press the key labeled "track."

The inputs for the tracking generator—like those for the S&H generator—are the same as the Modulation Matrix's modulation sources (discussed later).

Grid: The input to the Tracking Generator is quantized to either 12 or 16 points above and below 0.

Point x: After you've created your grid, you can cycle through each point and set its value from -100% to +100%.

An example should help clarify the concept:



At the left, 16 points are indicated. This is the number of positive points. There are 32 points total, if you count the negative ones. Indeed, the display shows 32 points – 16 each to the left and right of the y axis.

Now, what's displayed is a pretty radical tracking generation. As you can see, before the midpoint of this source's range, increasing values are intercepted by the tracking generator and turned into wildly non-linear, unexpected results. When the midpoint is reached, the tracking generator locks the source's output at 0 (its middle range). Then, at the eighth positive point, the tracking generator gradually ramps up the source's output value. It holds steady for a while and then begins a gradual descent at the fourteenth positive point. How does all this sound? Pretty weird.

Remember, without the tracking generator, the source's output would function normally – you'd see a diagonal line rising from the bottom left to the top right, without interruption. The purpose of the tracking generator is to intercept and regenerate that line.

15. Mod (Modulation Routing)

For each of the twelve possible modulation routes, set the source, the destination, the level, and the offset.

Quick access to editing

To jump to the modulation routing category, hold down the **[PROGRAMS]** button and press the key labeled "mod."

The *level* determines the extent to which the source will affect the destination.

The *offset* changes the destination's value before the modulation begins.

After the last modulation route, you can add a new route, up to the maximum twelve routes.

To remove a mod route, double-click on "Dest." The MINIAK will ask, "Remove mod?" Push the **DATA DIAL** to confirm.

Mod sources

Here are the inputs to the modulation matrix:

SOURCE	DESCRIPTION
(none)	No effect
Aftertch	Polyphonic (per-note) Aftertouch, MIDI only
Env 1	Amp Envelope Level
Env 2	Filter Envelope Level
Env 3	Pitch/Modulation Envelope Level
ExpPedal	Position value of Exp pedal, or incoming MIDI CC as assigned
Keytrack	MIDI Key # used as modulator. MIDI note #60 is equivalent to 0.
KeytrackXt	Same as Key Track but with the output multiplied by four.
LFO1 Saw	LFO 1 Saw wave output
LFO1CSaw	LFO 1 Saw wave output, phase shifted 90 degrees
LFO1 Sin	LFO 1 Sine wave output
LFO1CSin	LFO 1 Sine wave output, phase shifted 90 degrees
LFO1 Sqr	LFO 1 Square wave output
LFO1CSqr	LFO 1 Square wave output, phase shifted 90 degrees
LFO1 Tri	LFO 1 Triangle wave output
LFO1CTri	LFO 1 Triangle wave output, phase shifted 90 degrees
LFO2 Saw	LFO 2 Saw wave output
LFO2CSaw	LFO 2 Saw wave output, phase shifted 90 degrees
LFO2 Sin	LFO 2 Sine wave output
LFO2CSin	LFO 2 Sine wave output, phase shifted 90 degrees
LFO2 Sqr	LFO 2 Square wave output
LFO2CSqr	LFO 2 Square wave output, phase shifted 90 degrees
LFO2 Tri	LFO 2 Triangle wave output
LFO2CTri	LFO 2 Triangle wave output, phase shifted 90 degrees
MOD1Wheel	Position Value of (MOD1) wheel, or incoming MIDI CC#00 message.
MOD2Wheel	Position value of (MOD2) wheel, or incoming MIDI channel pressure message
P Wheel	Position value of Pitch wheel, or incoming MIDI Pitch Bend messages
PortaEfx	Portamento Level scaled by keyboard position, so that the modulation level follows the note's pitch.
PortaLvl	Level of Portamento output, as a percentage of the "glide" travel from starting note to ending note.
Pressure	Monophonic (per-MIDI Channel) Aftertouch, MIDI only
RndmGlbl	Random modulation source, common to all voices
RndmVoic	Random modulation source, unique to each voice
S/H	Output of the Sample and Hold processor
SusPedal	Position (Up/Down) of Sustain pedal, or incoming MIDI CC#64 messages
Track	Output of Tracking Generator, Interpolated
TrackStp	Output of Tracking Generator, Stepped
Velocity	Velocity (how hard) the key is struck
VelociUp	Velocity that the key is released.
CC 1...119	Value of incoming MIDI Continuous Controller messages

Mod destinations

Here are the possible destinations for the modulation matrix:

DESTINATION	DESCRIPTION
Ptch	Modulates pitch of all three oscillators through entire 10 octave range
PtchNar	Modulates pitch of all three oscillators, constrained to 1 octave
FM Amnt	See equivalent Program Parameter
Osc1Pit	Modulates oscillator 1 pitch through entire 10 octave range
Osc1Nar	Modulates oscillator 1 pitch, constrained to 1 octave
Osc1Shp	Modulates oscillator 1 shape
Osc2Pit	Modulates oscillator 2 pitch through entire 10 octave range
Osc2Nar	Modulates oscillator 2 pitch, constrained to 1 octave
Osc2Shp	Modulates oscillator 2 shape
Osc3Pit	Modulates oscillator 3 pitch through entire 10 octave range
Osc3Nar	Modulates oscillator 3 pitch, constrained to 1 octave
Osc3Shp	Modulates oscillator 3 shape
Osc1Lvl	
Osc2Lvl	
Osc3Lvl	
RingLvl	
NoisLvl	
ExInLvl	
Osc1Bal	
Osc2Bal	
Osc3Bal	
RingBal	
NoisBal	
ExInBal	
F1F2Lvl	
PortaTm	
UnsnDtn	
Flt1Frq	
Flt1Res	
Flt1Env	
Flt1Ktk	
Flt2Frq	
Flt2Res	
Flt2Env	
Flt2Ktk	
Flt1Lvl	
Flt2Lvl	
PfltLvl	
Flt1Pan	See equivalent Program Parameters
Flt2Pan	
PfltPan	
DrivLvl	
PgmLvl	Program output level
Pan	
FxMix	Effects amount
Fx1 A	
Fx1 B	See equivalent Effect parameters
Fx1 C	
Fx1 D	

Env1Amp	Scales the amplitude of the envelope's output - thus affecting the amount that the envelope modulates anything else.
Env1Rat	Modulates all of the envelope time stages - Attack, Decay, Sustain and Release - simultaneously.
Env1Atk	See equivalent Program Parameters
Env1Dcy	
Env1STm	
Env1SLv	
Env1Rel	
Env2Amp	Scales the amplitude of the envelope's output - thus affecting the amount that the envelope modulates anything else.
Env2Rat	Modulates all of the envelope time stages - Attack, Decay, Sustain and Release - simultaneously.
Env2Atk	See equivalent Program Parameters
Env2Dcy	
Env2STm	
Env2SLv	
Env2Rel	
Env3Amp	Scales the amplitude of the envelope's output - thus affecting the amount that the envelope modulates anything else.
Env3Rat	Modulates all of the envelope time stages - Attack, Decay, Sustain and Release - simultaneously.
Env3Atk	See equivalent Program Parameters
Env3Dcy	
Env3STm	
Env3SLv	
Env3Rel	
LFO1Rat	See equivalent Part parameters
LFO1Amp	Scales the amplitude of LFO 1's output - thus affecting the amount that the LFO can modulate anything else.
LFO2Rat	See equivalent Program Parameter
LFO2Amp	Scales the amplitude of LFO 2's output - thus affecting the amount that the LFO can modulate anything else.
S/H Rat	See equivalent Program Parameter
S/H Sm	
S/H Amp	Scales the amplitude of the S&H output - thus affecting the amount that the S&H can modulate anything else.

16. Category

Place the Program in one of the MINIAK's pre-defined categories.

17. Program name

Since Programs are listed alphabetically, creative naming can help you move smoothly from one Program to another.

Turn the **DATA DIAL** to select a position (1 – 14) to edit. Then press the **DATA DIAL** to edit that position. Edit either by turning the **DATA DIAL** or pressing notes on the keyboard.

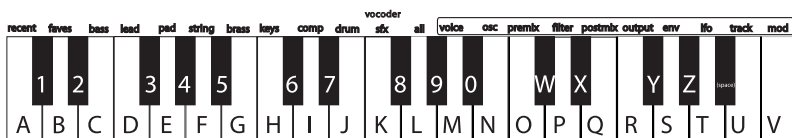

Press a key twice to toggle between upper and lower case.

Inserting and deleting characters: To insert a space in the name, navigate to the position at which you want to add the space. Hold down the **DATA DIAL** and turn it clockwise. To delete a character, navigate past it, hold down the **DATA DIAL**, and turn it counterclockwise. (In both cases, imagine that you are "dragging" the name around.)

18. Delete?

Delete the Program using this function, if desired.

19. Send MIDI sysex?

Choose this option to send the Sequence to a computer or other MIDI storage device using the MINIAK's (MIDI OUT) port.

This allows you to back up your Sequences to your computer, or share them with others. (See Chapter 8 for details on what Sysex is and how to use it.)

20. Store a copy?

Unlike many synths, the MINIAK does not have fixed "banks" of Programs, Sequences, and so on, each with a predetermined number of storage locations. Instead, you may freely create and delete Programs at any time, just as you would on a computer.

"Store a copy?" is how you create a new Program. This option creates a brand new copy of the current Program, differing only in name. Now, when you make changes and hit the **[STORE]** button, you will be storing to this new copy.

Whenever you want to start a new Program from scratch, you will have to find an existing Program to base it off of, and then store a copy. Don't forget to store a copy, or you might accidentally overwrite the original Program.

Store your changes!

Be sure to press the **[STORE]** button after you're satisfied with your changes. Otherwise, your changes will be lost when the MINIAK is turned off.

However, keep in mind that you don't lose any changes when you switch to other modes, so feel free to browse through Sequences or Multis without storing your Program. Additionally, if you play a Multi that uses the current Program, you'll hear your edited version, even without storing. This is a great way of checking how your edits sound in the context of a Multi, without having to commit to them.

You can even play other Programs without losing your edits. Just hit the **[PROGRAMS]** button and turn the **DATA DIAL**. You can always come back to your edited Program, just as you left it. The MINIAK doesn't discard your edits until you start editing a different Program.

Exiting Program editing

You can exit Program editing at any time. Simply press any of the buttons encircling the **DATA DIAL**, including the **[PROGRAMS]** button a second time.

CHAPTER 7: CONFIGURATION

[CONFIG]

Press [CONFIG] to set the MINIAK's global configuration options. [CONFIG] only glows red.

CONFIGURATION PARAMETERS

1. Contrast: Adjust the LCD screen's contrast.

If you happen to turn on your MINIAK and the screen is blank, it's possible that your contrast setting was somehow turned down. Since contrast is the first of the config options, you should be able to get to it even when navigating blindly. Simply hit the [CONFIG] button, and double-click the DATA DIAL.

Double-click to restore defaults
Configuration options can be reset by pressing the DATA DIAL twice quickly (double-clicking).

2. Tuning: Adjust the MINIAK's global tuning over a plus or minus 200 cent range. One cent is equal to 1/100th of a semitone, so this means that the global tuning can be raised or lowered by up to a whole step.

The MINIAK's default tuning is set to A=440 Hertz.

3. Transpose: Shift the placement of the MINIAK's keyboard with respect to the 128-note MIDI key range. By default, the MINIAK's keyboard spans from C4 to C7; this option lets you offset that. You can also use the [OCTAVE] buttons to quickly transpose up and down by octaves.

This option does not affect how incoming MIDI notes are interpreted.

4. Velocity Curve: Edit the keyboard's response to your playing velocity. This option affects the velocity values that are generated when you play the keyboard; it has no effect on incoming MIDI notes.

Options are linear low, medium and high; exponential low, medium and high; and logarithmic low, medium and high.

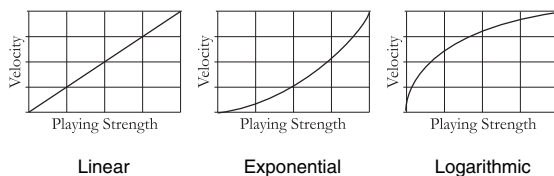

Press the DATA DIAL to edit the velocity curve. Turn the DATA DIAL to select a new curve. Press the DATA DIAL again to accept the curve setting and return to the main config menu.

5. Local Control: Turn the DATA DIAL clockwise once to edit the keyboard's local control setting. Options are "on," "off," or "off + send ptns." By default, local control is set to "on." Set to "on," the MINIAK functions normally – the keyboard, wheels, footswitches, and pedal all play the MINIAK.

Setting local control to "off" disconnects the MINIAK's sound engine from all of these controllers. Leave local control "on" in most situations. There are three main exceptions:

a. External Sequencers: Consider turning local control "off" when you use MIDI cables to connect the MINIAK to an external sequencer, such as a computer-based or standalone Digital Audio Workstation. When you record with a sequencer, usually that sequencer "echoes" back whatever you play into it. So, if you leave local control on, everything you do play will trigger twice—once as a result of your playing, and once as the sequencer replays what you've just played. This is generally undesirable.

b. Using the MINIAK within a multi-controller Multi: Imagine a saxophonist who wants to control the MINIAK with a MIDI wind controller. At the same time, the saxophonist has a rack-mounted sound module that she wants to control using the MINIAK keyboard. Setting local control off makes sense in this case, too, as playing the wind controller will trigger the MINIAK, and playing the MINIAK will trigger the sound module.

c. Using the MINIAK with a MIDI patch bay: If you employ a MIDI patch bay to route controllers and sound sources, you will probably want to set local control to off.

The MINIAK also has a special "off + send ptns" mode which actually sends out complete Sequence data (all notes, velocities, control change information) rather than one simple command to start and stop a stored Sequence within the MINIAK. Some users may find this useful if they want to record their Sequences within a computer sequencer.

6. MIDI Setup Mode: MIDI mode options are "single-channel" or "multi-channel." This setting affects Multis. In "single-channel" mode, the MINIAK only sends and receives MIDI data over one of the 16 possible MIDI channels. In "multi-channel" mode, each part and beat sends and receives MIDI data on a separate channel.

Turn the **DATA DIAL** to select either "single-channel" or "multi-channel."

7. MIDI channel: Your options will differ depending upon the setting chosen earlier in *MIDI mode*:

If the MINIAK is set to "single-channel" mode, you will be able to select the MIDI channel.

If the MINIAK is set to "multi-channel" mode, you will be able to select the MIDI channel for the first part. The channel for each additional part and beat will increment from there. (For instance, if you set the channel to "4," then Part A will use MIDI channel 4; Part B will use MIDI channel 5; etc.

Even in multi-channel mode, the MINIAK will never use a MIDI channel lower than the channel specified in this option, so you can assign the lower channels to other MIDI instruments.

Because there are only sixteen MIDI channels, a Multi with more than sixteen parts and beats will not work well in multi-channel mode. The parts that would be assigned channels above 16 will not send or receive MIDI data.

8. MIDI sync: The MIDI sync setting determines how incoming timing signals sent over MIDI are processed.

The default setting for MIDI sync is "off." In this mode, any incoming MIDI timing data is ignored. This allows you to set the MINIAK's tempo normally, using the **[TAP TEMPO]** button and the **DATA DIAL**.

Tempo gone haywire?

If your tempo seems to have a mind of its own, see whether MIDI sync is set to "ext MIDI sync." Set it to "off" or "gen MIDI clock" to rectify the situation.

When MIDI sync is set to "ext MIDI sync," the MINIAK accepts incoming tempo information from external MIDI devices such as sequencers. When it receives such information, the tempo from the external device controls the tempo setting in the MINIAK.

A third setting, "gen MIDI clock," generates tempo information and sends it out via the MINIAK's (**MIDI OUT**) port.

To summarize:

- **off:** the MINIAK sets its tempo independent of other devices.
- **ext MIDI sync:** incoming synchronization from other devices controls the MINIAK's tempo.
- **gen MIDI clock:** the MINIAK controls other devices' tempo.

9. Store Protect: By default, store protection is "on." When store protection is on, you cannot save or delete within the MINIAK. Once you feel comfortable saving changes, turn store protection "off."

10. Sysex: send all: Push the **DATA DIAL** to send a SysEx to a computer or other external device through the (**MIDI OUT**) port on the back of the MINIAK. This SysEx will contain everything you have stored on your MINIAK – every Program, Multi, Rhythm, and Sequence. This can be used to back up all of your data at once, or to share your entire collection with others.

CHAPTER 8: MIDI

WHAT IS MIDI?

MIDI is the communication standard for electronic musical instruments. You can use MIDI to:

- Record what you play on your MINI AK synthesizer into a sequencer or computer.
- Play back sequences from a sequencer or computer on your MINI AK.
- Store and recall Programs and Multis on a computer.
- Use a computer to edit your MINI AK's sounds.
- Use your MINI AK to control another synthesizer or sound module.
- Use another keyboard to play your MINI AK's sounds.

Some examples of MIDI devices besides your MINI AK synthesizer include keyboard controllers, sound modules, drum machines, sequencers, and computers with MIDI interfaces.

MIDI Connections

The MINI AK has three MIDI connectors:

- **(MIDI IN)** is for receiving MIDI information from another MIDI device.
- **(MIDI OUT)** is for sending MIDI information to another device.
- **(MIDI THRU)** echoes whatever is received on the **(MIDI IN)** port.

Here are four typical MIDI setups for your MINI AK, and the appropriate connections for each of them:

Controller.

With this setup, you can use your MINI AK to "play" another MIDI instrument (synthesizer, sound module, drum machine etc.). Connect a MIDI cable from the MINI AK's **(MIDI OUT)** jack to the MIDI IN of the device you want to control.

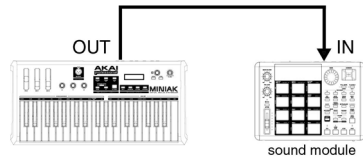

For this setup, ensure that the MINI AK's Local Control setting is ON (in the **[CONFIG]** settings).

Slave.

With this setup, you can use another keyboard to play the sounds on your MINI AK. Connect a MIDI cable from the controller's MIDI OUT jack to the MINI AK's **(MIDI IN)** jack.

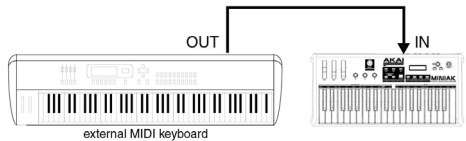

Slave with pass-through.

This setup allows MIDI signals to pass through the MINI AK so they may reach multiple units. This allows one MIDI device to control several. Attach a cable from the MIDI OUT of the first device to the **(MIDI IN)** jack of the MINI AK; and then attach another cable from the MINI AK's **(MIDI THRU)** jack to the MIDI IN of the third device.

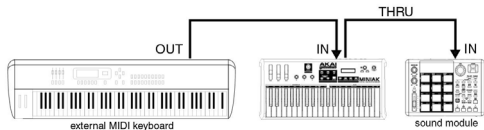

Sequencing.

This setup allows you to use your MINI AK with a MIDI sequencer or a computer with a MIDI interface. Attach one MIDI cable from the MIDI OUT of the sequencer or computer to the **(MIDI IN)** jack of the MINI AK. Attach another cable from the MINI AK's **(MIDI OUT)** jack to the MIDI IN of the sequencer or computer.

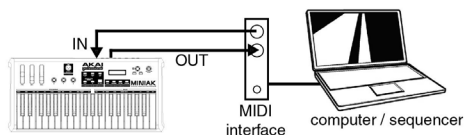

For this setup, switch the MINI AK's Local Control setting to OFF (in the **[CONFIG]** settings).

Saving Programs, Multis, Rhythms, and Sequences via MIDI System Exclusive

The MINIAK lets you transmit Programs, Multis, Rhythms, and Sequences to an external device (such as a computer, sequencer, storage device, or another MINIAK synthesizer) via MIDI. MIDI devices use a protocol called "System Exclusive" messaging (Sysex for short) for transmitting and receiving these communications. Use the Send Sysex and Send SysEx Bundle commands from within the **[PROGRAMS]**, **[MULTI]**, **[RHYTHMS]**, or **[SEQUENCES]** modes to send this information.

To save a SysEx on your computer, you can typically start your sequencer recording, send the SysEx from the MINIAK, and then save the MIDI file in your sequencer. Your sequencer may also have features for receiving and storing a "SysEx dump" directly. Consult your sequencer's reference manual.

Loading Programs, Rhythms, Sequences, and Multis via MIDI

The MINIAK doesn't need to be in a special mode to receive MIDI SysEx information. Simply connect a MIDI cable from the MIDI out jack of your MIDI player to the **(MIDI IN)** port of your MINIAK and start the SysEx dump on your MIDI storage device or computer. If everything is working properly, the MINIAK display will read "Receiving..." and the Program, Multi, Sequence, or Rhythm will be loaded.

***NOTE:** Some computers are not fast enough to transmit MIDI SysEx data properly. If you are experiencing problems, try adjusting the settings in your MIDI software. Some programs allow you to slow down the transmit rate so the computer hardware can keep up with the software.*

What's a bundle?

There are two options for sending a Multi, Rhythm, or Sequence: "Send MIDI sysex?" and "Send syx bundle?" The difference has to do with dependencies.

For example, a Multi can depend on Sequences and Rhythms that are stored on your MINIAK. If you send a Multi to a friend and his MINIAK doesn't have the Sequences and Rhythms that your Multi uses, the Multi might not sound the same. Similarly, Multis, Rhythms, and Sequences all depend on Programs. If your friend's MINIAK has a different set of Programs than yours, nothing you send him will sound the same.

To solve this problem, you can send a bundle. A SysEx bundle contains the Multi, Rhythm, or Sequence you are sending, plus everything it depends on – all of the Rhythms, Sequences, and Programs that your friend will need to hear your creation exactly as it sounds on your MINIAK.

Compatibility with other programs

The MINIAK's Programs are 100% compatible with the Alesis Ion and the Alesis Micron. However, the MINIAK's Sequences, Rhythms, and Multis are not compatible with the Ion.

Sharing Programs between the Akai MINIAK and the Alesis Ion or Micron

Sending Programs from the MINIAK to the Ion

Connect the MINIAK's **(MIDI OUT)** port to the Ion's or Micron's MIDI IN port. Send Programs using the Send SysEx screen from within the MINIAK's **[PROGRAMS]** mode.

Sending Programs from the Ion or Micron to the MINIAK

Connect the Ion's or Micron's MIDI OUT port to the MINIAK's **(MIDI IN)** port. Send Programs from the Ion or Micron as directed in the unit's reference manual.

Updating Software Via MIDI

The MINIAK's operating system software can be upgraded via MIDI. From time to time Akai may release updates, which will add or enhance features. Software updates will be posted to the Akai website. In order to upgrade the MINIAK's software, you will need a computer with a MIDI interface and MIDI sequencing software.

To Upgrade the Software in your MINIAK:

1. Connect the MIDI OUT of the computer to the **(MIDI IN)** of the MINIAK.
2. Open the ".syx" or ".mid" software file in your sequencer program.
3. Turn the MINIAK's power on while holding both the **[SEQUENCES]** and **[PROGRAMS]** buttons.
4. After briefly displaying the current operating system version, the display will read "Ready to receive OS through MIDI."
5. Play the ".syx" or ".mid" file.

All Notes Off

The MIDI command **All Notes Off** is used to silence a synthesizer with a note or notes that are stuck on. This is usually caused when a Note On message is received without a Note Off. Press the **[PROGRAMS]** button twice in quick succession to force all notes off.

FREQUENTLY ASKED QUESTIONS

There are category labels ("bass", "lead", "pad") above the keys. How do I use them?

Hold down **[PROGRAMS]** and press a key. Turn the **DATA DIAL** to hear other programs in the category.

There are Program parameter labels ("voice", "osc", "filter") above the keys. How do I use them?

Hold down **[PROGRAMS]** and press a key. Turn the **DATA DIAL** to see other parameters in the group.

How do I add a Program to the "faves" category?

1. Find the Program that you want to add, and push the **DATA DIAL**.
2. The display will say, "Add to faves?" Push the **DATA DIAL** again to do so.

How do I assign a Program parameter to one of the knobs?

1. Find the parameter that you want to assign, either by pressing **[PROGRAMS]** and pushing the **DATA DIAL**, or as described in the previous question.
2. Hold down the **DATA DIAL**, and wiggle the (**X/Y/Z**) knob that you want to assign it to.

How do I record a new Sequence?

1. Press **[SEQUENCES]**, and scroll all the way to the left, to "** Empty Sequence".
2. Push the **DATA DIAL**, scroll all the way to the right, and choose "Store a copy?"
3. Scroll left, to "Record Sequence?" You will hear the metronome start to click.
4. Jam!
5. Be sure to press the **[STORE]** button at some point to store your new Sequence.

You can change the Program that your Sequence uses by scrolling to "Sequence program", or holding **[PROGRAMS]** and pressing **[SEQUENCES]**. You will probably also want to give your Sequence a name at some point.

I was recording a Sequence and made a mistake. How do I clear the Sequence and start over?

Scroll to "Clear Sequence?" and press the **DATA DIAL**. Alternately, you can hold **[SEQUENCES]** and press the highest key on the keyboard to jump right there.

How do I split and layer the keyboard?

You need to create a Multi. MINIAK was designed to make splitting and layering as easy as possible. Follow this procedure:

1. Press **[PROGRAMS]**, and find a Program that you like.
2. Push the **DATA DIAL**, turn to "Start new Multi?" and push again.
3. Press **[PROGRAMS]**, and find another Program that you like.
4. Push the **DATA DIAL**, turn to "Send to Multi?" and push again.
5. Depending on what you want to do, turn to "Layer part A?", "Split A low?", or "Split A high?", and push again.
6. If you chose to split, you will be asked to select a split point.
7. Continue sending Programs to the Multi until you've created all the splits and layers you want.

How do I change the Program in a Multi Part?

There are three ways of doing this. Use whichever suits your taste:

- In Multi Mode, push the **DATA DIAL**, turn to "Part x program", and set it to the Program you want.
- Press **[PROGRAMS]** and find the Program you want. Push the **DATA DIAL**, choose "Send to Multi?", and choose "Send to part x?".
- Press **[PROGRAMS]** and find the Program you want. Hold down **[PROGRAMS]** and press **[MULTI]**. This sends the Program to the most recently viewed part.

All three of these methods work for Sequences and Rhythms as well.

How can I quickly see which Programs are in which Multi Parts?

Hold down **[MULTI]** and press keys, starting with the A above middle C (labeled "voice"). Pressing the A key will show you Part A, the B key will show Part B, and so on. To browse through Beats, go an octave higher. The highest A will show Beat A, and so on.

How do I add a Rhythm to my Multi?

The same way you add a Program or Sequence. But since you will often only have a single Beat in a Multi, the quickest way to add it or change it is to press **[RHYTHMS]**, find the Rhythm you want, and then simply hold **[RHYTHMS]** and press **[MULTI]** to send it over.

How do I assign different Programs to different MIDI channels, so I can play multiple Programs at once from my PC's sequencer?

You need to create a Multi. Follow this procedure:

1. Press **[PROGRAMS]**, and find a Program you like.
2. Push the **DATA DIAL**, turn to "Start new Multi?" and push again.
3. Press **[PROGRAMS]**, and find another program that you like.
4. Push the **DATA DIAL**, turn to "Send to Multi?" and push again.
5. Turn to "Add part B?" and push again.
6. Continue to add parts until the Multi contains all of the Programs you want.

You can now play these Programs from your sequencer. By default, Part A is on Channel 1, Part B is on Channel 2, and so on. If this doesn't seem to be working, see the next question.

How do I set which MIDI channels my MINIAK is using?

Press **[CONFIG]**, and scroll to the "MIDI: Channel" parameter. In Programs, Sequences, and Rhythms Modes, this is the only MIDI channel that the MINIAK will use.

In Multi Mode, you have a choice. If you want each Part and Beat to use a different channel, scroll to the previous parameter, "MIDI: Setup mode", and ensure that it is set to "multi-channel". This means that Part A will use the "MIDI: Channel" channel, Part B will use the next one, and so on. If you want the entire Multi to use just the single channel, set "MIDI: Setup mode" to "single-channel".

How can I select a Program/Multi/Sequence/Rhythm through MIDI?

First, you need the MIDI bank and patch numbers. For a Program, hold down the **[PROGRAMS]** button for a second, and these numbers will appear on the display. For a Multi, use the **[MULTI]** button, and so on.

Next, enter the bank and patch numbers into your sequencer. If this doesn't seem to work, you may need to check your sequencer's "bank select method". MINIAK uses the standard MIDI bank select protocol, wherein the bank number is equal to cc 32, plus 128 times cc 0. Other synths deviate from the standard, and your sequencer may be set up to accommodate them instead.

If it still doesn't work, see the next question.

Why isn't my MINIAK responding to MIDI program change messages?

Press **[CONFIG]**, scroll to the "MIDI: Pgm change" parameter, and ensure that it is set to "on".

How do I set the tempo?

There are three ways of doing this. Use whichever suits your taste.

- Tap the **[TAP TEMPO]** button to the beat (quarter-note intervals).
- Hold down the **[TAP TEMPO]** button and turn the **DATA DIAL** to set the tempo precisely.
- Connect your PC to your MINIAK via MIDI, and tell your PC's sequencer to send MIDI clock or MIDI timing messages. You can then set the tempo in your sequencer, and MINIAK will follow it. If this doesn't work, see the next question.

Why isn't my MINIAK syncing to MIDI clock?

Press **[CONFIG]**, scroll to the "MIDI: Sync" parameter, and ensure that it is set to "ext MIDI sync".

When I press [STORE], my MINIAK says, "Cannot store. Protection is on." How do I turn protection off?

Press **[CONFIG]**, scroll to the "Store: Protect" parameter, and change it to "off".

How can I compare my edited program (or Sequence, or Rhythm, or Multi) to what I last stored?

Push the **DATA DIAL**, and scroll all the way to the left, to "Revert to stored?" Push the **DATA DIAL** to play on the stored version. The display will now say, "Unrevert to edited?", so you can push the **DATA DIAL** again to go back to your edited version.

The [STORE] button is dimly lit. What does this mean?

This means that you have unstored work in some other mode. For example, if you are in Multi Mode and [STORE] is dim, then the current Multi has been stored, but perhaps there is a Program or Sequence with unstored changes. If your Multi uses this Program or Sequence, then you will even hear the changed version in your Multi. The dimly-lit button is a reminder to check the other modes before turning your MINI AK off.

How do I send the individual notes of a Sequence or Rhythm through MIDI?

Press [CONFIG], scroll to the "Kbd: Local control" parameter, and set it to "off + send Sequences".

A note is stuck on! How do I make my MINI AK turn it off?

Double-click the [PROGRAMS] button.

How do I use the vocoder?

Hold down the [PROGRAMS] button and press the key labeled "VOCODER / SFX". Select one of the Programs that contains the "#" symbol (which denotes vocoder Programs), plug a mic into the MIC INPUT, play the keyboard, and talk like a robot!

TROUBLESHOOTING

If you experience problems while operating your MINI AK, please use the following table to check for possible causes and solutions before contacting Akai customer service for assistance.

SYMPTOMS	CAUSE	SOLUTION
The display does not light up when the ON/OFF switch is turned on.	No power.	Check that the power adapter is plugged in properly.
No sound.	Bad Connections.	Check your audio cables; if necessary, swap cables.
	Volume is turned down.	Raise the Volume knob or Exp pedal.
	Local keyboard is disabled.	In the config menu, Set Local Control to "on."
	External MIDI device sent Volume (CC#7) or Expression (CC#11) commands with a value approaching 0.	Change Multis to revert to default values. Re-transmit higher values from MIDI device.
Notes sustain continuously.	Sustain pedal was plugged in after power was turned on.	Turn the unit's power off, wait a moment, and then turn it on again.
	Stuck notes due to incomplete MIDI data.	Press the [PROGRAMS] button twice in quick succession (double-click).
Notes played from MINI AK have a "doubled" or "flanged" sound	Local Control is set to "on," and MIDI echo/Thru is enabled on external MIDI device or computer.	In the config menu, Set Local Control to "off."
		Disable MIDI echo/Thru on external MIDI device.
Tempo cannot be controlled from within the MINI AK.	MIDI sync is set to "on."	In the config menu, Set MIDI sync to "off" or "gen MIDI clock." Alternatively, ensure that any external devices are not sending MIDI sync information to the MINI AK.
Cannot store and delete.	Write Protection is set to "on."	In the Config menu, turn "Protect" off.

Recovering from a Crash

If your MINIAK behaves erratically or "freezes" on you, turn it off, wait for a moment, and then turn it on again. Make sure you turn off any amplification first.

If your instrument still isn't working after that, then disconnect the **(MIDI IN)** cable and repeat the power on/off trick. This ought to work if your problem is being caused by strange MIDI data coming from an external MIDI device.

Checking the Software Version

To find out what version of the operating system software is currently installed in your MINIAK, hold down **[SEQUENCES]** and **[PROGRAMS]** while turning on the MINIAK. The current software version will display briefly. Then the MINIAK will indicate that it is ready to receive an operating system version over MIDI.

To return to normal operation, turn the MINIAK off and on again.

Restoring the Factory Defaults

You can restore the MINIAK to its factory default state at any time. Turn the MINIAK off. Then, hold down the **[PROGRAMS]**, **[MULTI]**, and **[OCTAVE DOWN]** buttons and turn the MINIAK back on again.

Cleaning Your MINIAK

Before doing cleaning of any kind, always disconnect the AC adapter.

For simple dusting and removal of minor dirt, wipe the instrument down with a slightly damp cloth.

For heavy dirt, use a non-abrasive household cleaner. Spray the cleanser onto a cloth, then use the cloth to clean the unit.

NEVER spray any cleaner directly onto the MINIAK — this can destroy the lubricants used in the switches and controls.

TECHNICAL SPECIFICATIONS

Synthesis:	Virtual analog (subtractive), noise generator, FM
Polyphony:	Up to 8 voices
Timbrality:	Up to 8 parts
Oscillators:	3 per voice with continuously variable waveshapes, sync, linear and exponential FM, Ring Mod, routable modulation matrix per voice
Filters:	2 multi-mode resonating filters per voice with 16 filter types
Modulation:	2 LFOs with multiple wave shapes, sample and hold, tracking generator, freely-routable modulation matrix per voice
Effects:	4 drive effects, 1 per part; master effects
Sequencing:	Step sequencer, arpeggiator, drum machine/rhythm sequencer, and phrase sequencer
Program memory:	Up to 1,000 Programs and multi-timbral Multis
Velocity sensitive:	Yes
Keyboard:	37-key, semi-weighted
External control:	MIDI in/out/thru
Inputs:	2 balanced 1/4" TRS, mic
Outputs:	2 balanced 1/4" TRS, 1/4" TRS headphone
Controls:	Pitch wheel, two assignable Q-Link modulation wheels, X, Y, and Z parameter knobs, pattern play, phrase arpeggiator, latch arpeggiator, keyboard octave, tap tempo, program controls, data push-knob, config, store, master volume
Pedal Inputs:	Assignable expression pedal, sustain pedal

AKAI
professional

WWW.AKAIPRO.COM