

ALESIS

— D R U M S —

PRIME Drum Module

User Guide



Table of Contents

(1.0) Introduction.....	5
(1.1) About this User Guide	5
(1.2) Box Contents	5
(1.3) Support.....	6
(1.4) Setup.....	6
(1.4.1) Connection Diagram.....	7
(2.0) Features	8
(2.1) Top Panel	8
(2.2) Rear Panel.....	12
(2.3) Front Panel.....	14
(2.4) Bottom Panel.....	14
(3.0) Operation	15
(3.1) Kit Mode	15
(3.1.1) Kit Piece Mode	17
(3.2) Browse Mode	19
(3.2.1) Browse Mode Functions.....	22
(3.3) Edit Mode.....	22

(3.4) Edit Mode Functions	28
(3.4.1) Changing Kit Pieces for a Trigger Slot	29
(3.4.2) Saving and Reverting Kits	30
(3.4.3) Class.....	30
(3.4.4) Library	30
(3.4.5) Favs.....	30
(3.4.6) Importing Samples.....	31
(3.5) Mix Mode.....	32
(3.5.1) Easy View.....	32
(3.5.2) Advanced View.....	33
(3.6) Jam Mode	42
(3.7) Trigger Mode	45
(3.7.1) Trigger Zones.....	48
(3.7.2) Crosstalk.....	48
(3.7.2.1) Learn XTalk	49
(3.7.3) Hi-Hat Setup	51
(3.7.4) Trigger Input Tweaks	52
(3.7.4.1) KD (Kick).....	52
(3.7.4.2) SD (Snare), T1-T4 (Toms), Aux.....	53
(3.7.4.3) HH (Hi-Hat), C1 - C4 (Cymbals).....	54
(3.7.5) Trigger Input Advanced Settings	55
(3.7.5.1) KD (Kick)	55
(3.7.5.2) SD (Snare), T1 - T4 (Toms), Aux	56
(3.7.5.3) HH (Hi-Hat)	57
(3.7.5.4) R (Ride), C1 - C4 (Cymbals)	59
(3.7.6) Stacks	60
(3.8) USB Recording.....	64

(4.0) Settings	65
(4.1) Info.....	65
(4.2) WI-FI.....	66
(4.3) Bluetooth	66
(4.4) MIDI	67
(4.5) Hardware	68
(4.6) General	69
(5.0) Troubleshooting	70
(6.0) Appendix.....	71
(6.1) Kit List.....	71
(6.2) MIDI Mapping.....	73
(6.3) Technical Specifications	75
(6.4) Trademarks & Licenses	76

(1.0) Introduction

(1.1) About this User Guide

This manual will help you get familiar with using your PRIME drum module. For consistency, the terminology throughout is based on electronic drum kit nomenclature. We also used specific formatting to indicate particular topics of significance:

Important/Note: Important or helpful information on a given topic.

Names of buttons, controls, parameters, settings, and other options are written in **bold** characters throughout the manual.

Examples: Tap the **KIT** button to see a list of the different Kits.

To change the settings, tap the area to highlight the field and turn the **Main Encoder**.

Some parts of this manual refer to other relevant chapters or sections, which are cited in **bold, italic blue** characters. Click the text to skip immediately to that section.

Examples: Items not listed in *Introduction > Box Contents* are sold separately.

See the section *Operation > Mix Mode* for more details on Mix mode.

(1.2) Box Contents

PRIME Drum Module

Quickstart Guide

Assembly Guide

Box Contents Sheet

Safety & Warranty Manual

(1.3) Support

For guides, firmware updates, and other content, visit: alesis.com/strataprime/downloads.

For the latest information about this product (system requirements, compatibility information, etc.) and product registration, visit alesis.com.

For additional product support, visit support.alesis.com.

(1.4) Setup

Your PRIME drum module runs the powerful BFD software sound engine with tons of editing capabilities, easily accessible from the 10.1" touchscreen. Editing is made easy, following the steps below.

Note: Some parameters have multiple pages. Swipe right on the lower part of the screen to go to the next page; swipe left to go to the previous page.

Follow these steps to start playing a Kit in the PRIME drum module:

1. Study the [Connection Diagram](#) section.
2. See the [Hi-hat Setup](#) section for proper calibration.
3. Load a Preset Kit or a Playlist from [Kit Mode](#).
4. Use [Edit](#) mode to assemble a custom kit or further modify the underlying drum sounds.
5. Each Trigger Zone has presets already set to optimize each of the Trigger inputs. You can select from a list of known/tested triggers or hi-hat control pedals. The presets contain basic settings, Tweak “behind the scenes” settings, and Advanced settings. If needed, you can save your own trigger presets. See the [Trigger Input Tweaks](#) section for more details.
6. Use [Mix](#) mode to process the sounds, adjusting sound volume levels, panning, and add Insert Effects.
7. Audition a Drum sound by using the drum pads or pedal, or by tapping the Kit display graphic in [Edit](#) mode.

Note: If you experience crosstalk symptoms (vibrations of a struck pad are picked up by other pads' trigger sensors causing double triggering of sounds), follow the troubleshooting tips in the [Crosstalk](#) and [Learn XTalk](#) sections.

8. Use [Jam](#) mode (also known as Backing Track mode) to record your drumming to a track or load a song to practice your drumming along to your favorite music.

Consult the [Operation](#) section for a more detailed guide to the main aspects of using the PRIME drum module.

(1.4.1) Connection Diagram

Items not listed in [Introduction > Box Contents](#) are sold separately.

Note: Refer to the Assembly Guide and Box Contents sheet included with your purchase for full kit setup instructions.

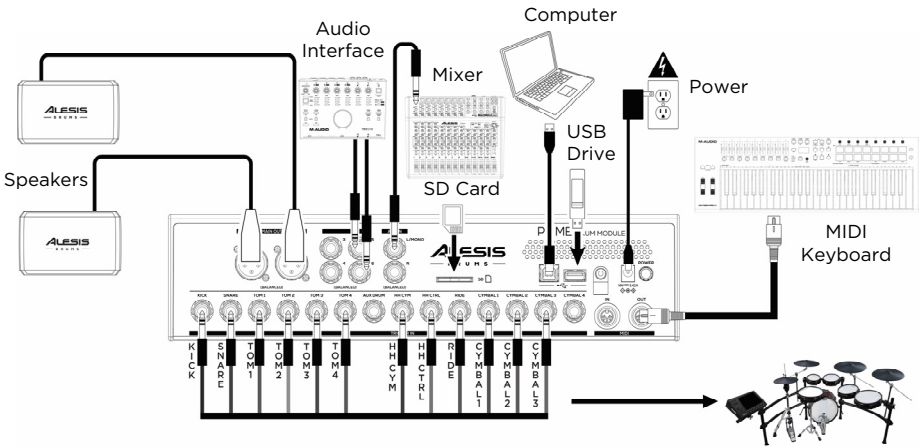

(2.0) Features

(2.1) Top Panel

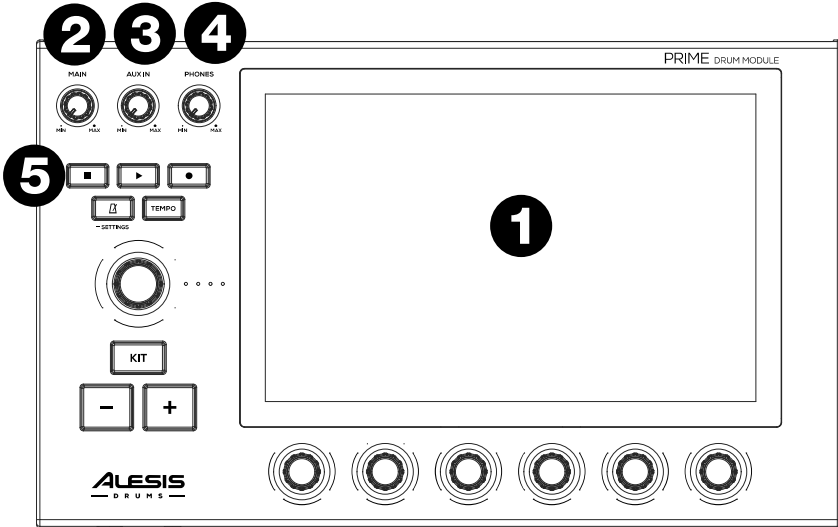

1. Display

This full-color 10.1" (257 mm) multi-touch display shows information relevant to the current operation. Touch the display (and use the hardware controls) to control the interface. See the following [Operation](#) section to learn more about using PRIME drum module's interface.

2. Main

Turn this knob to adjust the level of the **Main Outputs**.

3. Aux In

Turn this knob to adjust the level of the **Aux Inputs**.

4. Phones

Turn this knob to adjust the level of the **Headphone Outputs**.

5. Transport Controls

Use these controls to start/stop playback and recording of a sequence.

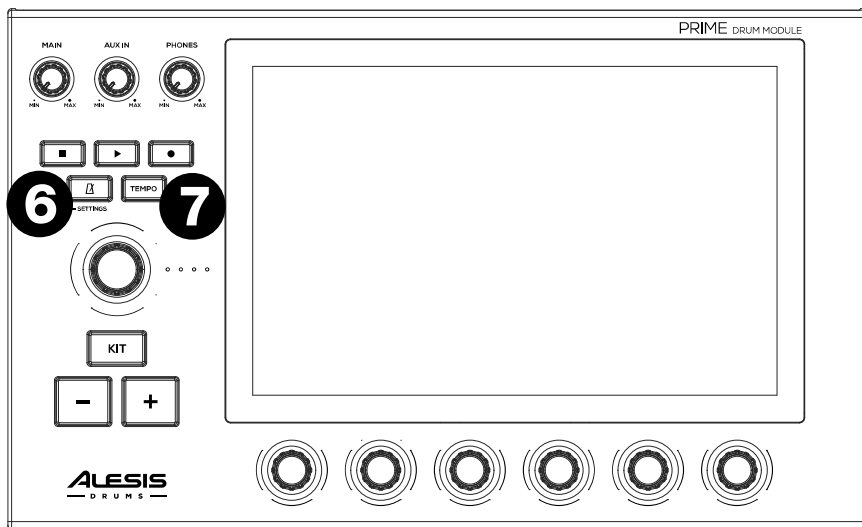

6. Click

Press this button to turn the click on or off. Press and hold this button to view the click settings listed below. To change the settings, tap the area to highlight the field and turn the **Main Encoder**.

- **BPM:** Use the **Tempo** button to set the BPM in this mode (20-999.)
- **Beats:** Selects the number of beats in a measure. If this is set to 4, the first beat will be articulation one, followed by three articulation twos (1-30).
- **Division:** Select the note value of each beat, relative to the BPM (1/4, 1/4T, 1/8, 1/8T, 1/16, 1/16T, 1/32, 1/32T).
- **Sound:** Select the preset sound that will be used for the click (Clap, Metroclick, Drum Module Click, Shake, Sidestick 1, Sidestick 2, Tambourine, Cowbell).
- **Output Volume:** Sets the overall output volume for the click sound (-INF - +6 dB). Double tap the Volume slider to reset the level to 0 dB.
- **Main Out 1/2:** Selects the volume level that the click will be routed to Main Out 1/2 (0-100). Double tap the Trim slider to reset the level to 80.
- **Headphones:** Selects the volume level that the click will be routed to the Headphones (0-100). Double tap the Trim slider to reset the level to 80.
- **Assign Out 3/4:** Selects the volume level that the click will be routed to Assign Out 3/4 (0-100). Double tap the Trim slider to reset the level to 80.
- **Assign Out 5/6:** Selects the volume level that the click will be routed to Assign 5/6 (0-100). Double tap the Trim slider to reset the level to 80.

7. Tempo

Press this button at least three times in succession to set the BPM.

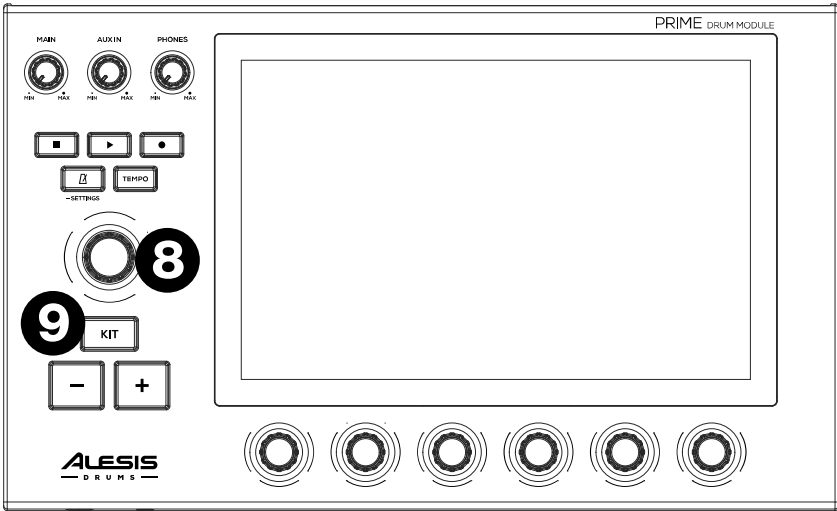

8. Main Encoder

Turn and press this encoder to change kits, edit on-screen parameters, etc.

9. Kit Button

Press this button to toggle between the Kit mode/menu screen and whatever the last selected mode/menu window screen that was selected.

- **Kit Mode:** Kit mode is a kind of home page that lets you select kits but also navigate to other “Modes.” This window also includes controls for Kit Volume, Track Volume, Click Volume, Ambience Volume, HiHat Bottom, and Snare Rim. See the section [Operation > Kit Mode](#) for more details.
- **Edit Mode:** Opens Edit mode, where you can make changes to individual kit pieces. See the section [Operation > Edit Mode](#) for more details.
- **Mix Mode:** Opens Mix mode, where you can apply effects and control audio levels, panning, and other mixer parameters. See the section [Operation > Mix Mode](#) for more details.
- **Jam Mode:** Opens the Jam mode (also known as Backing Track mode) to record yourself playing or recording from the **Aux Inputs**, a connected Bluetooth audio device, or load a recorded performance or audio track from a connected USB drive or SD card.
- **Trigger Mode:** Opens Trigger Settings mode where you can adjust a wide variety of parameters to customize the feel of your electronic triggers, as well as calibrate your hi-hat and crosstalk settings. See the section [Operation > Trigger Mode](#) for more details.
- **Settings:** Click the “gear” icon to open Global Settings where general info like the firmware version can be found and changes to WiFi, Bluetooth, MIDI, Hardware and General settings can be made. See the section [Settings](#) for more details.

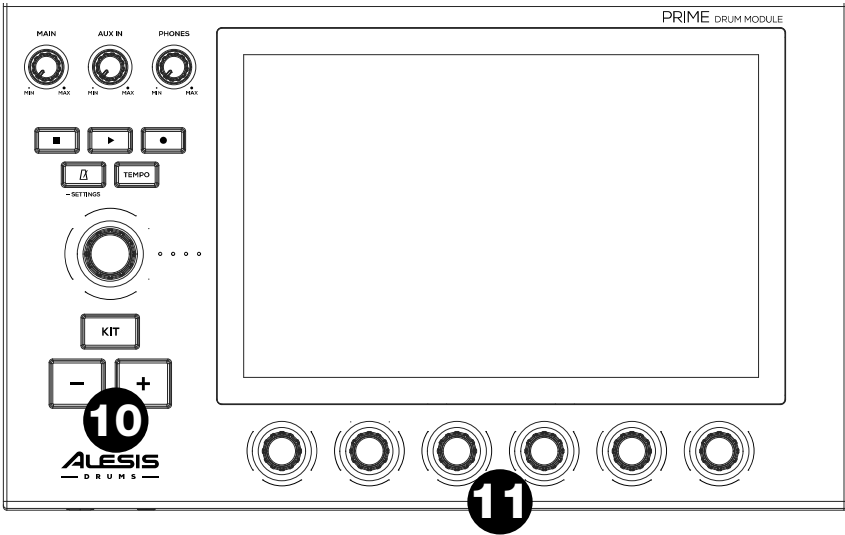

10. +/- Buttons

The +/- buttons select the primary items in each mode. Please see each mode's operation section for more details.

11. Small Encoders

Turn these 360° potentiometers to adjust the various parameters found at the bottom of the touchscreen display. Additionally, when multiple banks of parameters are available above the Small Encoders, swipe left/right on the touchscreen to change the banks. Double tap any parameter to reset it back to default values.

(2.2) Rear Panel

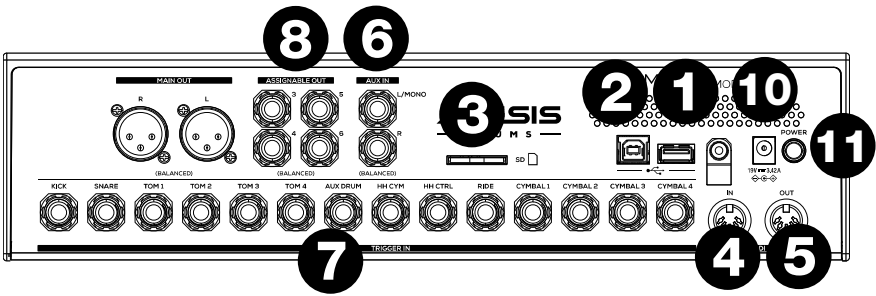

1. USB-A Port

Use this to connect a MIDI controller or update the firmware.

2. USB-B Port

Connect to a computer's USB port to send/receive MIDI data, update firmware, or transfer files.

3. SD Card Slot

Insert an SD, SDHC, or SDXC card (ex-FAT or FAT32 formatted) to import samples.

4. MIDI Input

Connect this MIDI input to external MIDI devices, such as an electronic percussion pad, or other MIDI controller devices.

5. MIDI Output

Connect this MIDI output to external MIDI devices, such as a synthesizer, drum machine, sequencer, or sound module.

6. Aux Inputs (1/4" TRS [6.35 mm])

Connect these inputs to an audio source (smartphone, mixer, etc.). Use these inputs to record to an audio track, sample a sound, or for use as a live play-along.

7. Trigger Inputs (1/4" TRS [6.35 mm])

Note: Refer to the included *Assembly Guide* for more assistance on connecting Strata PRIME kit drums and cymbals.

Connect cables here to receive signals from drum and cymbal triggers, and a hi-hat pedal.

8. Assignable Out

Route these physical outputs to Main, Assign 3/4, or Assign 5/6 (configured in the Mixer menu) to assign individual Instruments or Busses.



9. Main Outputs (XLR)

Connect these outputs to your monitors, mixer, recorder, etc. By default, Outputs 1/2 are routed here.

10. Power Input

Connect the included 19V 3.42A center positive power adapter here.

11. Power Button

Press this button to power the PRIME drum module on or off. When powering PRIME off, the system will ask if you want to save your changes (see image below). Do not disconnect the power cable while the module is still shutting down.

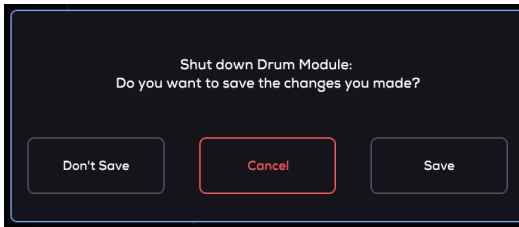

(2.3) Front Panel

1. Headphone Output

Connect your 1/4" (6.35 mm) headphones here. You can customize the mix to the headphones in *Mix* mode.

2. Headphone Output

Connect your 1/8" (3.5 mm) headphones here. You can customize the mix to the headphones in *Mix* mode.



(2.4) Bottom Panel

1. Module Mount

Connect the included module mount to PRIME's bottom panel using the supplied 4 screws to secure to the rack. Use M5x14 mm Phillips head screws only. Do not use longer screws.



(3.0) Operation

Important: To start using the PRIME drum module, first make sure you have properly set up the drum kit and connected the trigger cables to the PRIME drum module. See the *Assembly Guide* and *Box Contents* sheet included with your purchase for more details.

(3.1) Kit Mode

Kit mode will be in focus when you first power on the PRIME drum module. This is where you can easily access various modes, load a Kit, change kit parameters, and quickly start playing your PRIME drum kit.



To start playing a kit:

1. Power on the module to be in Kit mode. The Kit (at the top left of the display) will be highlighted.
2. Turn the **Main Encoder** to scroll through Kits.
3. **To load the selected kit**, press either of the **-/+** buttons to immediately load a kit. Turn the **Main Encoder** to be presented with a prompt to “push to load” the **Main Encoder** to load the kit or select “return to kit” to cancel browsing.
4. **To edit basic parameters of the selected Kit Piece**, turn the 6 **Small Encoders** on the module to adjust Kit Volume, Track Volume, Click Volume, Ambience Volume, HiHat Bottom transition time, and the Snare Rim sound.

For more advanced editing of Kits, go to [Browse Mode](#) section.

See the listing below for details on the following features of Kit mode:



1. **Browse:** Use this mode to load a Preset Kit or a Playlist.
 2. **Edit:** Use this mode to assemble a custom kit or further modify the underlying drum sounds.
 3. **Mix:** Use this mode to adjust the volume balance of your kit, apply effects, and route your sounds to various outputs of the PRIME drum module.
 4. **Jam:** Use this mode (also known as Backing Track mode) to record, play, save, and load audio files. You can also practice your drumming and play along to your favorite music, or record your performance.
 5. **Trigger:** Use this mode to customize the drum kit to your playing style.
 6. **Settings:** Use this menu to configure the PRIME drum module's overall operation.
 7. **Currently Selected Kit:** Shows the selected Kit.
 8. **Playlist Name/Icon:** Shows the currently loaded Playlist and icon.
 9. **Kit Volume:** Use the first 360° **Small Encoder** to adjust the loaded kit's overall output volume (-INF - 0.00 - +6.00 dB).
 10. **Track Volume:** Use the second 360° **Small Encoder** to adjust the playback volume for a loaded backing track (-INF - 0.00 - +6.00 dB). This is the same volume that is seen in **Jam Mode > Track Volume**.
 11. **Click Volume:** Use the third 360° **Small Encoder** to adjust the volume of the click playback (-INF - 0.00 - +6.00 dB).
 12. **Ambience Volume:** Use the fourth 360° **Small Encoder** to adjust the ambience effect volume (-INF - 0.00 - +6.00 dB).
 13. **HiHat Bottom:** Use the fifth 360° **Small Encoder** to adjust the point at which the hi-hat's open sounds transition to closed sounds, and also where the "chick" or "splash" sounds are started. (100 - 2048).
- Note:** Double-tap a parameter to reset it to the default value.
14. **Snare Rim:** Use the sixth 360° **Small Encoder** to select to use a Side Stick or Click sound when triggering the snare rim.

(3.1.1) Kit Piece Mode

When you first power on the drum module, you will be in Kit mode, with a Kit focus. To get to Kit Piece focus to change drums/cymbals per Kit Piece, tap a slot on the kit graphic to bring you to Kit Piece focus. Tap anywhere outside the kit graphic or on the kit name to bring you back to Kit focus. The 6 parameters on the bottom of the display will change when you swap focuses.



To select a Kit Piece slot, tap on a drum/cymbal in the drum kit graphic. The piece will be highlighted in the lower left corner of the display.

To change the Kit Piece on a selected slot, press either of the **-/+** buttons to immediately load a Kit Piece. You can also turn the **Main Encoder** to be presented with a prompt to “push to load” and push the **Main Encoder** to load the Kit Piece. Tap anywhere on the kit graphic to cancel browsing through that Kit Piece.

To edit basic parameters of the selected Kit Piece, turn the 6 **Small Encoders** on the module.

For more advanced editing of Kit Pieces, go to the [Edit Mode](#) section.

See the listing below for details on the following features of Kit Piece mode:

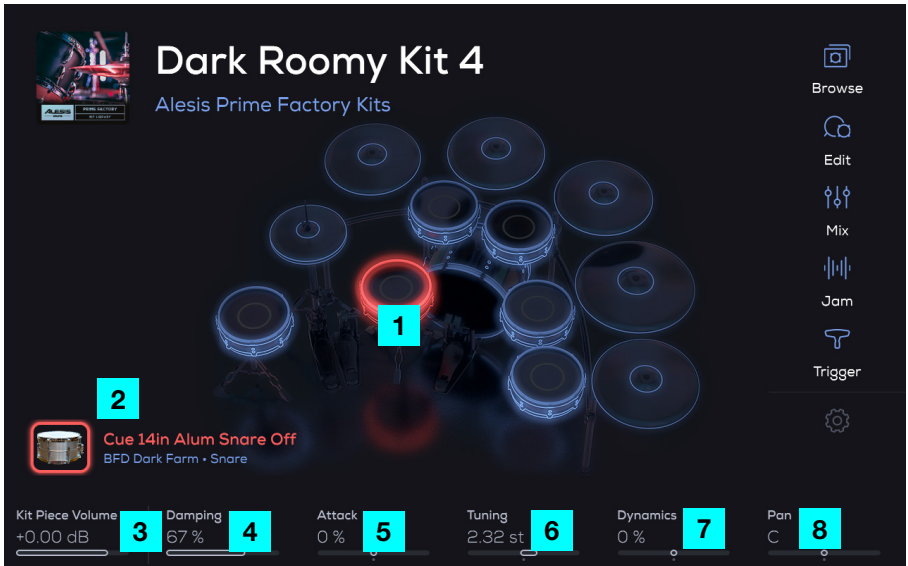

- Kit Graphic:** Tap a Kit Piece on the kit graphic to have that Kit Piece selected at the bottom of the screen. Use the **Main Encoder** and **-/+** buttons to control the Kit Piece shown.
- Kit Piece:** Shows the currently selected Kit Piece after tapping on a Kit in the Kit Piece graphic. When in Kit Piece focus, access the parameters in the graphic above for easy editing. Use the **Main Encoder** and **-/+** buttons to control the Kit Piece shown. See the [Edit Mode](#) section for further editing details.
- Kit Piece Volume:** This is the overall volume of the loaded Kit Piece (**-INF - 0.00 - +6.00 dB**).
- Damping:** This will naturally reduce the sustain time from the Kit Piece, similar to muffling acoustic drums or cymbals with tape or gel (**0 % - 100 %**).
- Attack:** This will increase or decrease the amount of attack for the Kit Piece, without affecting the natural dynamics (**-100 % - 100 %**).
- Tuning:** This adjusts the tuning for the drums and their pitch, giving a higher or lower sound to the drum (**-12.00 st - 12.00 st**).
- Dynamics:** This adjusts how sensitive the Kit Piece is to your performance. Higher settings will reduce dynamic range, allowing your performance to cut through more easily when needed. Conversely, lower settings will increase dynamic range (**-100 % - 100 %**).
- Pan:** This controls the pan of the Kit Piece in the Mixer (**100 L - C - 100 R**).

(3.2) Browse Mode

Use this mode to access various kit and Playlist functions as detailed below.

All Kit list items found in Browse mode contain a playlist number, a kit name, a library name, and an options button.

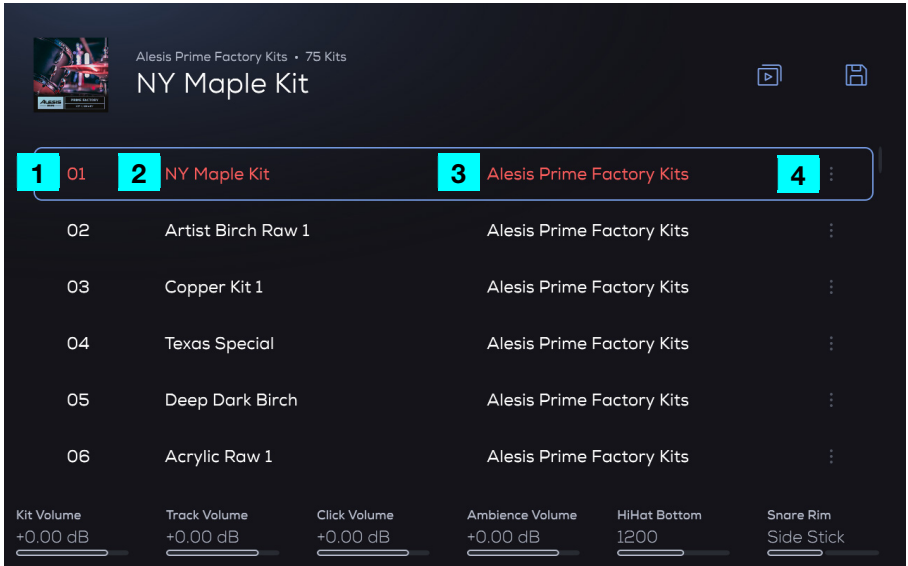

1. **Playlist Number:** A sequential number of the kit in the playlist.
2. **Kit Name:** Displays the name of the kit.
3. **Library Name:** The original library from which the kit is derived, which will always be from the Factory Library or the User Library.
4. **Options Button:** Tap this to access kit and playlist management options as follows.

(3.2.1) Browse Mode Functions

To scroll through kits or edit on-screen parameters, turn the **Main Encoder**. Press the **Main Encoder** to load the selected kit.

To immediately load the next or previous kit, use the **+/-** buttons.

To toggle between the Kit menu and other active modes, press the **Kit button**.

Adding a Kit to a Playlist:

1. In Browse mode, scroll to find a Kit from the Factory Kits using the **Main Encoder**.
2. Tap the 3 vertical dots at the end of a kit to select.
3. Tap the option **Add to Playlist** option.
4. Tap the **+** icon to create and name your new Playlist (using the touchscreen keyboard).
5. Tap the check mark on the keyboard to add the kit to the playlist.

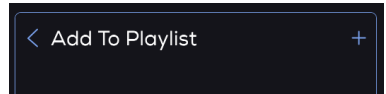

Saving a Kit to your User Library:

1. In Browse mode, scroll to find a Kit from the Factory Kits using the **Main Encoder**.
2. Tap the 3 vertical dots at the end of the selected kit.
3. Tap the option **Save As** option.
4. Name the Kit and press the checkmark on the touchscreen keyboard to save the Kit to your User Library.

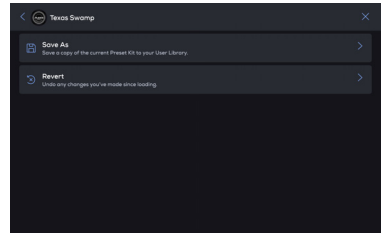

Renaming a User Kit:

1. In Browse mode, tap the **Playlist icon** to access the Playlist feature.
2. Tap the list of User Kits.
3. Tap the 3 vertical dots at the end of the User kit.
5. Select **Rename** and name the Kit from the touchscreen keyboard.
6. Press the checkmark on the touchscreen keyboard to rename the Kit.

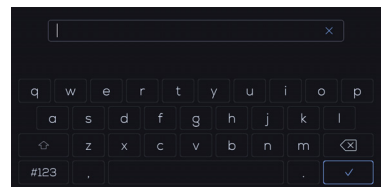

Reverting a User Kit:

1. In Browse mode, tap the **Playlist icon** to access the Playlist feature.
2. Tap the list of User Kits.
3. Tap the 3 vertical dots at the end of the User kit.
4. Select **Revert** to go back to the way the kit was since loading the kit.

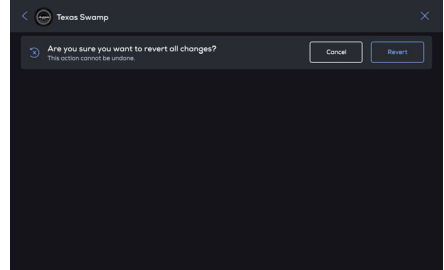

To change to another Playlist:

1. In Browse mode, tap the **Playlist icon** to access the Playlist feature.
2. In the Playlist Selection page, select from the available Playlists by either tapping a Playlist item or turning the **Main Encoder** to move the cursor to a different Playlist.
3. Press the **Main Encoder** or tap on screen to enter the Playlist and view all of the Kits in it.

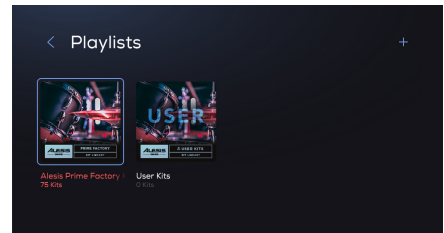

Creating a New Playlist:

1. In Browse mode, tap the **Playlist icon** to access the Playlist feature.
2. Tap the **+** icon to create and name your new Playlist (using the touchscreen keyboard).
3. Tap the **Save icon** to save a copy of the current Preset Kit to your User Library.

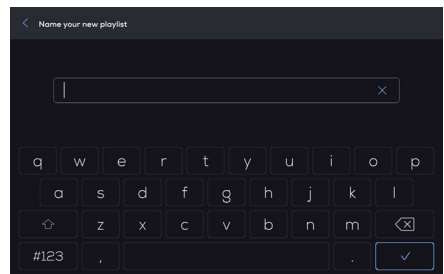

(3.3) Edit Mode

To open **Edit mode**, press the **Kit** button and then tap **Edit** on the right edge of the screen.

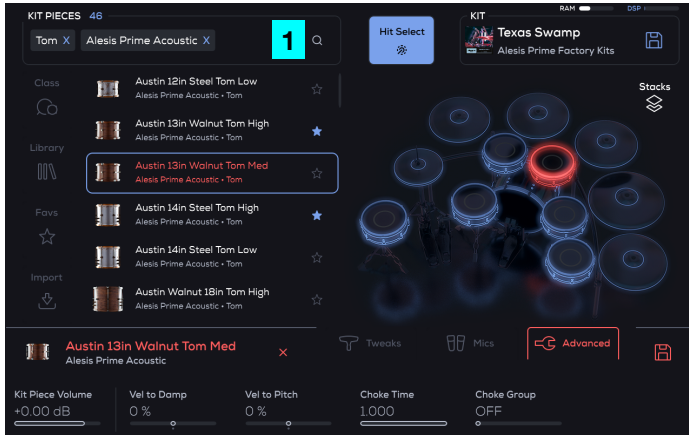

1. Search

The Search Bar shows the contents of the Browser List. There can only be four different types of filters in the search bar at one time:

- **Class** (Snare, Percussion, etc.).
- **Library** (NY Maple Kit, Roto Kit, Vintage Kit 2, User, etc.)
- **Favs** (Favorites) Kit Pieces that you have starred.
- **User defined search** (via touch keyboard entry): This is used to manually search for Kit Pieces. A numerical list of the current search results is shown next to **KIT PIECES** above the **Search** bar.

To manually search for kit pieces:

1. Press the area near the magnifying glass icon in the filter box. An overlay with a generic keyboard will appear.
2. Enter a search term.
3. Tap the check mark at the bottom right of the keyboard or cancel the action by tapping the back arrow at the top left.

Filtering out content from the Search Bar

For example, if you only want Kick references to show up in the Search, tap “Class” and select “Kick” from the class menu. This will filter out all other classes of kit pieces (snare, toms, cymbals, etc.) from your search results. If you would like to remove a filter, click the **X** next to that filter in the search bar. Clicking the **X** next to the Kick filter will now show all pieces including Kicks. The search results list will update automatically.

Note: When a Kit Piece is highlighted in the search results window, you can tap from left to right on the highlighted Kit Piece to hear the different velocity/dynamics of the Kit Piece. This is useful if you want to hear how a Kit Piece will play at different dynamics. You can also tap on the drum kit graphic to audition one velocity. This can be toggled on or off in the **Settings** menu.

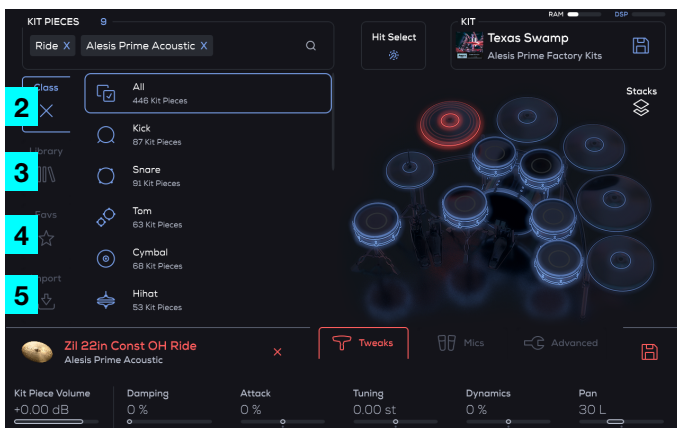
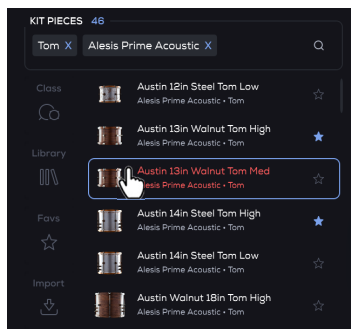

2. Class

Tap this option to see a list of the different Kit Piece categories (All, Kick, Snare, Tom, Cymbal, Hi-hat, Ride, Crash, China, Splash, Stack, Gong, Percussion, Sequenced, Pitched, and SFX).

3. Library

Tap this option to see a list of the different Kits (NY Maple Kit, Roto Kit, Vintage Kit 2, User, etc.).

4. Favs

Tap this option to see a list of Kit Pieces you have favorited. You can favorite Kit Pieces by tapping the star icon. See the **Favs** section for more details.

5. Import

Tap to import samples and Kit Pieces from an SD card or USB flash drive. See the section **Importing Samples** for more details.

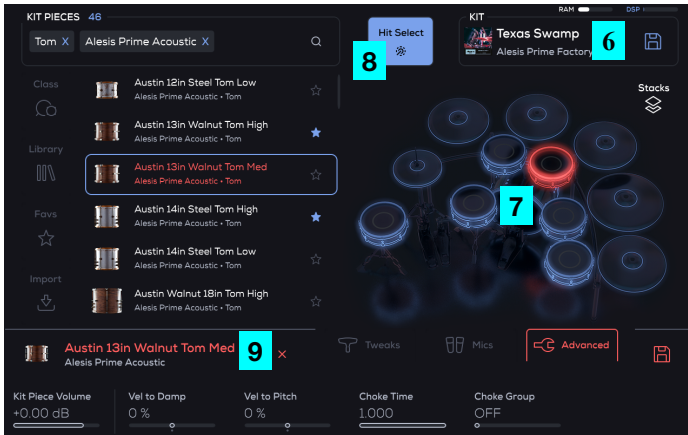

6. Current Kit Name

This shows the name of the loaded kit. Tap the **save icon** next to the kit name to save it.

7. Kit Display

This shows a visual representation of the Strata Prime Kit. Tap on any of the kit pieces in the UI to select that drum or cymbal pad for editing its assigned kit piece sound.

8. Hit Select

This feature gives the ability to hit a drum/cymbal/pedal attached to that trigger input and the drum module focus will change to that Trigger Slot. This is the same as if you were to tap the Kit displayed in the UI.

In the Settings mode you can choose to have the **Hit Select** button be set to momentary instead of latch. When set to **Momentary**, the **Hit Select** button defaults to off, and you can tap and hold the **Hit Select** button in the UI to keep the **Hit Select** button temporarily active. When Hit Select is off, the currently selected Trigger Slot never changes based on incoming trigger events. However, you can still change the Trigger Slot by tapping the Kit displayed in the UI. When set to **Latch**, tap the **Hit Select** button to toggle the “note chase” feature on or off. You can also adjust the minimum velocity / threshold next to the momentary/latch option for the Hit Select feature. A higher setting will take more velocity to trigger. A lower setting will more easily trigger.

Note: By default, the Hit Select feature only responds to hits coming from the trigger inputs. It does not respond to incoming MIDI In port or USB MIDI signals. You can adjust this in the **Settings > General** menu.

9. Current Kit Piece Name

Shows the name of the loaded Kit Piece. A Kit Piece can be loaded to a pad by double-tapping a Kit Piece, pressing the **Main Encoder** on the currently selected Kit Piece or by tapping the check mark (icon) next to the currently highlighted Kit Piece.

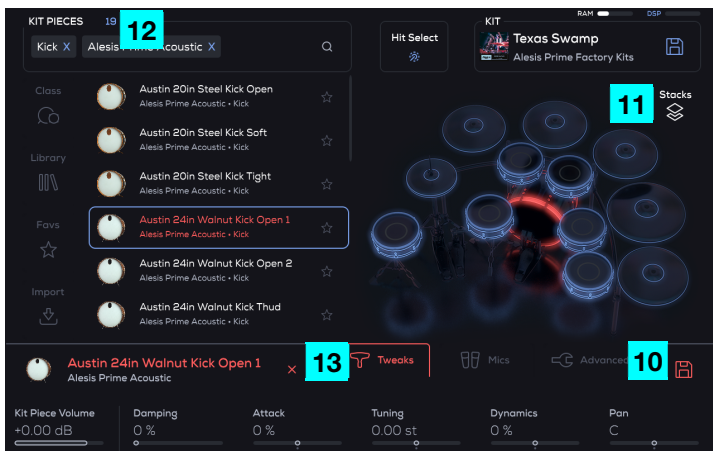

10. Preset Kit Save

Save the current Kit Piece as a duplicate in a user library of choice.

11. Stacks

Browse and layer Articulations on top of the Kit Piece, and directly to the individual Trigger Slots.

12. Kit Pieces Number

Shows the number of Kit Pieces available from the filtered Search results.

13. Tweaks

This shows various sample playback parameters that can be adjusted using the **Small Encoders**.

- **Kit Piece Volume:** This is the overall volume of the loaded Kit Piece (**-INF - 0.00 - +6.00 dB**).
- **Damping:** This will naturally reduce the sustain time from the Kit Piece, similar to muffling acoustic drums or cymbals with tape or gel (**0 % - 100 %**).
- **Attack:** This will increase or decrease the amount of attack for the Kit Piece, without affecting the natural dynamics (**-100 % - 100 %**).
- **Tuning:** This adjusts the tuning for the drums and their pitch, giving a higher or lower sound to the drum (**-12.00 st - 12.00 st**).
- **Dynamics:** This adjusts how sensitive the Kit Piece is to your performance. Higher settings will reduce dynamic range, allowing your performance to cut through more easily when needed. Conversely, lower settings will increase dynamic range (**-100 % - 100 %**).
- **Pan:** This controls the pan of the Kit Piece in the Mixer (**100 L - C - 100 R**).

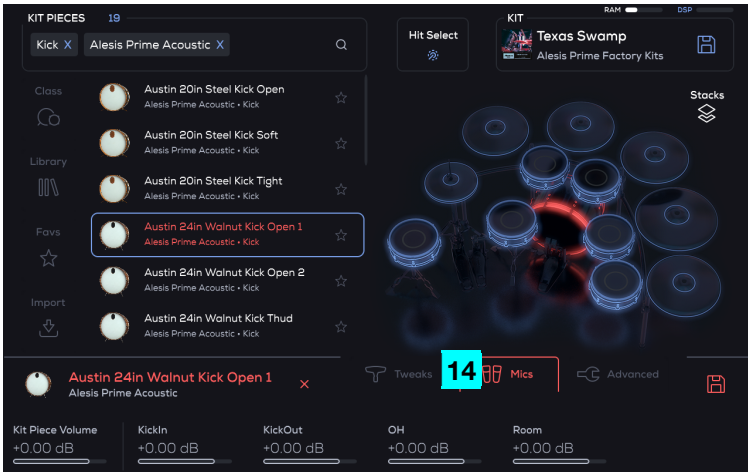

14. Mics

This shows the individual mic channels, which are adjusted using the **Small Encoders**, and how much of the channel is sent to the Mixer.

- **Kit Piece Volume:** The overall volume of the loaded Kit Piece ($-INF - 0.00 - +6.00$ dB).

Important: The following is a list of all controllable parameters. The Kit Piece that is selected determines which parameters will be shown.

The volume parameters for any mic channel are $-INF - 0.00 - +6.00$ dB. The names of the mic channels vary depending on the types of mic techniques used in the Kit Piece library you are playing. Some common mic channel names you will find are:

- **Direct ($-INF - 0.00 - +6.00$ dB):** Controls the mic channel's volume for the direct volume of the Kit Piece being sent to the Mixer.
- **KickIn ($-INF - 0.00 - +6.00$ dB):** Controls the mic channel's volume for the inside microphone volume of the Kick Drum being sent to the Mixer.
- **KickOut ($-INF - 0.00 - +6.00$ dB):** Controls the mic channel's volume for the outside microphone volume of the Kick Drum being sent to the Mixer.
- **Snare Bottom ($-INF - 0.00 - +6.00$ dB):** Controls the mic channel's volume for the bottom microphone volume of the Snare Drum being sent to the Mixer.
- **Snare Top ($-INF - 0.00 - +6.00$ dB):** Controls the mic channel's volume for the top/head microphone volume of the Snare Drum being sent to the Mixer.
- **OH ($-INF - 0.00 - +6.00$ dB):** Controls the mic channel's volume for the overhead microphone volume of the Kit Piece being sent to the Mixer.
- **Room ($-INF - 0.00 - +6.00$ dB):** Controls the mic channel's volume for the room microphone volume of the Kit Piece being sent to the Mixer.

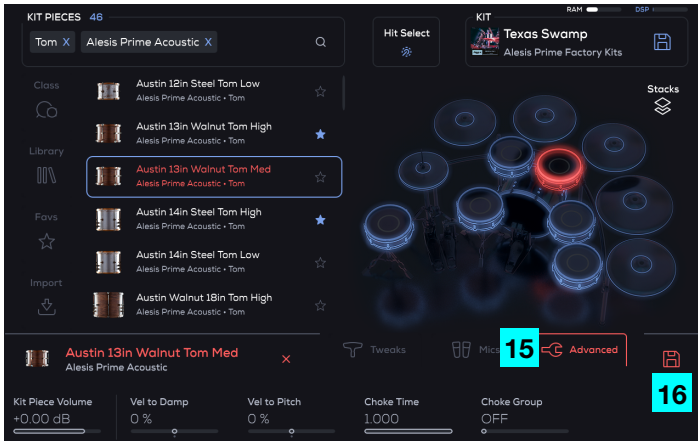

15. Advanced

This shows more advanced tone and sample playback settings that can be adjusted using the **Small Encoders**.

- **Kit Piece Volume:** The overall volume of the loaded Kit Piece (**-INF - 0.00 - +6.00 dB**).
- **Vel to Damp:** The louder the drum sound is, the more the sound will be dampened (**-100 - 100%**). Positive values will increase damping with higher velocities, while negative values will reduce damping with higher velocities.
- **Vel to Pitch:** This determines how much the velocity of a strike will affect the layer's tuning (**-100 - 100%**). Positive values will increase pitch with higher velocities, while negative values will decrease pitch with higher velocities.
- **Choke Time:** Sets the time it takes for the Choke Group to decay when muting each other (**0.000 - 1.000**).
- **Choke Group:** Any Kit Pieces assigned to the same Choke Group will mute each other (**OFF, 0-19, ALL**).

16. Save Preset Kit Piece

Saves a copy of the current Preset Kit Piece to your User Library.

To Save a Kit Piece:

1. Tap the disk icon in the top right corner next to the current kit name.
2. Select **Save As** (or select **Revert** to undo any changes you've made to the kit piece) and enter a kit piece name to save it as a User Kit Piece.

(3.4) Edit Mode Functions

From the Kit menu, tap the **Edit** option to access this mode. This is where you can edit/customize kits by changing the Kit Pieces for each Trigger Slot, as well as change the playback/tone of those Instruments (sounds).

The right-side image shows the Kit display graphical interface in Edit mode representing the pads and cymbals connected to PRIME’s trigger inputs.

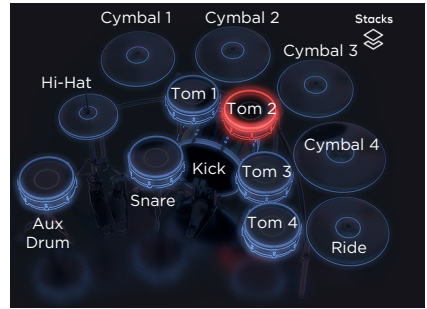

Below is a table showing the Trigger Slots, the available Trigger Zones, and which Trigger Zone is auditioned/played when the graphic is tapped.

Trigger Slot	Trigger Zone 1	Trigger Zone 2	Trigger Zone 3	Audition Zone
Snare	Head	Rimshot	Rim Only	Head
Kick	Head	N/A	N/A	Head
Tom 1	Head	Rimshot	Rim Only	Head
Tom 2	Head	Rimshot	Rim Only	Head
Tom 3	Head	Rimshot	Rim Only	Head
Tom 4	Head	Rimshot	Rim Only	Head
Aux	Head	Rimshot	Rim Only	Head
Hi-hat	Bow	Edge	Bell	Bow
Ride	Bow	Edge	Bell	Bow
Cymbal 1	Bow	Edge	Bell	Edge
Cymbal 2	Bow	Edge	Bell	Edge
Cymbal 3	Bow	Edge	Bell	Edge
Cymbal 4	Bow	Edge	Bell	Edge

(3.4.1) Changing Kit Pieces for a Trigger Slot

To change a Kit Piece within a Trigger Slot, use one of these three options:

Via Main Encoder

While in Edit mode, select the Trigger Slot you would like to change by either tapping on the Kit display or by using the Hit Select feature.

Turn the **Main Encoder** to navigate the list of Kit Pieces. Once the new Kit Piece is selected, push the **Main Encoder** to load the Kit Piece.

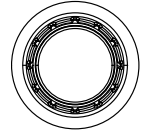

Via +/- Buttons

Press the +/- buttons to immediately load the next/previous Kit Piece in the list.



Via “Tap to Load”

Select the **Trigger Slot** via the Kit display graphic or use the **Hit Select** feature.

Browse the list of Kit Pieces by swiping through the list. To highlight an item in the list, simply tap it.

To load the Kit Piece, tap the check mark.

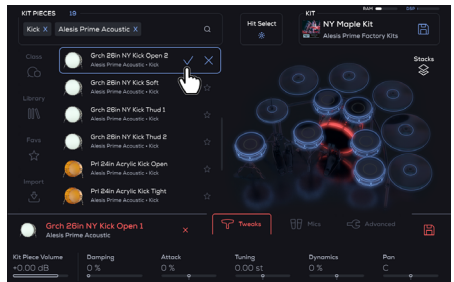

Note: When a Kit Piece is highlighted in the search results window, you can tap from left to right on the highlighted Kit Piece to hear the different velocity/dynamics of the Kit Piece. This is good if you want to hear how a Kit Piece will play at different dynamics. You can also tap on the drum kit graphic to audition one velocity. This can be toggled on or off in the Settings menu.

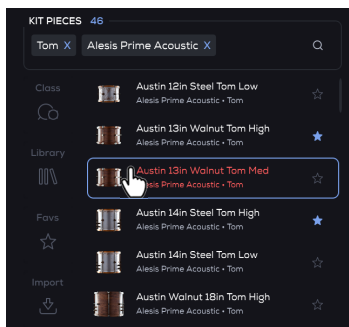

(3.4.2) Saving and Reverting Kits

To save a Kit to your User Library, tap the **Save** button at the top right corner of the Edit page.

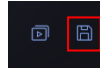

Alternatively, tap the **Options** icon and then select **Save As** to save a copy of the current Preset Kit to your User Library.

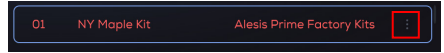

To undo any changes made since loading the kit, tap the **Save** button and select **Revert**.

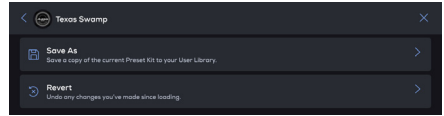

(3.4.3) Class



Tap the **Class** option to view a list of the different Kit Piece categories (All, Kick, Snare, Tom, Cymbal, Hi-hat, Ride, Crash, China, Splash, Stack, Gong, Percussion, Sequenced, Pitched, and SFX).

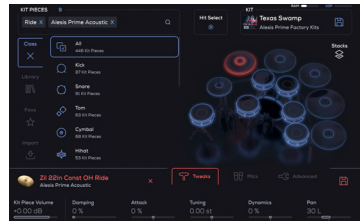

(3.4.4) Library



Tap the **Library** option to view a list of the different Kits (NY Maple Kit, Roto Kit, Vintage Kit 2, User).

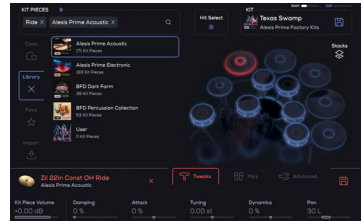

(3.4.5) Favs

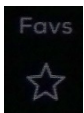

Tap the **Favs** icon to view a list of kit pieces you have favorited. Swipe or use the Encoder to quickly scroll through the list, and then tap or press the Encoder to load your preferred Kit Pieces.

To add Kit Pieces to the Favs list, tap the **star icon** found in the Library.

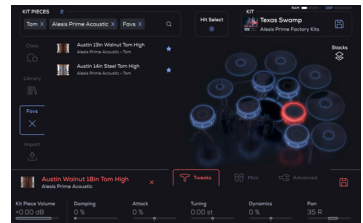

(3.4.6) Importing Samples

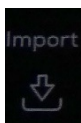

The PRIME drum module allows you to import your audio files and assign them to any slot of your Kit.

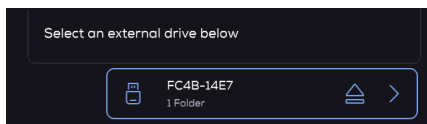

To import a file from a device:

1. Tap the **Import** option.
2. Scroll with the **Encoder** to search for samples and Kit Pieces on a connected USB drive or inserted SD card.
3. Press the **Encoder** to load the selected file.

The following file types are supported:

- **.WAV**, **.MP3**, and **.AIFF** files (44.1, 48, 88.2, 96 kHz sample rates that are 24, 16, or 8-bit)

Use the file browser to look for the type of file you want to load.

Play ▶: Previews the audio file without loading it.

Back ◀: Go to the previous folder in the current folder navigation.

Select: If a folder is highlighted, double tap the folder or press the **Encoder** to enter that folder. If a file is highlighted, double tap the file or press the **Encoder** to select and load the file.

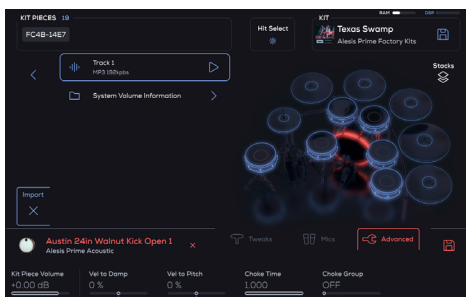

Audio files will be converted into Kit Pieces and put into the User Kit Piece Library.

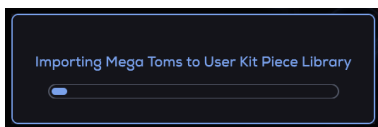

(3.5) Mix Mode

(3.5.1) Easy View



To open **Mix Mode**, press the **Kit** button and then tap **Mix** on the left edge of the screen.

In Mix Mode Easy view, this is the default mode that the Mixer loads into.

You can switch to Advanced (ADV) view by toggling the “Easy” switch in the top right corner to “ADV”, highlighted in red in the image below.

1. Selected Kit

This shows the name of the loaded kit.

2. Drum Channels

This shows the names of the drum trigger slots as mixer channels.

3. Pan Controls

Adjusts the pan control of the channel in the mixer (100 L - C - 100 R)

4. Volume Controls

Adjusts the volume for the drum channel.

- **Kit Volume:** Adjusts the volume for all channels for the kit.
- **Kick:** Adjusts the volume for the Kick channel.
- **Snare:** Adjusts the volume for the Snare channel.
- **All Toms:** Adjusts the volume for all Tom channels.
- **All Cymbals:** Adjusts the volume for all Cymbal channels.
- **Ambience Volume:** Adjusts the level of the Ambient Mix, the three insertable Effects that can be added to the AmbMix channel in the Advanced view.

(3.5.2) Advanced View

Adjust the **ADV** switch to toggle the Mixer to Advanced view. This gives full control of the BFD sound engine at your fingertips. Here you can use the touchscreen to adjust the volume balance of your kit, apply effects, and more.



1. Drum Mics

This grouping of the drum trigger slots shows the corresponding mixer channel.

- Kick
- Snare
- Tom 1
- Tom 2
- Tom 3
- Tom 4
- Aux

Kick, Snare, Tom 1, Tom 2, Tom 3, Tom 4, Aux Parameters

Parameter	Description	Value Range
Volume	Channel volume	INF dB, - -99.19 - 0 - 6.00 dB
Pan	Channel Pan	100 L - C - 100 R
Headphone Trim	Adjusts the volume going to the Headphone Out based on the Main Out's volume.	-100 - 0 - 100 %
Reverb Amount	Controls the send level of the channel to the reverb bus	0 - 100 %
Reverb Preset	Displays the Reverb plugin preset name	Click on the Reverb Preset > to select from a list of effects.
FX Amount	Controls the percent of the send level going to the FX bus	0 - 100 %

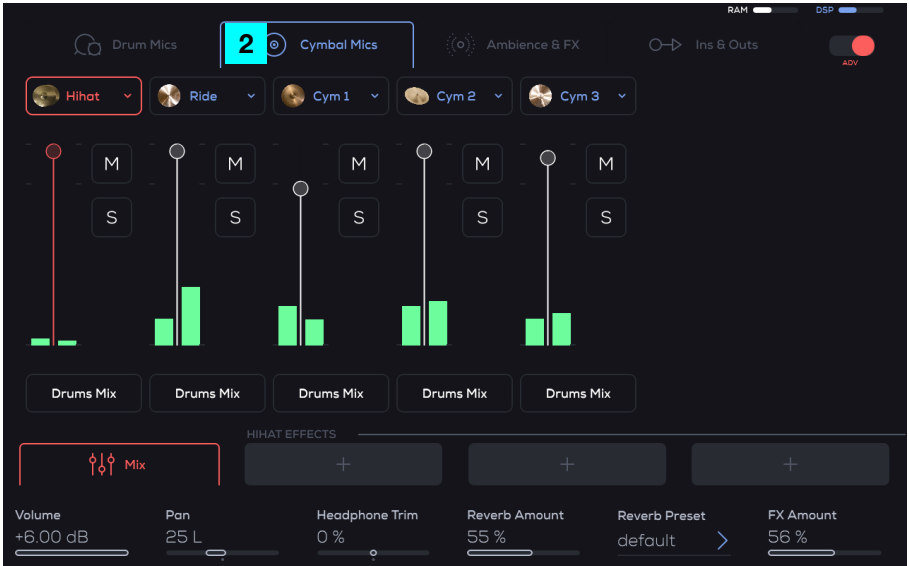

2. Cymbal Mics

This grouping of the cymbal trigger slots shows the corresponding mixer channel.

- Hi-hat
- Ride
- Cym1 (Cymbal 1)
- Cym2 (Cymbal 2)
- Cym3 (Cymbal 3)
- Cym4 (Cymbal 4)

Hi-hat, Ride, Cymbals 1-4 Parameters

Parameter	Description	Value Range
Volume	Channel volume	-INF - 0.00 - +6.00 dB
Pan	Channel Pan	100 L - C - 100 R
Headphone Trim	Adjusts the volume going to the Headphone Out based on the Main Out's volume.	-100 - 0 - 100 %
Reverb Amount	Controls the send level of the channel to the reverb bus	0 - 100 %
Reverb Preset	Displays the Reverb plugin preset name	Click on the Reverb Preset > to select from a list of effects.
FX Amount	Controls the percent of the send level going to the FX bus	0 - 100 %

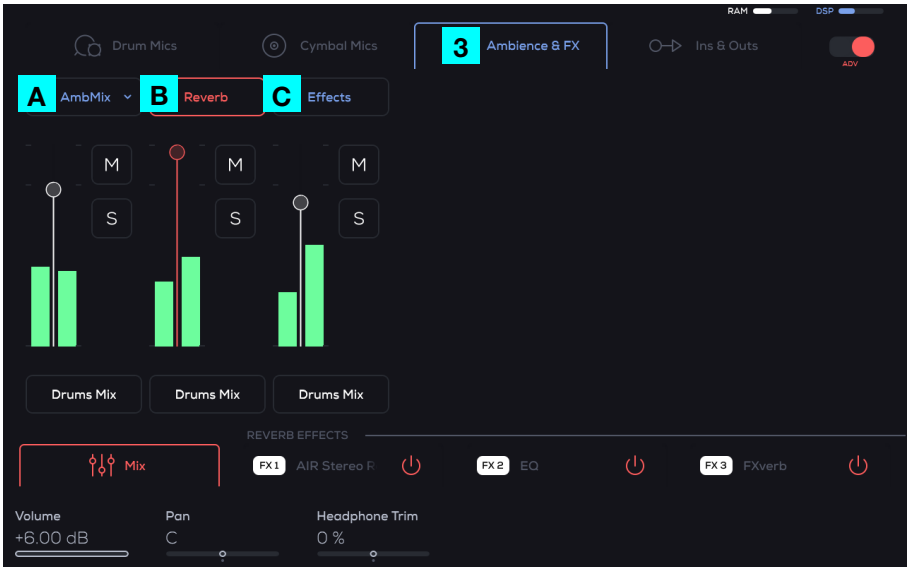

3. Ambience & FX

This has the grouping of the Reverb and Effects Sends for the Drums Mix, Assign 3/4, and Assign 5/6.

- A. **AmbiMix** (Ambient Mix): Shows This channel includes 3 insertable Effects that can be added to the AmbiMix channel. The amount of Kit Piece audio being set to this channel is controlled via the **Small Encoders** controlling the OG and Room values in the Edit's Mics page.
- B. **Reverb**: This channel includes 3 insertable Effects that can be added to the Reverb channel. The amount of Kit Piece audio being set to this channel is controlled via the **Small Encoder** controlling the Reverb Amount value.
- C. **Effects**: This channel includes 3 insertable Effects that can be added to the Effect channel. The amount of Kit Piece audio being set to this channel is controlled via the **Small Encoder** controlling the FX Amount value.

Note: For **AmbiMix**, **Reverb**, and **Effects**, additional parameters may be available depending on what effects are added to the FX slots.

Reverb, Effects, and AmbiMix Parameters

Parameter	Description	Value Range
Volume	Channel volume	-INF - 0.00 - +6.00 dB
Pan	Channel Pan	100 L - C - 100 R
Headphone Trim	Adjusts the volume going to the Headphone Out based on the Main Out's volume.	-100 - 0 - 100 %

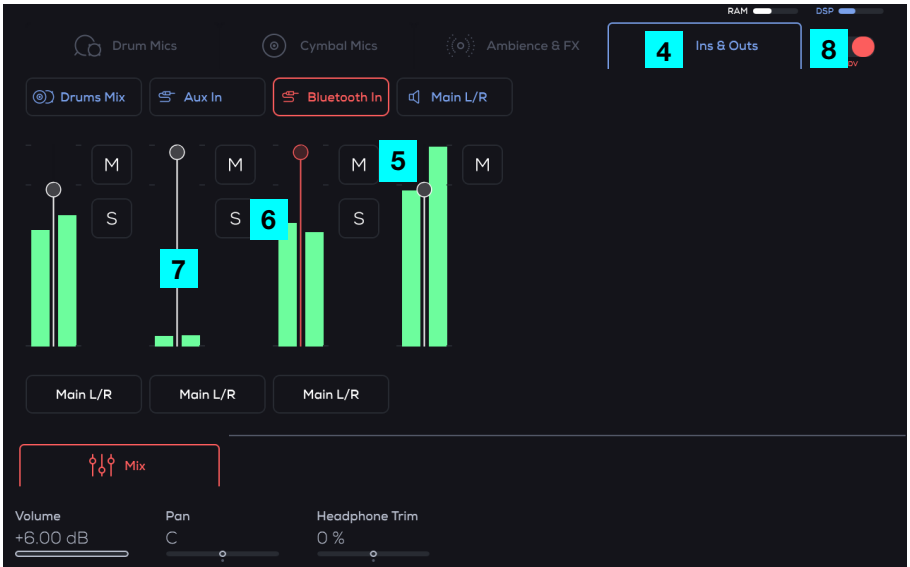

4. Ins & Outs

This section routes the Drum Mix, Aux In, Bluetooth In, Main L/R, Assign 3/4, and Assign 5/6 to the Main L/R, Assign 3/4, or Assign 5/6 outputs.

5. Mute

Press to mute a mixer channel.

6. Solo

Press to solo a mixer channel. All other channels will be muted.

Note: When a channel has Mute or Solo enabled, the corresponding tab will show a yellow icon for Solo or a red icon for Mute so you can quickly reference the channel status.

7. Fader

Adjust this to control the volume level of the mixer channel.

8. Easy > ADV (Advanced)

Adjust this to switch from Easy view to Advanced view for a more detailed layout of volume, pan, effects, muting, and soloing controls.



9. Output Routing

You can select from Main L/R (this default setting receives all channels), Assign 3/4, or Assign 5/6.

To route audio from different outputs:

1. In the Mixer page “groups” of mixer channels, tap on the tabs to select a different mixer channel group. When an instrument track that has a dropdown arrow is pressed, you will see the Mixer levels for all of the microphones available for that Kit Piece.
2. Tap the **Drums Mix** button. Select to route the audio to the different hardware outputs (**Assign 3/4** or **Assign 5/6**).

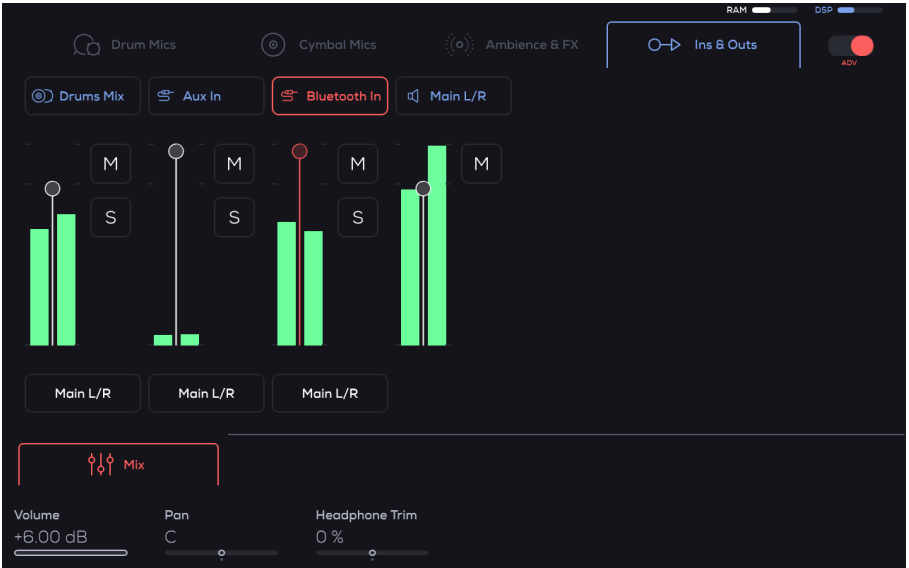

Drums Mix, Aux In, Bluetooth In, Main L/R, Assign 3/4, Assign 5/6 Parameters

Parameter	Description	Value Range
Volume	Channel volume	-INF - 0.00 - +6.00 dB
Pan	Channel Pan	100 L - C - 100 R
Headphone Trim (Aux In only)	Adjusts the volume going to the Headphone Out based on the Main Out's volume.	-100 - 0 - 100 %

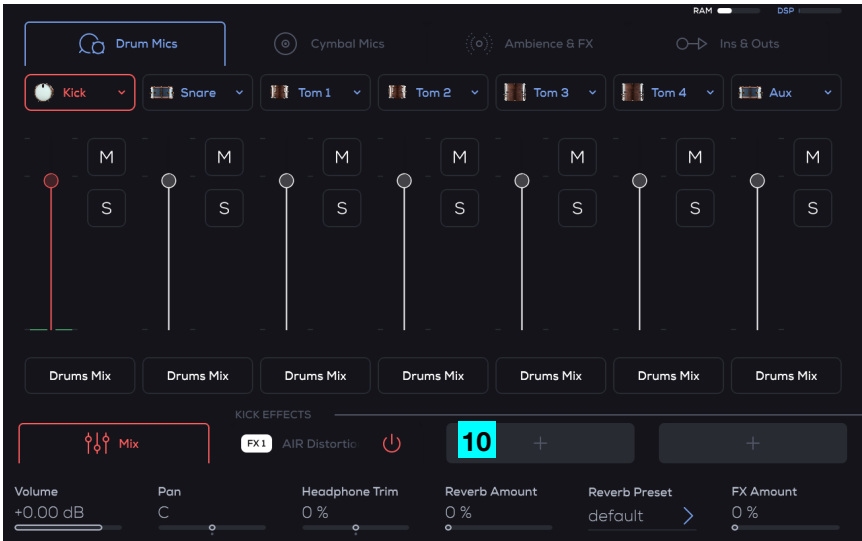

10. Insert FX Slots

To assign an Insert effect to a channel, tap the **+** button to open the **effect select** screen. Once in the **Effect Select** screen you will see the list of available effects. You can select an effect by tapping the **+** or by tapping the effect's name.

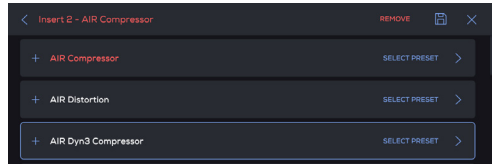

To select an effect's preset, tap **SELECT PRESET** on the screen. Once you have entered the Select Preset window you will see a list of the available effect presets for the selected effect.

You can tap any of these effect presets to load it. Once you have found one that you like, you can then back out of the **Effect Select** screen by tapping the **<** icon in the top left of the screen until you return to the **Mixer** window.

To add effects to a channel, tap the power button on a tab to enable an effect. Then tap any other area of the "tab" besides the power button to select the effect. Tap any other area of the "tab" a second time to bring up an overlay for browsing and managing effects. Here you can browse all effects and presets. Tap any of these to load it. Back out of the Effect Select screen by tapping the **<** icon in the top left of the screen until you return to the Mixer window.

To control the amount of effect for each Pad, adjust the slider for the channel.

To adjust an effect's parameters:

1. In the **Mixer** window tap the effect in the **Effect Slot** you would like to change.
2. Once an effect has been selected it will be highlighted in red, and its parameters will be shown above and will be controllable by the six **Small Encoders**. If additional parameter pages for an effect are available, there will be page indicators above the parameters.
3. Slide your finger left or right on the parameters to go to a different page.

To Save an Effect Preset:

1. Tap the effect slot with the currently loaded effect you would like to save to enter into the **effects select** screen.
2. In the **effects select** screen, tap the **Save** icon in the top right.
3. Once you have tapped the **Save** icon, a keyboard will appear where you will be able to name your preset effect.
4. Once you have entered in the name of your new effect preset, tap the check mark. You will now be brought back to the **Mixer** window and your new effect preset will be saved to that effect preset's **User** folder.

(3.6) Jam Mode

Jam mode (also known as Backing Track mode) lets you record, play, save, and load audio files. Use this mode to practice your drumming and play along to your favorite music, or record your performance.

To open Jam mode, press the **Kit** button and then tap **Jam** on the right edge of the screen.

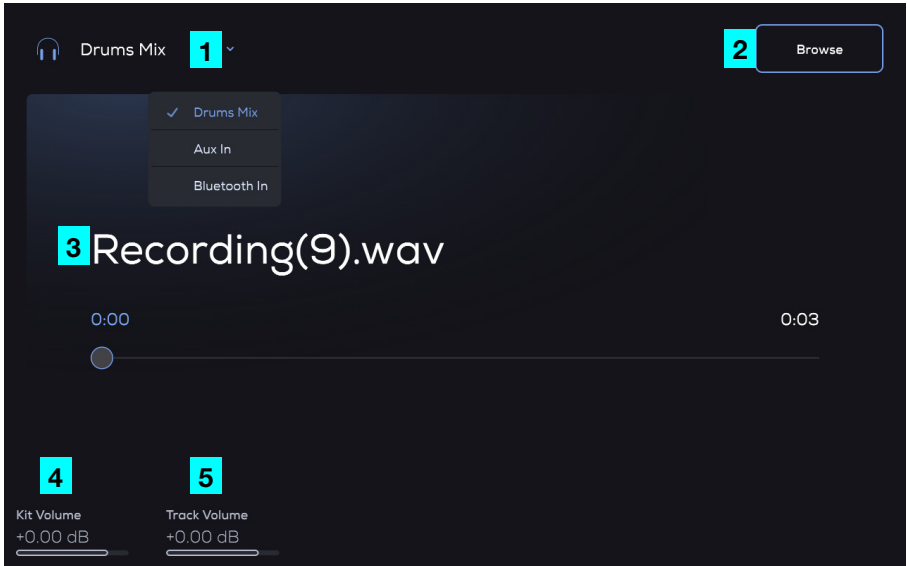

1. Headphone Monitoring

Select to monitor audio from the Aux In, Bluetooth In, or the Drums Mix.

2. Browse

Import .WAV, .AIFF, or .MP3 files from storage (SD/USB), or listen to previous **Recordings** by tapping Browse.

3. Recording

Press the **Record** button to record audio here.

4. Kit Volume

Adjusts the overall drum kit volume using the **Small Encoders**.

5. Track Volume

Adjusts the audio track's playback volume using the **Small Encoders**.

To load an audio track:

1. Select and load a kit from **Kit mode**.
2. Enter Jam mode and tap the **Browse** button to load an audio track from a source (external USB drive or SD storage). Select **Drums Mix** from the Headphone Monitor dropdown list to monitor the audio.
3. Play the audio by pressing the **Play** button and begin playing drums along with it.

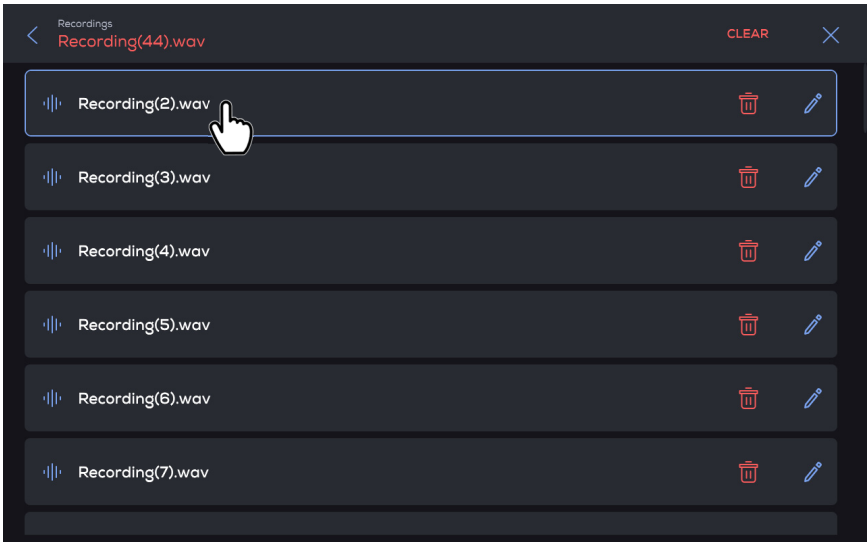
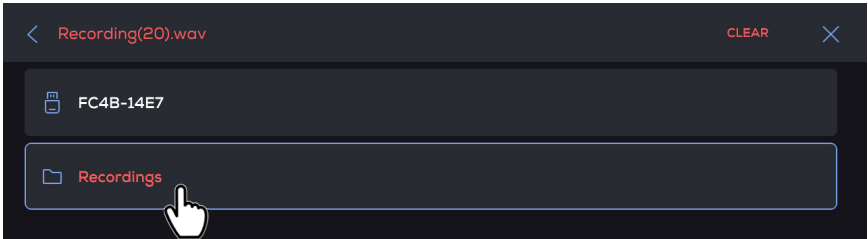

To rename an audio track, click the pencil icon and use the keyboard that appears to rename your recording.

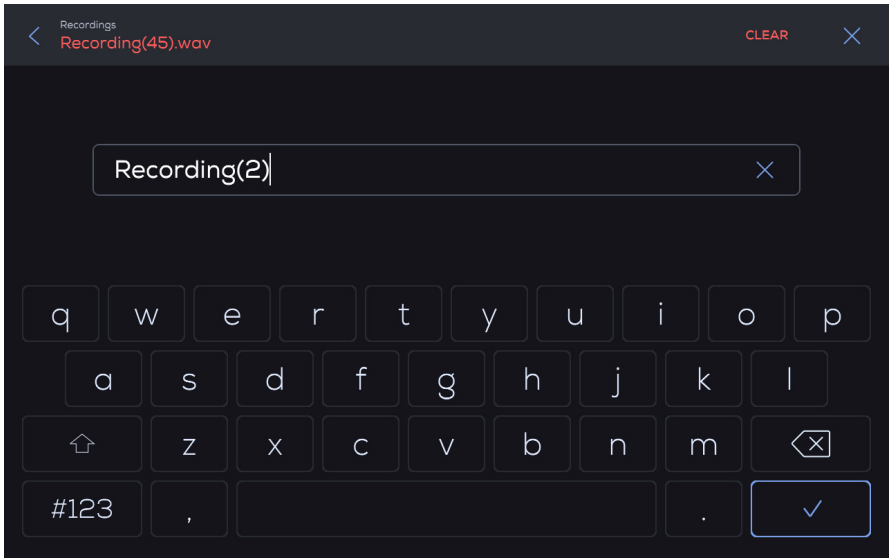
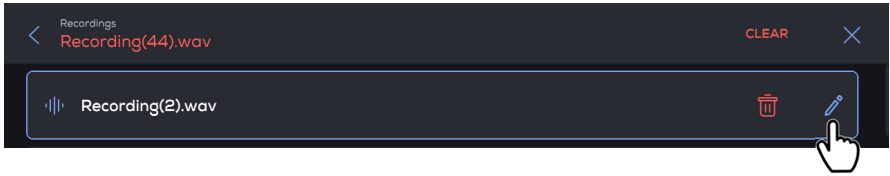

To delete an audio track, click the trash can icon and use the keyboard that appears to rename your recording.

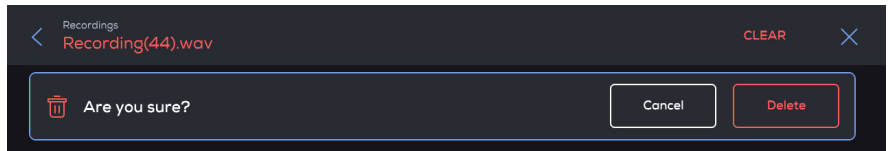
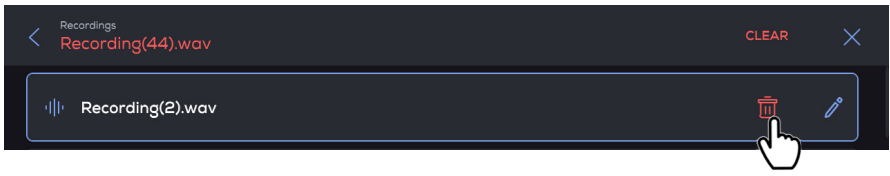

(3.7) Trigger Mode

To open **Trigger mode**, press the **Kit** button and then tap **Trigger** on the right edge of the screen.

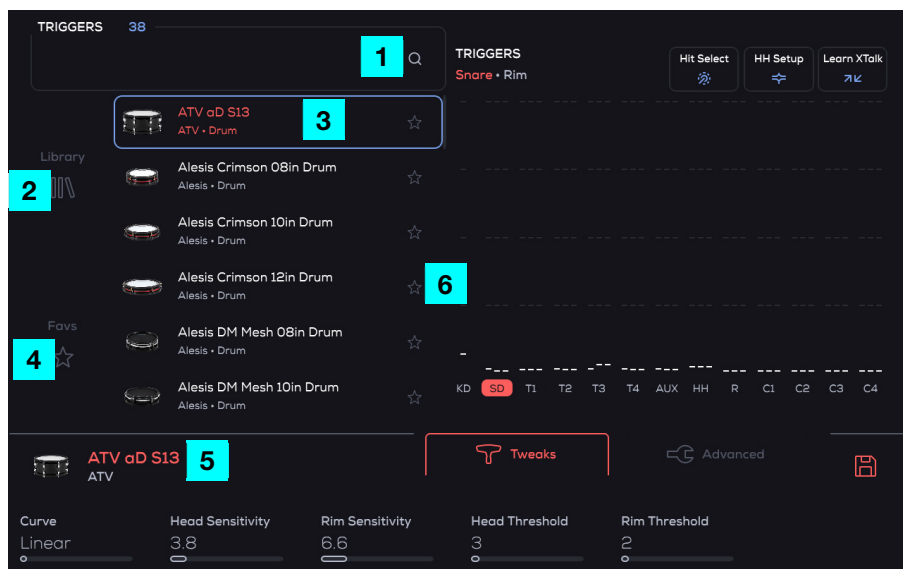

1. Search

Tap the magnifying glass icon to bring up the keyboard and enter the name of the trigger preset you are searching for.

2. Library

Tap to select a preset drum trigger from this list.

3. Browser

Shows a list of the Trigger Presets as filtered by the Search bar.

4. Favs

Tap to see a list of Kit Pieces that you have favorited to easily recall when needed.

5. Trigger Preset

Displays the currently loaded trigger preset name.

6. Favorite

Tap the star icon to favorite a Kit Piece to easily recall when needed.

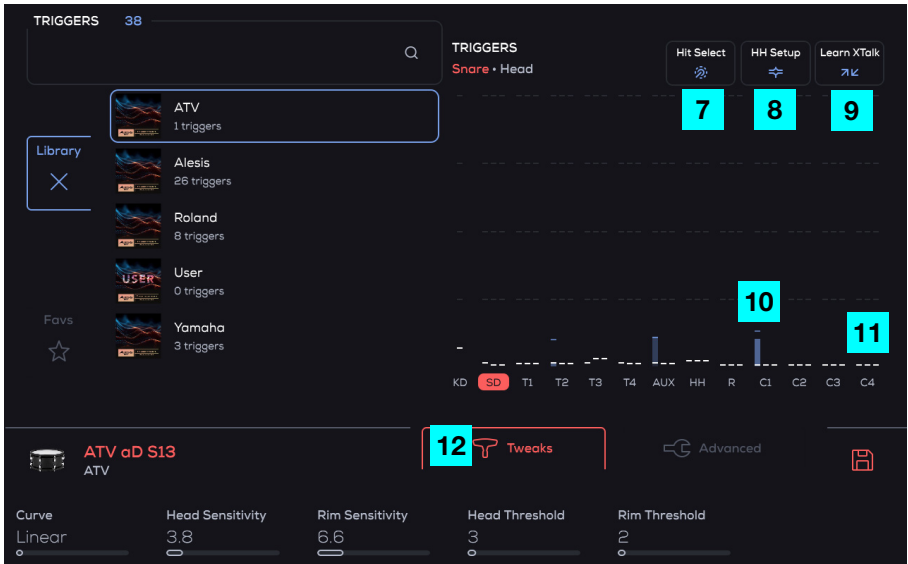

7. Hit Select

Selects a Trigger Slot on-screen by hitting the trigger connected to that trigger input. When set to Latch mode, toggle this setting on or off by tapping the button. When set to Momentary mode, press and hold this button to enable Hit Select.

8. HH Setup

Press to bring up the hi-hat calibration procedure overlay to adjust the hi-hat's open position optimally. See the section [Hi-Hat Setup](#) for more details.

9. Learn XTalk

Enter this mode to learn to filter out vibrations which are causing unwanted triggering. See the section [Learn XTalk](#) for more details.

10. Trigger Meters

Shows bars for the incoming trigger signals. A vertical block displays the incoming trigger event with the height of it corresponding to the MIDI velocity.

11. Threshold Indicator

These white dashes show what the Head Threshold, Rim Threshold, and cymbal Threshold is set to. An incoming trigger event will only be heard if the signal goes above the threshold setting.

12. Tweaks

Shows various trigger settings for the trigger inputs. See the section [Trigger Input Tweaks](#) for more details.

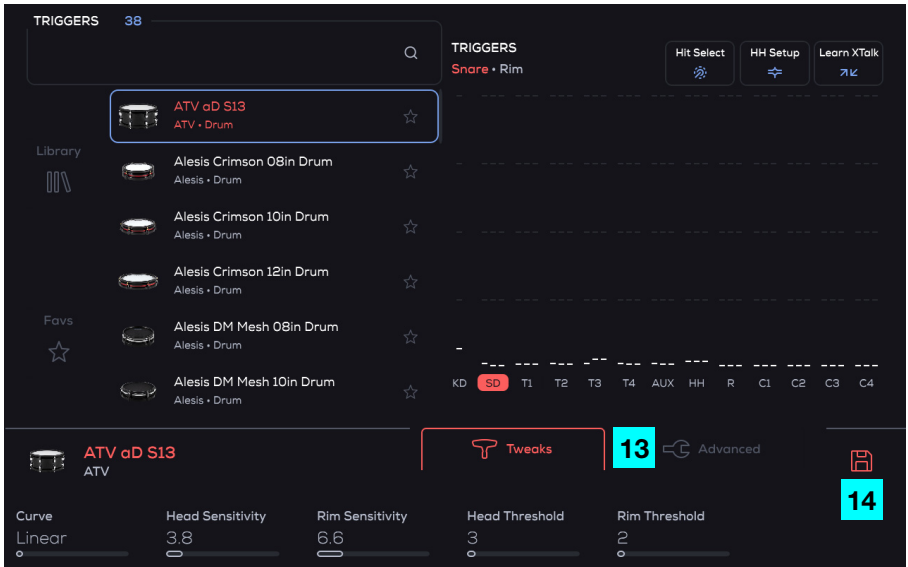

13. Advanced

Shows more advanced trigger settings for the trigger inputs. See the section [Trigger Input Advanced Settings](#) for more details.

14. Save

Save a copy of the current trigger preset to your User Library, or revert changes you have made since loading.

(3.7.1) Trigger Zones

Trigger Zones are the arrival point to the software for data from the Trigger Inputs. Voltage is used for high-resolution velocity.

In **Trigger mode**, you can tap the zone objects to bring up Trigger settings for editing.

Each Trigger Zone is broken down into multiple articulations. Articulations are chosen based on the analysis of the Trigger Input signal. Kit Pieces are the collection of articulations that comprise an instrument. For example, a snare drum is a Kit Piece, and is comprised of the articulations **Head**, **Rimshot**, **Rim Click**, and **XStick**. Each articulation is assigned a MIDI note and plays the sound in that Trigger Zone.

To select the different Trigger Slots, tap the **Hit Select** option or tap the letters at the bottom of the meter section as seen below.

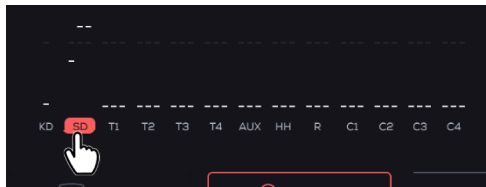

(3.7.2) Crosstalk

When striking a trigger causes another trigger to sound unexpectedly, it is referred to as crosstalk (or XTalk). This is a normal part of all electronic drum kits, and Alesis has created a new easy and automatic method for removing it.

Out of the box, the PRIME drum module has default crosstalk filter sections that should work well in most instances. If there is any remaining crosstalk (such as if a cymbal is mounted in an unexpected position), then you can either listen for the crosstalk, and/or look at the meters on the trigger mode to see if crosstalk is occurring. If it is, then select the trigger that is CAUSING the crosstalk, and begin XTalk Learn on that.

Follow these tips to further troubleshoot crosstalk:

- Make sure your drum and cymbal pads aren't touching each other or their clamps.
- Firmly tighten (but do not overtighten) the clamps that fasten the pad to the stand to ensure it is securely attached.
- Adjust the tightness of the cymbal wingnuts. Wingnuts that are too loose can let the cymbal overly "bounce," which can cause unwanted vibrations through the boom arm and rack. Alternatively, wingnuts that are too tight do not allow enough "bounce," so the force from a strike will transfer directly to the rack.
- If possible, set up your kit on a soft, carpeted surface. Hard floors will generally cause more vibration through the drum rack.

(3.7.2.1) Learn XTalk



The Crosstalk Elimination page is accessed by tapping **Learn XTalk** in Trigger mode. This allows you to quickly filter out vibrations across the drum kit which can cause unwanted triggering. Only one Trigger Slot can be programmed at a time.

1. XTalk Filter

Turn this on or off to enable or disable crosstalk filtering.

2. XTalk Boost

This setting adjusts the offset between when the crosstalk signal is received and when the crosstalk filtering occurs.

3. Save

Stores all current crosstalk values and exits to Trigger mode.

4. Cancel

Reverts back to the crosstalk values learned before most recently entering the mode, and returns to Trigger mode.

5. Clear

Erases any learned crosstalk values.

To remove crosstalk:

1. From Kit mode, go to Trigger mode.
2. Select **Learn XTalk** and follow the on-screen instructions.
3. Hit all of the Trigger Zones on the selected Trigger Input a few times. For best results, avoid hitting other triggers. The **Trigger Zone** info will be shown as well as the **Trigger Meter** and **Peak Marker** for the Trigger Slot.
4. Little red dashes will appear indicate the crosstalk values that were learned and will be filtered once you complete the calibration.
5. Once changes have been made, tap **Save**. Repeat this process for any other drums or cymbals you are experiencing crosstalk with.

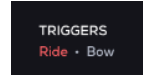

Trigger Zone

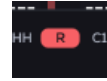

Trigger Meter

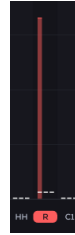

Peak Meter

(3.7.3) Hi-Hat Setup

The hi-hat controller mounts on a normal hi-hat stand underneath the cymbal pad, and tracks the relative position of the cymbal as you move the hi-hat pedal. The PRIME drum module will detect the position of the pedal.

To adjust the playability to personal preference, use this calibration procedure below.

1. Tap the **HH Setup** button at the top right of the Trigger menu. This will bring up a quick calibration procedure overlay with instructions.
 - A live meter of the hi-hat controller data will be seen, indicated by a vertical bar.
2. Loosen the clutch of the hi-hat, allowing it to freely move up and down the pull rod. Then, let the cymbal rest down on the controller.
3. Tap the **SET** button.
4. Without pushing down on your hi-hat pedal, raise the cymbal to the preferred height and tighten the clutch. It is recommended to not set the hi-hat cymbal too high with a gap between the cymbal and the hi-hat controller “piston.” Once complete, press the **FINISH** button.
5. Once you have completed the calibration, you may want to fine tune the **Pedal Closed** value, found in the **Advanced** settings for the Hi-hat Trigger Input. This value is critical to getting comfortable with the position where open sounds transition to closed sounds, and how easy it is for you to execute the pedal “splash” and “chick” sounds.

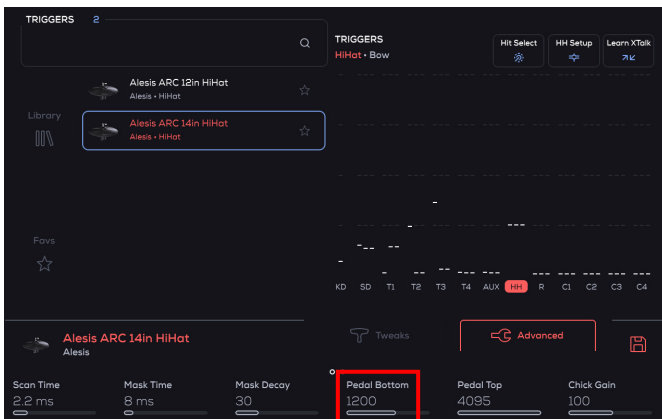
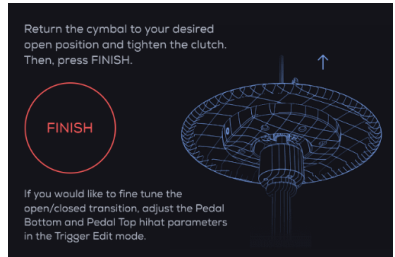

(3.7.4) Trigger Input Tweaks

This section of the Trigger menu allows you to fine-tune each of the trigger input's response based on your style of playing. See the trigger input parameters below that can be adjusted using the **Small Encoders**.

(3.7.4.1) KD (Kick)

Parameter	Description	Value Range
Curve	This determines how a sound's volume is affected by how hard you strike it—that is, how responsive the trigger's dynamics are to changes in your playing.	Linear
		Log 1
		Log 2
		Log 3
		Log 4
		Exp 1
		Exp 2
		Exp 3
		Exp 4
		Spline 1
		Spline 2
		Spline 3
		Spline 4
		Offset
Constant		
Head Sensitivity	Controls how responsive the pad's head is when hit. The higher the value, the less forcefully you need to play to generate a loud hit.	1.0 - 32.0
Head Threshold	This sets at what point a trigger signal is received when a pad is struck above the set velocity. This parameter is useful if you have a nearby speaker or other loud interference which is causing your drum/cymbal to falsely trigger. In the Trigger mode, you can use the signal meters to identify which triggers are receiving the interference, then turn up the Threshold for that Trigger Input until it is removed. Careful! If you turn up the Threshold too high, you will lose the ability to play softer dynamic levels.	1 - 127

(3.7.4.2) SD (Snare), T1-T4 (Toms), Aux

Parameter	Description	Value Range
Curve	This determines how a sound's volume is affected by how hard you strike it—that is, how responsive the trigger's dynamics are to changes in your playing.	Linear
		Log 1
		Log 2
		Log 3
		Log 4
		Exp 1
		Exp 2
		Exp 3
		Exp 4
		Spline 1
		Spline 2
		Spline 3
		Spline 4
		Offset
Constant		
Head Sensitivity	Controls how responsive the pad's head is when hit. The higher the value, the less forcefully you need to play to generate a loud hit.	1.0 – 32.0
Rim Sensitivity	This adjusts the sensitivity of a dual zone drum pad's rim when triggered.	1.0 – 32.0
Head Threshold	This sets at what point a trigger signal is received when a pad is struck above the set velocity. This sets at what point a trigger signal is received when a pad is struck above the set velocity. This parameter is useful if you have a nearby speaker or other loud interference which is causing your drum/cymbal to falsely trigger. In the Trigger mode, you can use the signal meters to identify which triggers are receiving the interference, then turn up the Threshold for that Trigger Input until it is removed. Careful! If you turn up the Threshold too high, you will lose the ability to play softer dynamic levels.	1 – 127
Rim Threshold	This adjusts how hard you have to hit the dual zone pad to generate a sound from the rim. The higher the value, the harder you have to hit it.	1 – 127

(3.7.4.3) HH (Hi-Hat), C1 - C4 (Cymbals)

Parameter	Description		Value Range
Curve	This determines how a sound's volume is affected by how hard you strike it—that is, how responsive the trigger's dynamics are to changes in your playing.		Linear
			Log 1
			Log 2
			Log 3
			Log 4
			Exp 1
			Exp 2
			Exp 3
			Exp 4
			Spline 1
			Spline 2
			Spline 3
			Spline 4
			Offset
Constant			
Bow Sensitivity	n/a	This adjusts the sensitivity for the bow (outer half of the cymbal) to have a higher response with lighter hits.	1.0 - 32.0
Edge Sensitivity	n/a	This adjusts the sensitivity for the edge (rim area, furthest from the center) to have a higher response with lighter hits.	1.0 - 32.0
Threshold	n/a	This sets the minimum trigger velocity required to pass a signal through. Any values below this setting will not be played. This is used to filter out noise/vibrations in the environment, such as if the kit is next to a speaker/subwoofer.	1 - 127

(3.7.5) Trigger Input Advanced Settings

This section of the Trigger menu has advanced parameters to fine-tune each of the trigger input's responses based on your style of playing. See the parameters below that can be adjusted using the **Small Encoders**.

Note: Some parameters have multiple pages. Swipe right on the lower part of the screen to go to the next page; swipe left to go to the previous page.

Note: These Advanced settings are helpful if you want to program a new drum or cymbal trigger from scratch, such as a third-party trigger that is not included as a preset. The Advanced settings are not normally needed for the factory trigger presets.

(3.7.5.1) KD (Kick)

Parameter	Description	Value Range
Scan Time	This specifies the detection time for the trigger signal. Increasing this will increase latency/delay, so the factory presets are set low, and it is not recommended to change them. If you are programming a new trigger, settings that are too low will yield very unpredictable dynamics, and difficulty getting loud hits. Values that are too high may cause difficulty with rimshots, and as mentioned, will increase latency.	0.4 - 15.0 ms
Mask Time	Adjust this to prevent false triggers that occur very soon after the initial trigger, causing a "flamming" sound. Turning this up too high will cause notes to be missed during faster playings or buzz rolls.	1 - 128 ms
Mask Decay	Adjust this in conjunction with the Mask Time to prevent false triggers that happen shortly after the initial trigger (after 20 ms). For example, if you are programming an acoustic drum trigger and the drum it is attached to has a long ringing sound, this setting will help filter false triggers due to the late ringing.	1 - 127

(3.6.5.2) SD (Snare), T1 - T4 (Toms), Aux

Parameter	Description	Value Range
Scan Time	This specifies the detection time for the trigger signal. Increasing this will increase latency/delay, so the factory presets are set low, and it is not recommended to change them. If you are programming a new trigger, settings that are too low will yield very unpredictable dynamics, and difficulty getting loud hits. Values that are too high may cause difficulty with rimshots, and as mentioned, will increase latency.	0.4 - 15.0 ms
Mask Time	Adjust this to prevent false triggers that occur very soon after the initial trigger, causing a "flamming" sound. Turning this up too high will cause notes to be missed during faster playings or buzz rolls.	1 - 128 ms
Mask Decay	Adjust this in conjunction with the Mask Time to prevent false triggers that happen shortly after the initial trigger (after 20 ms). For example, if you are programming an acoustic drum trigger and the drum it is attached to has a long ringing sound, this setting will help filter false triggers due to the late ringing.	1 - 127
Zone Balance	This determines the balance between head hits and rim hits. This should generally not need to be adjusted for factory presets, although if you tune your mesh drum heads very low, it may need adjustment. Lower values will favor head hits, and higher values rim hits.	-64 - 63
Rim Balance	When playing on the rim, this will adjust the balance between a rimshot sound and a rim click or cross-stick sound. Lower values will make rimshots easier and more likely, and higher values will make rim clicks more likely. For the factory presets, this is preferential and based on your technique. For example, some may prefer to only get rimshot sounds on the rim, which can be achieved by turning this value all the way up.	-64 - 63
XTalk Decay	This helps to remove false triggers that occur when you hit one zone, and shortly after, a nearby zone is falsely triggered. For example, if your drum has a loose tension rod which is rattling, hitting the mesh head may result in a false trigger later on the rim. While you should fix this by tightening the tension rod, this would be an example of using XTalk Decay. Again, this is an advanced parameter that generally does not need to be adjusted unless you are programming a new 3rd party trigger from scratch.	0 - 127

(3.7.5.3) HH (Hi-Hat)

Parameter	Description	Value Range
Scan Time	This specifies the detection time for the trigger signal. Increasing this will increase latency/delay, so the factory presets are set low, and it is not recommended to change them. If you are programming a new trigger, settings that are too low will yield very unpredictable dynamics, and difficulty getting loud hits. Values that are too high may cause difficulty with rimshots, and as mentioned, will increase latency.	0.4 - 15.0 ms
Mask Time	Adjust this to prevent false triggers that occur very soon after the initial trigger, causing a “flamming” sound. Turning this up too high will cause notes to be missed during faster playings or buzz rolls.	1 - 128 ms
Mask Decay	Adjust this in conjunction with the Mask Time to prevent false triggers that happen shortly after the initial trigger (after 20 ms). For example, if you are programming an acoustic drum trigger and the drum it is attached to has a long ringing sound, this setting will help filter false triggers due to the late ringing.	1 - 127
Pedal Bottom	Important: This is an important adjustment for the playability of your hi-hat. It determines the point at which the hi-hat’s open sounds transition to closed sounds, and also where the “chick” or “splash” sounds are started. Higher settings will make the “chick” or “splash” sounds more sensitive, but may also make closed/open hi-hat patterns more difficult to play. Lower settings will make closed/open patterns more realistic, but going too low will make the “chick” and “splash” more difficult.	100 - 2048
Pedal Top	This will generally not need adjustment after the hi-hat calibration is completed. This determines where the fully open hi-hat sound will play. Adjusting this will subtly affect how easy it is to get the various semi-open hi-hat sounds reliably.	2048 - 4095
Chick Gain	Adjust the volume sensitivity of the pedal ‘chick’ technique.	0 - 200
Splash Sensitivity	Controls how responsive the “splash” effect is when you hit the pedal. To create this sound, tap your foot on the pedal and lift it up immediately. Higher values will generally require your splash to be quicker, while lower settings will be a bit more forgiving to your technique.	2.6 - 1638.2
Splash Gain	Adjust the volume sensitivity of the pedal ‘splash’ technique.	0 - 200

Parameter	Description	Value Range
Choke Time	Sets the minimum time you must grab and hold the edge of a cymbal in order for it to register a cymbal choke/mute. Lower values will make it easier to choke, but may also cause unintended chokes from your drumstick. Values that are too high may cause an uncomfortable delay from the moment of grabbing the cymbal until the choke occurs.	1 - 200 ms
Invert Bell & Edge	Swaps the trigger input for the bell and the edge. This setting is only needed with certain cymbal pad brands.	Off, On
Edge Decay Boost	Provides an extra false trigger filter decay for cymbal edges, intended to prevent any false triggers due to the cymbal swinging on the stand. This is only required if you get very late false triggers after a very hard cymbal crash. Generally, this shouldn't need to be adjusted.	0 - 100

(3.7.5.4) R (Ride), C1 - C4 (Cymbals)

Parameter	Description	Value Range
Scan Time	This specifies the detection time for the trigger signal. Increasing this will increase latency/delay, so the factory presets are set low, and it is not recommended to change them. If you are programming a new trigger, settings that are too low will yield very unpredictable dynamics, and difficulty getting loud hits. Values that are too high may cause difficulty with rimshots, and as mentioned, will increase latency.	0.4 - 15.0 ms
Mask Time	Adjust this to prevent false triggers that occur very soon after the initial trigger, causing a "flamming" sound. Turning this up too high will cause notes to be missed during faster playings or buzz rolls.	1 - 128 ms
Mask Decay	Adjust this in conjunction with the Mask Time to prevent false triggers that happen shortly after the initial trigger (after 20 ms). For example, if you are programming an acoustic drum trigger and the drum it is attached to has a long ringing sound, this setting will help filter false triggers due to the late ringing.	1 - 127
Edge Decay Boost	Provides an extra false trigger filter decay for cymbal edges, intended to prevent any false triggers due to the cymbal swinging on the stand. This is only required if you get very late false triggers after a very hard cymbal crash. Generally, this shouldn't need to be adjusted.	0 - 100
Choke Time	Sets the minimum time you must grab and hold the edge of a cymbal in order for it to register a cymbal choke/mute. Lower values will make it easier to choke, but may also cause unintended chokes from your drumstick. Values that are too high may cause an uncomfortable delay from the moment of grabbing the cymbal until the choke occurs.	1 - 200 ms
Invert Bell & Edge	Swaps the trigger input for the bell and the edge. This setting is only needed with certain cymbal pad brands.	Off, On

(3.7.6) Stacks

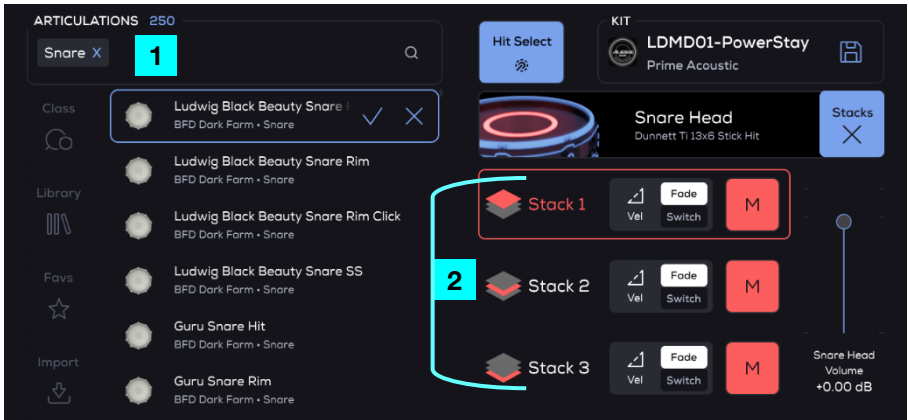

The Stacks allows you to layer up to three extra sounds/articulations on top of the main Kit Piece sound. You can also browse and load individual sounds or articulations (for example, Ludwig 14x5 Snare Rimshot) directly to an individual Trigger Zone (such as Snare Center or Snare Rim).

1. Articulation Browser

While the Edit default mode deals with Kit Pieces (collections of Articulations), the Stacks mode deals with all the individual Articulations. All searching/filtering features are the same, but the content in the browser will just show Articulations.

Example:

- **Kit Piece:** Ludwig Acrolite 14" Acro Snare
 - **Articulations:**
 - Ludwig Acrolite 14" Snare On Hit
 - Ludwig Acrolite 14" Snare On Rim
 - Ludwig Acrolite 14" Snare On Rim Click
 - Ludwig Acrolite 14" Snare On SS

2. Stack 1-3

Select the Stack to be edited by tapping this object, which includes an image of the currently loaded Articulation or Kit Piece. The parameter carousel represents the parameters for the articulation of the stack, NOT the main kit piece.

To create layered kit pieces (multiple sounds stacked on each other):

1. From **Edit mode**, tap the **Stacks** option.
2. Tap to enable to **Hit Select** function.
3. Hit a drum to jump to that trigger input.
4. Tap a Stack number and select the Articulation you want to assign to that stack from the browser list.
5. Tap the checkmark or press the **Main Encoder** to assign the Articulation to the stack. Repeat this for each of the stacks.

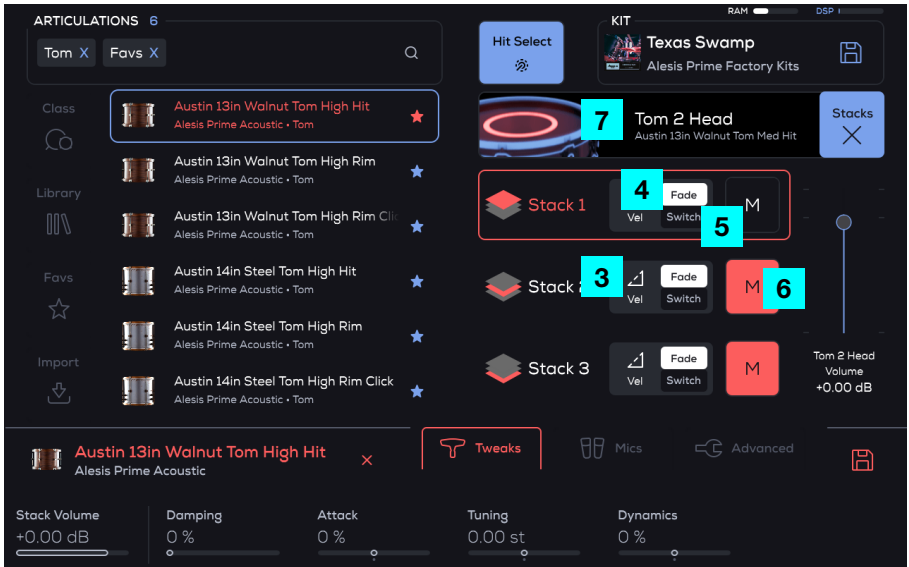

3. Velocity Threshold

Tap to open and set the MIDI Velocity value with the slider (0-127).

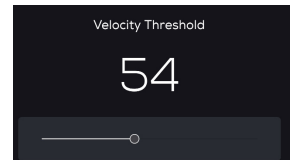

4. Fade

The Stack will begin playback starting at the set MIDI Velocity Threshold and change the audio playback volume dynamically up to 127. If the slider is set to 0 (leftmost), the audio playback is unchanged from the original state. If the slider is set to 127 (rightmost), the Stack will play at velocity 127 at normal playback volume.

5. Switch

This is the same as Fade except that the Stack does not sound until the slider value is reached, then it will begin playback dynamically as normal. If you set the slider to 0, audio playback is unchanged from the original state. If you set the slider to 127, the Stack will play at velocity 127 at normal playback volume.

6. Mute

Tap to mute the selected Stack.

7. Trigger Zone

This graphically shows which Trigger Zone is currently selected. All drums have head, rimshot, and rim only. All cymbals have bow, edge, and bell zones. The Hi-hat has bow, edge, bell, and pedal zones. It also shows the articulation assigned to the main kit piece for that zone (the darker/smaller grey text below the zone name).

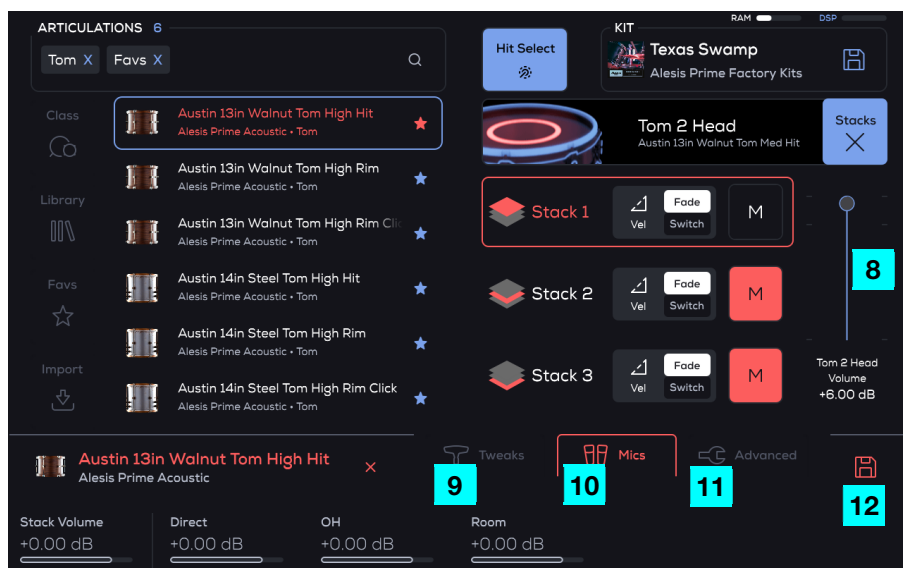

8. Main Kit Piece Articulation Volume

Use the touch slider to adjust the volume of the Articulation assigned to the main Kit Piece (-INF - 0.00 - +6.00 dB). For example, if you want to assign a cowbell layer to the snare rim and only want the cowbell to sound (not mixed with the original rim sound), turn this slider all the way down.

9. Tweaks

This shows various sample playback parameters that can be adjusted using the **Small Encoders**.

10. Mics

This shows the individual mic channels, which are adjusted using the **Small Encoders**, and how much of the channel is sent to the Mixer.

11. Advanced

This shows more advanced tone and sample playback settings that can be adjusted using the **Small Encoders**.

12. Save

Save a copy of the current preset or user kit piece to your user library.

(3.8) USB Recording

If you connect a USB cable (sold separately) from the PRIME drum module's rear panel **USB-B Port** to a USB port on your computer, you'll be able to use your DAW software to record your performance (MIDI data) from the PRIME drum module.

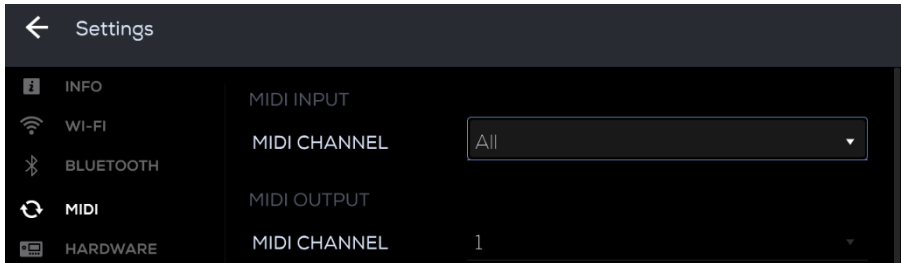

PRIME uses 16 channels for the USB MIDI output. Select **PRIME Drum Module MIDI** as the MIDI output device in your DAW.

To record MIDI data from PRIME to your computer's DAW:

1. Use a USB cable (sold separately) to connect the **USB-B Port** on the module to a USB port on your computer.
2. Open your sequencer software.
3. In your software's MIDI setup options, select **PRIME Drum Module MIDI** as the MIDI input device.
4. Create a MIDI track in the DAW and set the MIDI track's MIDI channel to the same channel in PRIME's **Settings > MIDI > MIDI Output > MIDI Channel**.
5. Record arm your MIDI track in your software and start recording.

(4.0) Settings

Use the Settings menu to configure the PRIME drum module's overall operation.

To show the settings, press the **Kit** button and then tap **Settings** on the right edge of the screen.

To switch through each tab of the settings, tap the tabs along the left edge of the screen.

(4.1) Info

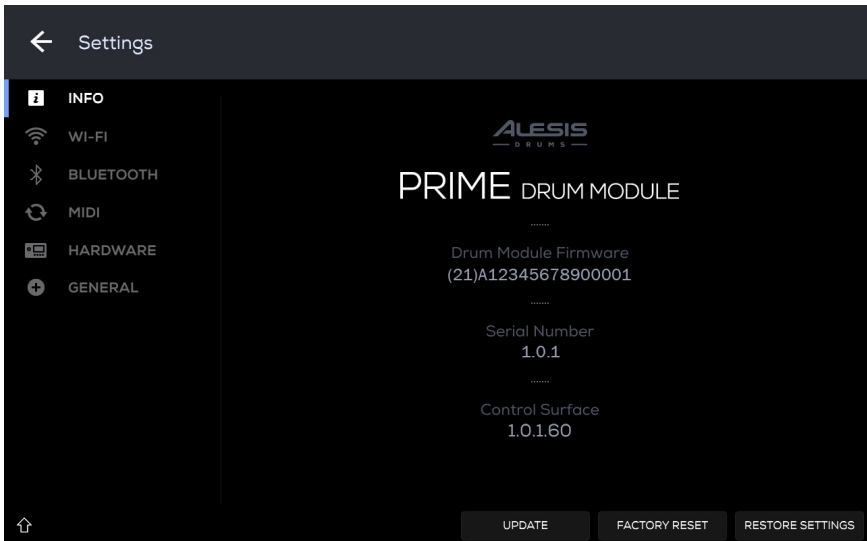

On this tab you can view the PRIME drum module's current **Firmware** version, access PRIME's **Serial Number**, as well as the **Control Surface** number. This menu also allows you to update PRIME's firmware and perform a factory reset. Press the **Up arrow** in the bottom-left corner to see Credits, Legal Info, and Version Info.

Update: Press to update your module to the latest available firmware. Select **Online Update** to download an available update through your connected Wi-Fi network. Select **USB Drive Update** to download a firmware update that you have manually downloaded from alesis.com. Select **Switch to Update** to install the update from a USB connection to your computer.

Factory Reset: Press to restore the module to a new out-of-box state.

Important: A reset will permanently erase all of your User Content (Kits, Kit Pieces, Samples, etc.).

Restore Settings: Press to reset your module's default settings, including Wi-Fi network connections.

(4.2) WI-FI

PRIME features an integrated **Wi-Fi connection**, enabling you to connect PRIME to a local network so that you can receive new **firmware updates**.

To connect PRIME to your local Wi-Fi network, tap the **ON** button at the top of the screen. Then, tap the local network that you would like to connect to. Tap the **CONNECT** button and enter the password for the network when prompted.

To disconnect PRIME from your local network, tap the **DISCONNECT** button.

To forget the Wi-Fi network, tap the **FORGET** button.

To disable Wi-Fi, tap the **OFF** button.

Press the **Up arrow** in the bottom-left corner to get Info for your connected Wi-Fi network such as IP Address, Security, and Wi-Fi Strength.

(4.3) Bluetooth

PRIME features an integrated **Bluetooth connection**, enabling you to connect to a supported MIDI or audio device.

To enable Bluetooth for pairing to your MIDI or audio device, tap the **ON** button at the top of the screen. Select your Bluetooth device from the list of **AVAILABLE DEVICES** and select **PAIR**. Then, search for "PRIME Drum Module" in the Bluetooth Settings menu on your device and connect to it.

To connect to a previously paired Bluetooth device, tap the device's name in the list of **PAIRED DEVICES** and tap the **CONNECT** button.

To disconnect a paired Bluetooth device, tap the device's name in the list of **PAIRED DEVICES** and tap the **DISCONNECT** button.

To have PRIME forget a previously connected device, tap the device's name, and then tap **REMOVE**.

(4.4) MIDI

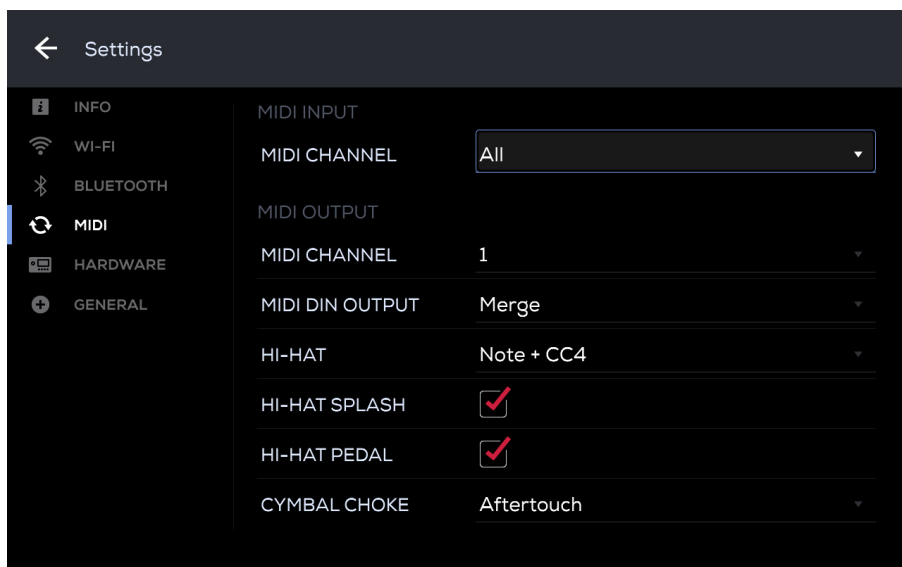

These settings determine how the PRIME drum module sends and receives MIDI information to and from external devices.

MIDI Input

MIDI Channel: This setting determines the MIDI channel(s) that PRIME will receive MIDI messages. Tap this field and turn the **Main Encoder** to select from channels 1-16, or All.

MIDI Output

MIDI Channel: This setting determines the MIDI channel(s) that PRIME will send MIDI messages. Tap this field and turn the **Main Encoder** to select from channels 1-16.

MIDI DIN Output: **Merge** (both kit and MIDI input signals will pass to the MIDI DIN output), **Kit Only** (Kit MIDI signals are only sent to the MIDI DIN output), **Input Thru** (MIDI DIN input signals are only sent to the MIDI DIN output).

Hi-Hat: Change this field to have the hi-hat send **Note+CC4** to transmit the MIDI note for the hi-hat and pedal aftertouch messages. Select **Note + CC10** to transmit the MIDI note for the hi-hat and the Pan left/right balance setting for the sound.

Hi-Hat Splash: This setting determines whether or not the hi-hat “splash” note (generated by quickly pressing then releasing the pedal) will be sent.

Hi-Hat Pedal: This setting determines whether or not the hi-hat “chick” note (generated by quickly pressing then releasing the pedal) will be sent.

Cymbal Choke: Select **Note** to have the pad send a specified note for a choke message. Select **Aftertouch** to send a polyphonic aftertouch event for a choke message. Select **Off** to not transmit any MIDI data for choke messages.

(4.5) Hardware

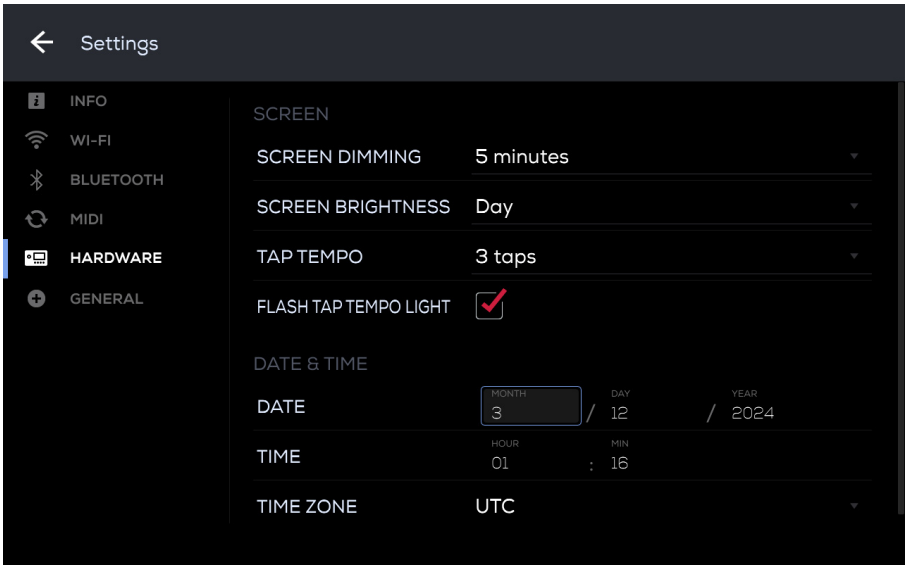

Screen

Screen Dimming: This setting determines how long it will take the screen to dim when it is untouched. Tap this field and select from **Never**, **1**, **2**, **5**, or **10** minutes.

Screen Brightness: This setting determines the brightness of the screen. Select **Day** (Bright) or **Night** (Dim).

Tap Tempo: Select how many taps (**2-4**) it will take to calculate the track's BPM.

Flash Tap Tempo Light: Check this box to have the tap tempo light flash when finding the BPM when using the Tap Tempo feature.

Date & Time

Date: Tap these fields to enter the **Month**, **Day**, and **Year**.

Time: Tap this field to enter the time's **Hour** and **Min**.

Time Zone: Tap this field to enter the time zone. The Time and Day fields will automatically update based on the time zone that is set.

(4.6) General

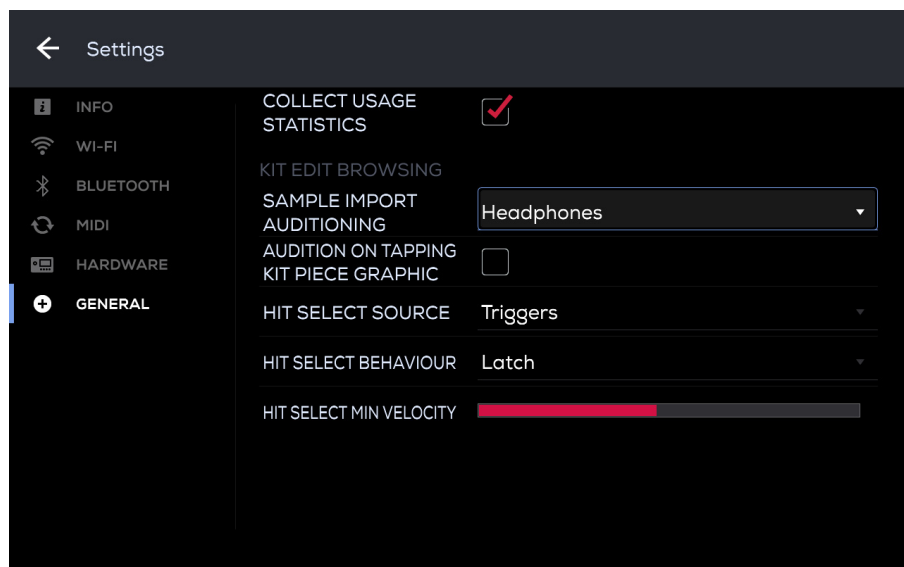

Collect Usage Statistics: Check this box to allow your usage statistics to be sent to us occasionally to improve the PRIME experience.

Kit Edit Browsing

Sample Import Auditioning: Select which output to use when auditioning kits. Select from **Headphones**, **Main**, **Out 3,4**, or **Out 5,6**.

Audition On Tapping Kit Piece Graphic: Tick this box to play the loaded kit piece sound when the kit piece graphic is tapped.

Hit Select Source: Selects whether the input for the Hit Select feature is the **Triggers** or **Triggers and Midi**.

Hit Select Behavior: Select whether the Hit Select feature in Edit mode is set to **Latch** or **Momentary** mode. If set to **Latch**, press and release the **Hit Select** button to turn Hit Select on or off. If set to **Momentary**, press and hold the **Hit Select** button to enable or disable the Hit Select.

Hit Select Min Velocity: Tap the bar and slide with your finger to select the minimum velocity required to trigger the Hit Select feature. **(1-127)**.

(5.0) Troubleshooting

My pad is triggering intermittently.

- Disconnect and reconnect the trigger cable, inserting it securely.
- Adjust the Head Sensitivity and Threshold settings in **Edit Mode > Tweaks**.

I can't hear sound when I trigger a pad.

- Make sure headphones or speakers are connected to PRIME.
- Adjust the **Main** and **Phones** volume knobs.
- Make sure a Kit Piece is assigned to a Trigger Slot. See the section [Edit Mode](#) for more details.
- Confirm that the pad is connected to the correct trigger input.

I can't hear the click.

- Press and hold the **Click** button to open the click menu. Make sure the **Output Volume** is turned up for the output you are monitoring the click through (Main Out 1/2, Headphones, Assign Out 3/4, or Assign Out 5/6).

My hi-hat pedal behaves in an opposite manner.

- Connect the hi-hat pedal first, and then power on PRIME.

My pad is triggering even when no pads are hit.

- Lower the trigger input's gain setting in **Edit mode > Kit Piece Volume**.
- Raise the Threshold setting for the trigger input in **Edit mode > Tweaks**.
- Place the drum kit on a carpet or drum rug to reduce vibration and prevent it from moving.

A pad triggers when another pad is hit.

- Adjust the crosstalk settings to prevent double triggering. Refer to the [Learn XTalk](#) section for more details.

Some sounds are louder than others.

- In Edit mode, adjust each **Kit Piece Volume**.
- In Mix mode, adjust the volume mixes for each output assignment.

The cymbal is not sending a choke MIDI message.

- Make sure you are triggering a dual zone cymbal and not a single zone cymbal.
- In the **Settings** menu > **MIDI** tab > **Cymbal Choke**, select **Note** to send a specified MIDI note for a choke message. Select **Aftertouch** to send a polyphonic aftertouch event for a choke message.

(6.0) Appendix

(6.1) Kit List

1	NY Maple Kit	28	Dark Power 1
2	Artist Birch Raw 1	29	Binary Cleanse
3	Copper Kit 1	30	Cali Maple 1
4	Texas Special	31	Artist Birch Proc 2
5	Deep Dark Birch	32	NY Maple Thud
6	Acrylic Raw 1	33	Vintage Kit 2
7	Cali Maple 2	34	Perc Work 2
8	Big and Mean	35	Texas Walnut 2
9	Texas Swamp	36	Artist Birch Proc 3
10	Combo Kit 3	37	NY Maple Rods
11	Tight Copper	38	Deep Birch
12	Perc Work 1	39	Son of Silence
13	Tight Beech	40	Texas Walnut 1
14	Artist Birch Proc 1	41	Groove 1
15	CDD Class	42	Bubs Brushes
16	Son of a Brush	43	Combo Kit 1
17	Copper Kit 2	44	Dark Roomy Kit 1
18	That Alesis DnB	45	NY Maple Open
19	Phased Breaks	46	Tight Acrylic
20	Fat Kit	47	Mahogany Kit 1
21	Son of Rock	48	Acrylic Raw 3
22	Beef Stacks	49	Tight Steel
23	Texas Chainsaw	50	Hip Hop
24	Combo Kit 2	51	Dark Roomy Kit 2
25	Roto Kit	52	Tight and Low
26	NY Maple Proc 1	53	Tight and Weird
27	Acrylic Raw 2	54	Billy Zeppelin

55	Ambient Digital Ghosts
56	Copper Kit 3
57	Crawl
58	Dark Roomy Kit 3
59	Vintage Kit 1
60	Electro1
61	Electro2
62	Harder Rock
63	Hybrid Jazzer
64	Combo Kit 4
65	Mahogany Kit 2
66	Midwest Romance
67	Power Mono Kit 1
68	Power Mono Kit 2
69	Renegade Farm
70	Rosetta Thule
71	Smack Brains
72	Steel Kit
73	Mahogany Kit 3
74	Dark Roomy Kit 4
75	Empty Kit

(6.2) MIDI Mapping

Trigger Input	Trigger Zone	MIDI Note
Kick	Head	24 C1
Snare	Head	26 D1
	Rimshot	29 F1
	Cross Stick	25 C#1
	Rim Only	88 E6
Tom 1	Head	38 D2
	Rimshot	70 A#4
	Rim Only	93 A6
Tom 2	Head	35 B1
	Rimshot	66 F#4
	Rim Only	91 G6
Tom 3	Head	31 G1
	Rimshot	61 C#4
	Rim Only	89 F6
Tom 4	Head	33 A1
	Rimshot	63 D#4
	Rim Only	90 F#6
Aux	Head	40 E2
	Rimshot	73 C#5
	Rim Only	94 A#6
HiHat	Bow	18 F#0
	Edge	20 G#0
	Bell	22 A#0
	Pedal	32 G#1
	Splash	56 G#3

Trigger Input	Trigger Zone	MIDI Note
Ride	Edge	50 D3
	Bow	60 C4
	Bell	71 B4
	Choke	87 D#6 and aftertouch - 127 hold, 0 release
Cymbal 1*	Edge	41 F2
	Bow	52 E3
	Bell	62 D4
	Choke	75 D#5 and aftertouch - 127 hold, 0 release
Cymbal 2*	Edge	45 A2
	Bow	55 G3
	Bell	65 F4
	Choke	80 G#5 and aftertouch - 127 hold, 0 release
Cymbal 3*	Edge	43 G2
	Bow	53 F3
	Bell	64 E4
	Choke	78 F#5 and aftertouch - 127 hold, 0 release
Cymbal 4*	Edge	47 B2
	Bow	57 A3
	Bell	67 G4
	Choke	82 A#5 and aftertouch - 127 hold, 0 release

*** Note:** There are two options for triggering a cymbal choke, set in the **Settings > MIDI** menu. The default option is a specific MIDI Note accompanied by Aftertouch 127 (holding the cymbal) and 0 (release). The other option is to send the MIDI Off note for that particular trigger zone.

(6.3) Technical Specifications

Trigger Inputs	Type: 1/4" (6.35 mm) TRS or TS
Main Outputs	Type: Balanced XLR
Audio Outputs	Type: Impedance-balanced 1/4" (6.35 mm) TRS
Headphone Output	Type: 1/4" (6.35 mm) and 1/8" (3.5 mm) TRS
Power	Input Voltage: 19V 3.42A Center Positive
Dimensions (width x depth x height)	14.05" x 8.97" x 4.09" 357 x 228 x 104 mm
Weight	6.35 lbs. 2.88 kg

Specifications are subject to change without notice.

(6.4) Trademarks & Licenses

Alesis is a trademark of inMusic Brands, Inc., registered in the U.S. and other countries. The *Bluetooth* word mark and logos are registered trademarks owned by Bluetooth SIG, Inc., and any use of such marks by Alesis is under license.

Kensington is a registered trademark of ACCO brands.

SD and SDHC are registered trademarks of SD-3C, LLC.

All other product names, company names, trademarks, or trade names are those of their respective owners.

alesis.com

Manual Version 1.2.1