

IMPORTANT SAFETY INSTRUCTIONS



1. Read these instructions.
 2. Keep these instructions.
 3. Heed all warnings.
 4. Follow all instructions.
 5. Do not use this apparatus near water.
 6. Clean only with a dry cloth.
 7. Do not block any ventilation openings. Install in accordance with manufacturer's instructions.
 8. Do not install near any heat sources such as radiators, registers, stoves, or other apparatus (including amplifiers) that produce heat.
 9. Do not defeat the safety purpose of the polarized or grounding-type plug. A polarized plug has two blades with one wider than the other. A grounding-type plug has two blades and a third grounding prong. The wide blade or third prong is provided for your safety. If the provided plug does not fit into your outlet, consult an electrician for replacement of the obsolete outlet.
 10. Protect the power cord and plug from being walked on or pinched particularly at plugs, convenience receptacles, and the point where it exits from the apparatus.
 11. Only use attachments and accessories specified by Rane.
 12. Use only with the cart, stand, tripod, bracket, or table specified by the manufacturer, or sold with the apparatus. When a cart is used, use caution when moving the cart/apparatus combination to avoid injury from tip-over.
 13. Unplug this apparatus during lightning storms or when unused for long periods of time.
 14. Refer all servicing to qualified service personnel. Servicing is required when the apparatus has been damaged in any way, such as power supply cord or plug is damaged, liquid has been spilled or objects have fallen into the apparatus, the apparatus has been exposed to rain or moisture, does not operate normally, or has been dropped.
 15. The plug on the power cord is the AC mains disconnect device and must remain readily operable. To completely disconnect this apparatus from the AC mains, disconnect the power supply cord plug from the AC receptacle.
 16. This apparatus shall be connected to a mains socket outlet with a protective earthing connection.
 17. When permanently connected, an all-pole mains switch with a contact separation of at least 3 mm in each pole shall be incorporated in the electrical installation of the building.
 18. If rackmounting, provide adequate ventilation. Equipment may be located above or below this apparatus, but some equipment (like large power amplifiers) may cause an unacceptable amount of hum or may generate too much heat and degrade the performance of this apparatus.
 19. This apparatus may be installed in an industry standard equipment rack. Use screws through all mounting holes to provide the best support.
- WARNING:** To reduce the risk of fire or electric shock, do not expose this apparatus to rain or moisture. Apparatus shall not be exposed to dripping or splashing and no objects filled with liquids, such as vases, shall be placed on the apparatus.

NOTE: This equipment has been tested and found to comply with the limits for a Class B digital device, pursuant to part 15 of the FCC Rules. These limits are designed to provide reasonable protection against harmful interference in a residential installation. This equipment generates, uses and can radiate radio frequency energy and, if not installed and used in accordance with the instructions, may cause harmful interference to radio communications. However, there is no guarantee that interference will not occur in a particular installation. If this equipment does cause harmful interference to radio or television reception, which can be determined by turning the equipment off and on, the user is encouraged to try to correct the interference by one or more of the following measures:

- Reorient or relocate the receiving antenna.
- Increase the separation between the equipment and receiver.
- Connect the equipment into an outlet on a circuit different from that to which the receiver is connected.
- Consult the dealer or an experienced radio/TV technician for help.

CAUTION: Changes or modifications not expressly approved by Rane Corporation could void the user's authority to operate the equipment.

This Class B digital apparatus complies with Canadian ICES-003.

Cet appareil numérique de la classe B est conforme à la norme NMB-003 du Canada.

WARNING

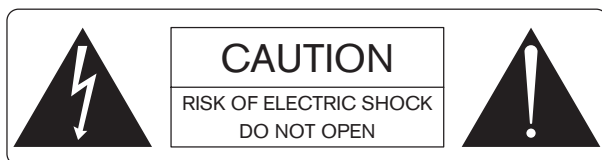

To reduce the risk of electrical shock, do not open the unit. No user serviceable parts inside. Refer servicing to qualified service personnel.

The symbols shown below are internationally accepted symbols that warn of potential hazards with electrical products.



This symbol indicates that a dangerous voltage constituting a risk of electric shock is present within this unit.



This symbol indicates that there are important operating and maintenance instructions in the literature accompanying this unit.

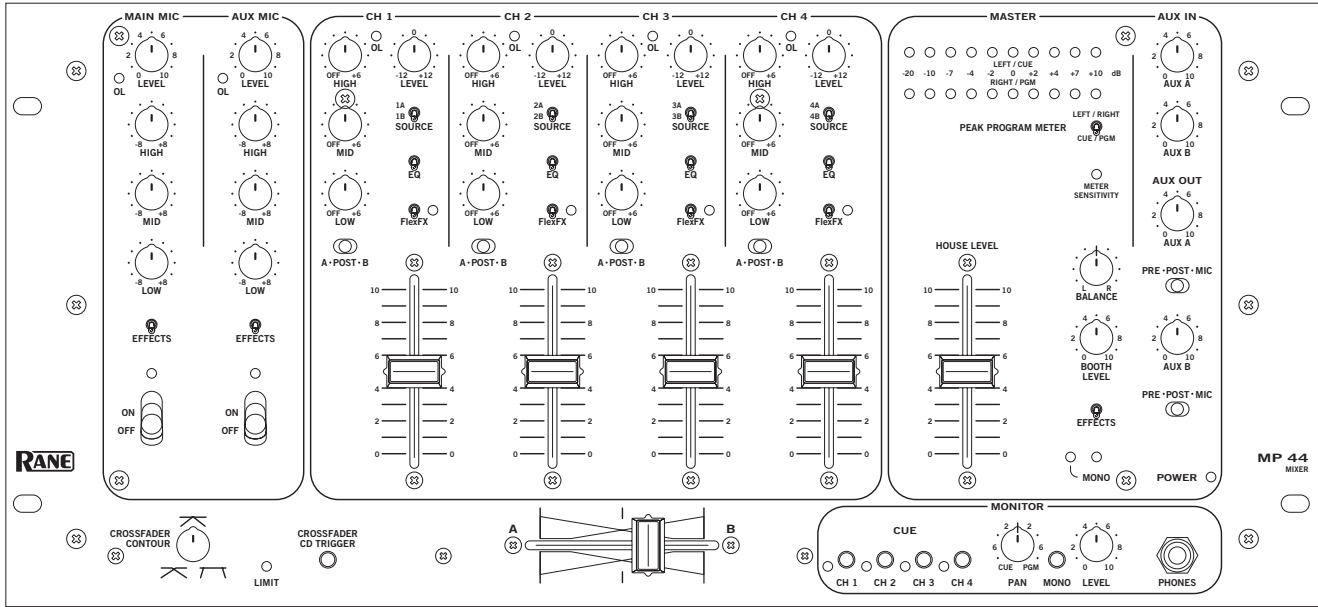

QUICK START

If you have used just about any DJ mixer on the planet, you will instantly feel at home using the MP 44. Extra care was taken to ensure that controls are where you expect them to be, and operate as you expect them to.

The MP 44 has some unique features not found on other DJ mixers. It is important that you read at least this portion of the manual so that you get the maximum benefit from these unique features. As you refer through the rest of this manual (as you should to get the most of it), front panel controls are on the left side of each page, rear panels are on the right.

Club Managers Section

High performance Master Limiter affects both House and Booth signals. This control is located on the rear panel and screw driver adjust to prevent tampering. *The Limiter is a safety net designed to protect ears and equipment.*

Automatic HOUSE PAGE INPUT provides a means to automatically interrupting all program material and broadcast emergency messages at a pre set level. The **HOUSE PAGE GAIN** is set *independent* of **HOUSE-** and **BOOTH LEVEL** control settings. The **HOUSE PAGE GAIN** control is a recessed, screw driver adjusted control located on the rear panel to prevent tampering after installation. See page Manual-6 for more details.

REMOTE LEVEL Control Port provides a means to control the level of the Master mix from a remote location. The range of control is 0 dB to -40 dB. Applications include “gain riding” DJs, setting a comfortable listening level from a remote location and reducing the maximum available gain. To use the optional **VR 1 Remote Control**, simply connect like labeled pins together. Shielded wire is recommended. See page Manual-7 for more details.

WARNING: Do not operate this unit without the line cord earth ground connected. To do so may increase the risk of electric shock and increase line cord conducted emissions.

WEAR PART

This product contains the following wear part subject to the ninety (90) day warranty period described on page Warranty-1: (1) *Active Crossover Assembly.*

DJ Features Section

High performance Master Limiter affects both House and Booth signals. *The Limiter is a safety net designed to protect ears and equipment.* Under normal operating conditions, the **LIMIT** indicator should only flash occasionally. If you are running gains high enough to cause hard limiting, faders and tone controls will not respond as expected. For example, if you run signal levels 10 dB over the Limit threshold, you must turn signal levels down 10 dB before you hear a reduction in level. See page Manual-5 for more details.

3-band Tone Controls with full cut (off to +6 dB) on each of the four Input Buses. You know what to do with this!

FlexFX™ assignment allows any combination of the four Input Buses to be processed by the FlexFX Loop, regardless of A-side, B-side or Post crossfader assignment! See page Manual-3 for details

INPUT CHANNELS

INPUT CH's 1A, 2A, 3A, and 4A are stereo, unbalanced RCA jacks that operate as RIAA equalized Phono Inputs *or* Line Inputs.

PHONO switches set the mode for Inputs **1A, 2A, 3A, and 4A**. In the *out* position, these Inputs operate at line-level (max input +20 dBu). Press the switch *in* for **PHONO** operation. If a turntable is not connected to one of these Inputs, set the switch for Line (*out*).

PHONO GROUND posts are provided for connecting turntable ground wires. It is very important that each turntable have a secure ground connection to the **MP 44**.

INPUT CH's 1B, 2B, 3B, and 4B enter via stereo, line-level, unbalanced RCA jacks. Maximum input level is +20 dBu.

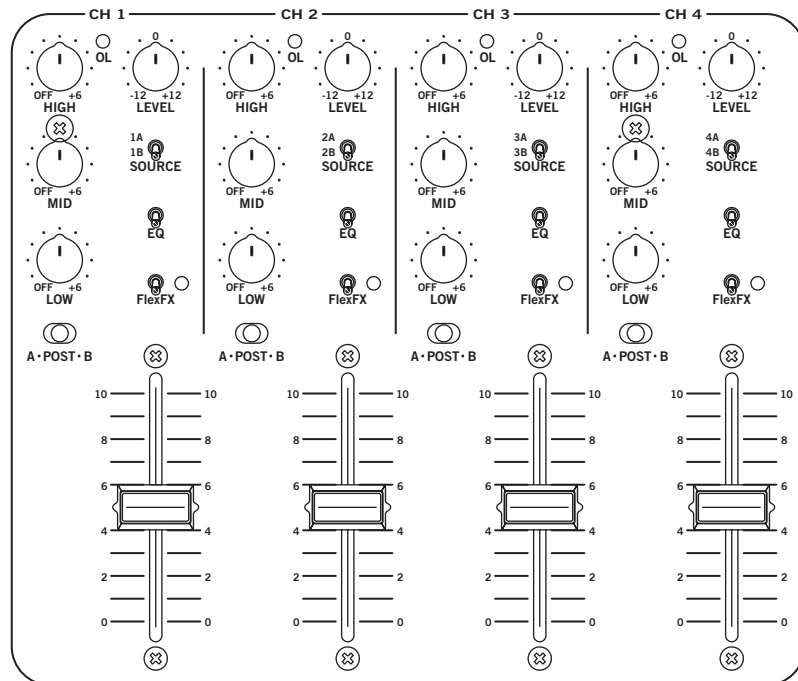

SOURCE switches select **A** (Phono/Line) or **B** (Line) for each Input Channel.

Input **LEVEL** controls adjust the gain from **-12** dB to **+12** dB. The center detent position provides **0** dB of gain (unity). Use this control in conjunction with the **OL** (overload indicator) to set the input gain for the best signal to noise performance.

OL (overload) indicators light when the maximum undistorted signal level has been reached. These are fast responding peak detectors that light 3 dB before clipping. *Adjust Input LEVEL controls so that these indicators remain off.* This ensures that your sound remains clean and undistorted and that adequate head room is reserved for mixing. The **OL** indicators are *not* beat matching indicators.

EQ switches engage the 3-band tone controls. **EQ** switches may be used in conjunction with the **Hi**, **Mid** and **Low** rotary tone controls as “kill” switches. Set the rotary controls and flip the switch.

HIGH tone controls affect frequencies from 4 kHz to 20 kHz. The range of control is **+6** dB to **OFF** (full kill). The center detent position is unity gain. These controls are positioned just above the vocal range and may be used for small tonal changes or for the elimination of high frequency signals.

MID tone controls affect frequencies from 300 Hz to 4 kHz. The range of control is **+6** dB to **OFF** (full kill). The center detent position is unity gain. These controls may be used for small tonal changes or for the elimination of midrange signals.

LOW tone controls affect frequencies from 20 Hz to 300 Hz. The range of control is **+6** dB to **OFF** (full kill). The center detent position is unity gain. These controls influence signals below midrange vocals and may be used for small tonal changes or for the elimination of bass and beats.

A – POST – B switches independently assign **CH 1, CH 2, CH 3** or **CH 4** to the **A** side of the crossfader, **B** side of the crossfader or **POST** (after) the crossfader. The ability to assign an Input Channel to the *desired mix* eliminates the need for *redundant* source selection on each of the four input channels.

Input **Channel Faders** control the mix level for each of the 4 input channels. These are VCA control faders for extended service life and reduced travel noise. To achieve the best mix consistency, use input **LEVEL** controls to set the gain and **Channel Faders** to control the mix.

FlexFX™



FlexFX™ switches independently assign *any combination* of the four Input Channels to the FlexFX Loop for external processing. FlexFX assignment is *totally independent* of **A – POST – B** mix assignment. You'll get more out of your favorite external effects box than you ever thought possible, and experiment with this feature for a long time to come. The indicator illuminates when FlexFX is active on it's Channel.

FlexFX SEND jacks are unbalanced ¼" Tip/Sleeve Outputs. The maximum output level is reduced to +16 dBu to accommodate the inputs on lower voltage external effects processors. All Input Channels assigned to the FlexFX loop are *removed from the direct mix*, summed together by the FlexFX summer and output on this stereo pair of jacks.

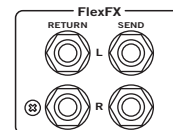

FlexFX RETURN jacks are unbalanced ¼" Tip/Sleeve Inputs. This stereo pair of jacks provide the return input from the external processor's output. This Input provides 6 dB of gain to accommodate lower voltage external processors. The maximum input level is +16 dBu. The FlexFX return signal is summed with the direct signals to form the Left / Right mix.

ACTIVE CROSSFADER™

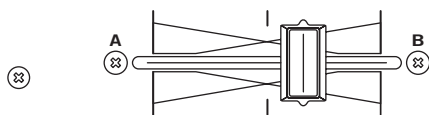

The MP 44 features a high-performance *Active Crossfader*. In addition to low travel noise and long fader life, the design provides the accuracy and consistency required by the most demanding Turntablist. The continuously adjustable **CROSSFADER CONTOUR** control provides smooth and consistent crossfader response adjustment. Control ranges from the “constant power” response required for smooth blends to fast cut. This crossfader design accommodates all mixing styles.

The **CROSSFADER CD TRIGGER** switch enables the **CD TRIGGER** outputs which are ⅛" mini TRS jacks. CD stop pulses are output on the Sleeve. CD start pulses are output on the Tip. The ring is unused. Ground return is via the CD player RCA signal cables. The automatic CD trigger circuit monitors the position of the Crossfader. When the Crossfader moves to full cut (0) for the **A** side, **CD TRIGGER 1** outputs a 50 ms, active low *stop* pulse. When the crossfader moves just above full cut for the **A** side mix, **CD TRIGGER 1** outputs a 50 ms, active low *start* pulse. The same operation is true for the **B** side of the crossfader and **CD TRIGGER 2**.



Fader Cleaning

With heavy use in harsh environments, the faders may need lubrication. This treatment extends longevity and can make used faders as good as new. The fader assembly must be removed from the MP 44 for proper cleaning. We recommend any of the following cleaning solutions:

Caig DeoxIT FaderLube F100 spray lubricant (www.caig.com)
Caig DeoxIT FaderLube F5 spray cleaner (www.caig.com)
CRC 2-26 (www.crcindustries.com)

Order CaiLube MCL¹ from:
 CAIG Laboratories, Inc.
 12200 Thatcher Ct.
 Poway, CA 92064
 Phone 858-486-8388
 Fax 858-486-8398
(www.caig.com)

CLEANING INSTRUCTIONS

A. Fader assembly replacement (part #11646)

1. Unplug the MP 44.
2. Remove the bottom cover.
3. Remove the fader screws from the front panel.
4. Draw fader assembly out through the bottom.
5. Remove ribbon cable from old fader.
6. Attach ribbon cable to new fader, screw onto front panel and replace bottom cover.

B. Fader cleaning

1. Hold the fader assembly away from the mixer.
2. Position the fader at mid-travel.
3. Spray cleaner/lubricant into both ends of the fader.
4. Move the fader over its full travel back and forth a few times.
5. Shake excess fluid from the fader assembly.
6. Wipe off excess fluid.

AUXILIARY INPUTS & OUTPUTS

Maximum Input and Output signal levels on the AUX jacks is +20 dBu.

AUX IN A is a line-level, unbalanced Input on stereo RCA jacks. **AUX IN A** is summed with the 4 Channel Input mix. **AUX IN A** applications include any unbalanced auxiliary input such as ADAT, VCR, DVD, Video camera, computer audio card, etc.

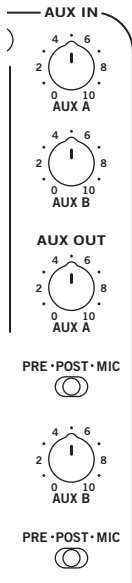
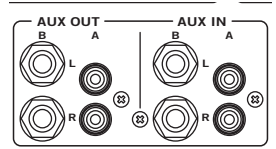

AUX IN B is a line-level, balanced Input on two ¼" TRS jacks. **AUX IN B** is summed with the 4 Channel Input mix. **AUX IN B** is ideal for use with a balanced source located away from the main booth. A good example is a satellite performance mixer for a quest Turntablist.

AUX IN A & B level controls adjust gain from off to +6 dB.

AUX OUT A is a line-level, unbalanced Output on stereo RCA jacks.

AUX OUT B is a stereo, line-level, balanced output. The jacks are ¼" TRS.

AUX OUT A & B level controls adjust gain from off to +6 dB.

AUX OUT A, **PRE • POST • MIC** switch sets **AUX OUT A** source to **PRE**-Master-Effects-loop, **POST**-Master-Effects-Loop *or* Post-Master-Effects-Loop-plus-**MIC**. Source selection and level control give **AUX OUT A** the versatility to accommodate applications ranging from recording to additional Zone Output.

AUX OUT B **PRE • POST • MIC** switch sets **AUX OUT B** source to **PRE**-Master-Effects, **POST**-Master-Effects *or* Post-Master-Effects-plus-**MIC**. Source selection and level control give **AUX OUT B** the versatility to accommodate applications ranging from recording to additional Zone output.

MASTER MIX PROCESSING

The **MASTER** mix is the point at which all input signals (**CH 1 – CH 4**, **AUX A**, **AUX B**, **MAIN MIC** and **AUX MIC**) are summed together to form *one stereo signal*.

MASTER signal processing includes the **MASTER EFFECTS** loop, **REMOTE LEVEL** control, **MASTER LIMIT**, system **MONO**, system **BALANCE**, **LIGHT TRIGGER** and **EMERGENCY PAGE**.

All **MASTER** signal processing influences **HOUSE** and **BOOTH** Outputs equally. The **MASTER** mix is then split into **HOUSE** and **BOOTH** Outputs.

Maximum Input and Output signal levels on **MASTER EFFECTS** jacks is +20 dBu.

MASTER EFFECTS SEND is an unbalanced Output on ¼" Tip/Sleeve jacks. This Output sends signal to any external processing, including EQ, dynamic range control, special effects, etc. The **MASTER** signal is always present at this Output.

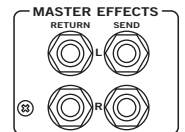

MASTER EFFECTS RETURN is an unbalanced Input on ¼" Tip/Sleeve jacks. This Input receives the signal from the external processor. These are switching jacks—if no external connection is made to the jacks, the **MASTER EFFECTS SEND** signal is internally connected to the **MASTER EFFECTS RETURN**.

The **MASTER EFFECTS** switch enables the **MASTER EFFECTS** loop. As stated above, if an external connection is not made to the **RETURN** jacks, the **MASTER EFFECTS** switch has no effect.

The **REMOTE LEVEL** port provides a means to control the level of the **MASTER** mix from a remote location. The range of control is 0 dB to –40 dB. Applications include "gain riding" DJs, setting a comfortable listening level from a remote location and reducing the maximum available gain. See **VR 1 Remote Level Control** on page Manual-7 for hookup details.

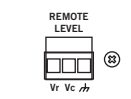

The **LIMIT** threshold control sets the maximum allowable **MASTER** signal level. The Limiter affects both House and Booth signals. *This control is located on the rear panel and screw driver adjust to prevent tampering.* Threshold range is **-20** dBu to **+20** dBu. Center detent is **0** dBu. **LIMIT** threshold indicators are located on the front and rear panels.



Only 6 dB of post limiter makeup gain is available. To set the maximum system level, adjust the Limiter with **HOUSE** and **BOOTH LEVEL** controls set to maximum. Applications include limiting SPL, protecting amplifiers and speakers.

A note to DJs: If you are running gains high enough to cause hard limiting, faders and tone controls will not respond as expected. For example, if you run signal levels 10 dB over the Limit threshold, you must turn signal levels down 10 dB before you hear a reduction in level. *The Limiter is a safety net designed to protect ears and equipment.* Under normal operating conditions, the **LIMIT** indicator should only flash occasionally.

MASTER HOUSE & BOOTH OUTPUTS

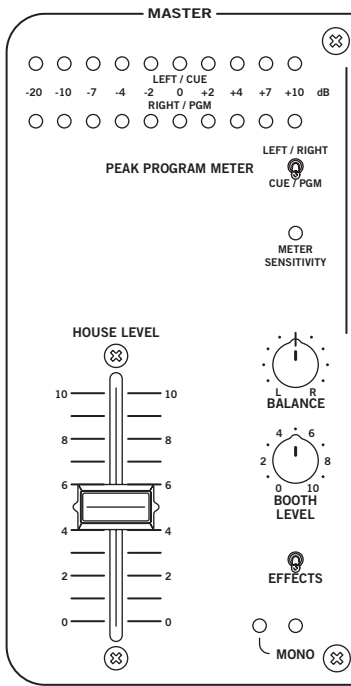

The **PEAK PROGRAM METER** has two modes of operation. In **LEFT / RIGHT** mode (*up*) the meter indicates *House Output* level. In **CUE / PGM** mode (*down*), the top half of the meter shows the mono *CUE* level and the bottom half mono *MASTER* level. Set for **CUE / PGM**, you can see the relative beat and level of the Master mix and Cue signals.

The **PEAK PROGRAM METER** has two sensitivity settings. Push the recessed **METER SENSITIVITY** switch *in* so that 0 dB = +4 dBu (less sensitive). Set the switch to the *out* position so that 0 dB = -10 dBV (more sensitive). The meter is peak responding with a 1 second peak hold.

MASTER HOUSE LEVEL & BOOTH LEVEL faders are VCA controlled for extended service life and reduced travel noise.

The **MASTER BALANCE** control determines the left/right balance of the **MASTER** mix. The control influences both **HOUSE** and **BOOTH** Outputs.

The **MASTER MONO** switch is a recessed front panel switch used to set **HOUSE** and **BOOTH** Outputs for mono operation. The Green **MONO** indicator lights when the **MONO** switch is engaged.

HOUSE OUTPUT jacks give you two choices. The XLR Outputs have a maximum signal level of +20 dBu, and are the preferred connection to equalizers, crossovers or power amplifiers. The unbalanced RCA outputs have a maximum signal level of +16 dBu. Do not drive unbalanced cables longer than 10 feet (3 meters). 6 feet (2 meters) or shorter is recommended. Both types may be used simultaneously

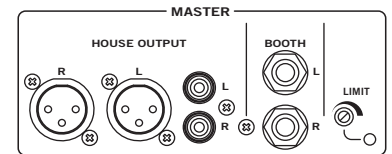

BOOTH outputs are balanced ¼" TRS Outputs with a maximum signal level of +20 dBu.

HEADPHONE MONITOR

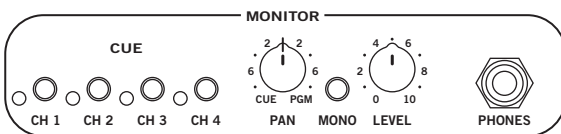

MONITOR controls determine the source and level of the **PHONES** signal. With the **MONITOR MONO** switch *out*, the **PAN** control fades between stereo **CUE** and stereo **PGM** signals. The **CUE** signal is selected using **CUE CH 1**, **CH 2**, **CH 3** and **CH 4** switches in any combination. The associated yellow indicator lights when a **CUE** is active. The **PGM** signal monitors the **HOUSE** Output (same signal going to the Master House).

With **MONITOR MONO** selected (*in*), the **PAN** control fades between mono **CUE** (left ear) and mono **PGM** (right ear).

PAGING

The **HOUSE PAGE INPUT** provides a means to automatically interrupt all program material, and broadcast emergency messages at a preset level. The **HOUSE PAGE INPUT** jack is a balanced 3-pin Euroblock. The Input is line-level with a maximum signal level of +20 dB. When an input signal greater than -20 dBu is sensed, **HOUSE** and **BOOTH** levels automatically attenuate 40 dB and the **HOUSE PAGE INPUT** signal routes to both **HOUSE** and **BOOTH** Outputs. The **HOUSE PAGE INPUT GAIN** is set *independent* of **HOUSE** and **BOOTH LEVEL** settings. This control is a recessed, screw driver adjusted control located on the rear panel to prevent tampering after installation.

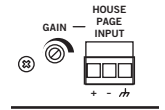

MIC INPUTS

Both **MAIN** and **AUX MIC** Inputs operate separately but identically. The maximum input and output levels for the **EFFECTS** loops is +20 dBu.

MAIN & AUX MIC INPUTS are balanced with combination XLR / 1/4" TRS jacks. The maximum input level is +4 dBu. The **MAIN MIC GAIN** range is +15 dB to +60 dB, and has a **PHANTOM POWER** switch to select +12 volt phantom power. The **AUX MIC** is switchable **MIC** or **LINE** level. It has a **GAIN** control range of +30 to +60 dB in **MIC** mode. In **LINE** mode, the maximum input is +20 dBu with a **GAIN** control range of 0 to +30 dB. Use the **GAIN** control in conjunction with the **OL** indicator (see below) to set the correct gain.

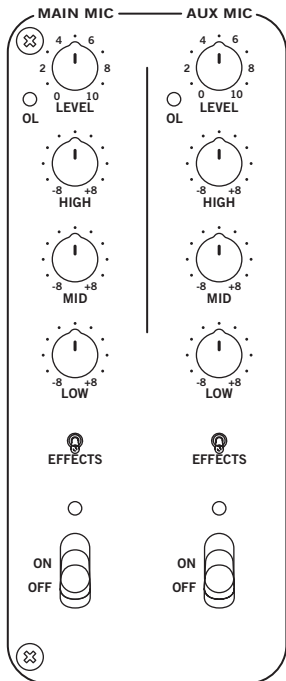
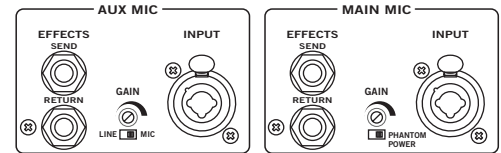

MAIN & AUX MIC EFFECTS SENDS are unbalanced mono Outputs on 1/4" Tip/Sleeve jacks. This Output is used for external processing, including EQ, dynamic range control, special effects boxes, etc. The **MAIN** or **AUX MIC** signals are always present on each of these respective Outputs.

MAIN & AUX MIC EFFECTS RETURN are unbalanced mono Inputs on 1/4" Tip/Sleeve jacks. This Input receives the signal from an external processor. This is a switching jack—if no external connection is made to the jack, the **EFFECTS SEND** signal is internally connected to its own **EFFECTS RETURN**.

MAIN & AUX MIC LEVELS are full-range controls used to set the desired level of each mic.

OL (overload) indicators light 3 dB before clipping. The signal level is monitored both pre- and post-tone control. Adjust the rear panel Input **GAIN** while speaking loudly into the mic so that the indicator remains *off*.

HI, **MID** and **LOW** controls provide independent tone control for each of the **MICS**.

The **EFFECTS** switch engages the **MIC EFFECTS** loop. As stated above, if an external connection is not made to the **RETURN** jack, the **MIC EFFECTS** switch has no effect.

The **ON** switch routes the Mic signal to both **MASTER HOUSE** and **BOOTH**. In the **ON** position, the blue indicator lights and the **BOOTH** level attenuates 12 dB.

LIGHT TRIGGER OUTPUT

The **LIGHT TRIGGER OUTPUT** is a mono balanced output on a 1/4" TRS jack. The output **LEVEL** range of the screwdriver adjustment is off to +6 dB. This Output drives a lighting control box or any other equipment requiring a mono **MASTER** signal. Maximum Output signal level on this jack is +20 dBu.



POWER

The IEC appliance input jack is connected to AC mains using a line cord appropriate for your area. The high efficiency switching power supply used in the **MP 44** operates at voltages from 85 VAC to 250 VAC, 50 or 60 Hz. To prevent accidental shutoff during the height of the show, there is no front panel power switch. When applying power to the system, remember to turn power amplifiers on *last*.

WARNING: DO NOT OPERATE THIS UNIT WITHOUT THE LINE CORD EARTH GROUND CONNECTED. TO DO SO MAY INCREASE THE RISK OF ELECTRIC SHOCK and INCREASE LINE CORD CONDUCTED EMISSIONS.

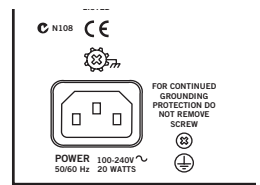

OPTIONAL VR 1 REMOTE LEVEL CONTROL

The **REMOTE LEVEL** input jack is a 3-pin Euroblock connector. If no connection is made, the gain is unaffected. The **Vr** pin provides a precision voltage reference. The **Vc** pin receives the VCA (voltage controlled amplifier) control voltage. The third pin provides a ground reference for the port. To use the VR 1 Remote Control, simply connect like labeled pins together.

To build your own remote control, use a *linear taper* potentiometer with a resistance of 1k Ω to 100k Ω . Connect ground to the **CW** terminal of the potentiometer. Connect **Vc** to the center wiper of the potentiometer. Connect **Vr** to the **CCW** terminal of the potentiometer.

Another option is to use an external, *ground referenced control voltage* with a range of 0 to +5 volts. The gain control law is 125 mV/dB (for each 125 mV applied to the **Vc** pin, the audio is attenuated by 1 dB).

The best option might be to use Rane's ready-to-go remote, the VR 1.

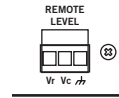

VR 1 REMOTE MOUNTING

The VR 1 remote assembly mounts in a standard U.S. electrical box with a minimum depth of 2.25" (5.5 cm). Be sure to note the wire color of each input in order to facilitate correct wiring to the MP 44. Connect each wire to the 3-pin connector by fully inserting it in the correct socket and tightening the screw. Use the flat head #6 screws supplied with the kit to mount the remote assembly and silk-screened front panel to the electrical box. Note the "UP" arrow screened on the printed circuit board of each remote (mount it pointing *up*).

The silk-screened front panel metal is painted on both sides. This allows you to custom silk-screen the panel or add your own custom decals. Simply install the modified front panel with your art facing out, and you are in business!

Install the knob so that the line on the knob is properly aligned with the silk-screening on the front panel of the remote. Install any Decora plate of your choice. For a secured installation, you may wish to leave the knobs off and use a blank Decora plate to cover the remote after adjustment.

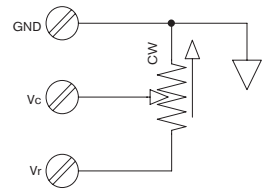

EUROBLOCK CONNECTIONS

When wiring to Euroblocks, a minimum wire gauge of 22 is preferred for reliability. If the ground or shield wire is left shorter, it acts as a strain relief for the other wires. Cable with a flexible jacket is easier to use and less likely to damage the connections. Make sure wires are free of nicks and that the cable jacket is stripped back sufficiently to allow it to lie in the electrical box with the remote assembly inserted, though avoid stripping excess insulation.

You may use 3-conductor unshielded remote control signal cable for shorter runs (less than 200 ft.) or 4-conductor (2 pair) shielded remote control signal cable (use the shield as the GND return) for longer runs (200 to 1000 ft.). The type of wire required is influenced by your installation and local electrical codes.

REMOTE INSTALLATION

Turn the power to the MP 44 *off* until all connections are made. It is important to ensure that the Remote Ports are not subjected to sustained voltages outside the range of 0 to 5 volts DC or high levels of static. Inputs are protected, however, caution is the better part of... you know. It is a good idea to install the wiring, connect it to the Remote and then make the final connections at the MP 44. Do *not* short the Vref pin to ground. This pin is current limited, however, excess heat is generated in the 5 volt supply if a short occurs. *Never subject the Vref pin to voltages above 5 volts.*

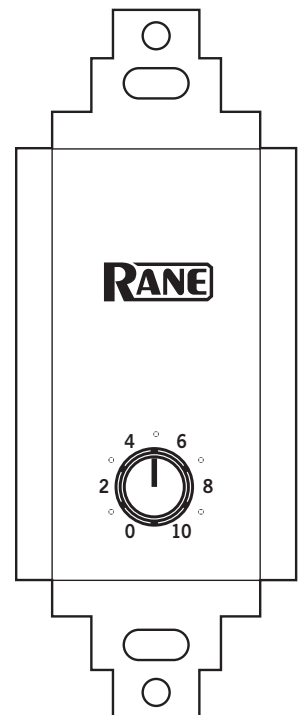

INPUT BLOCK DIAGRAM

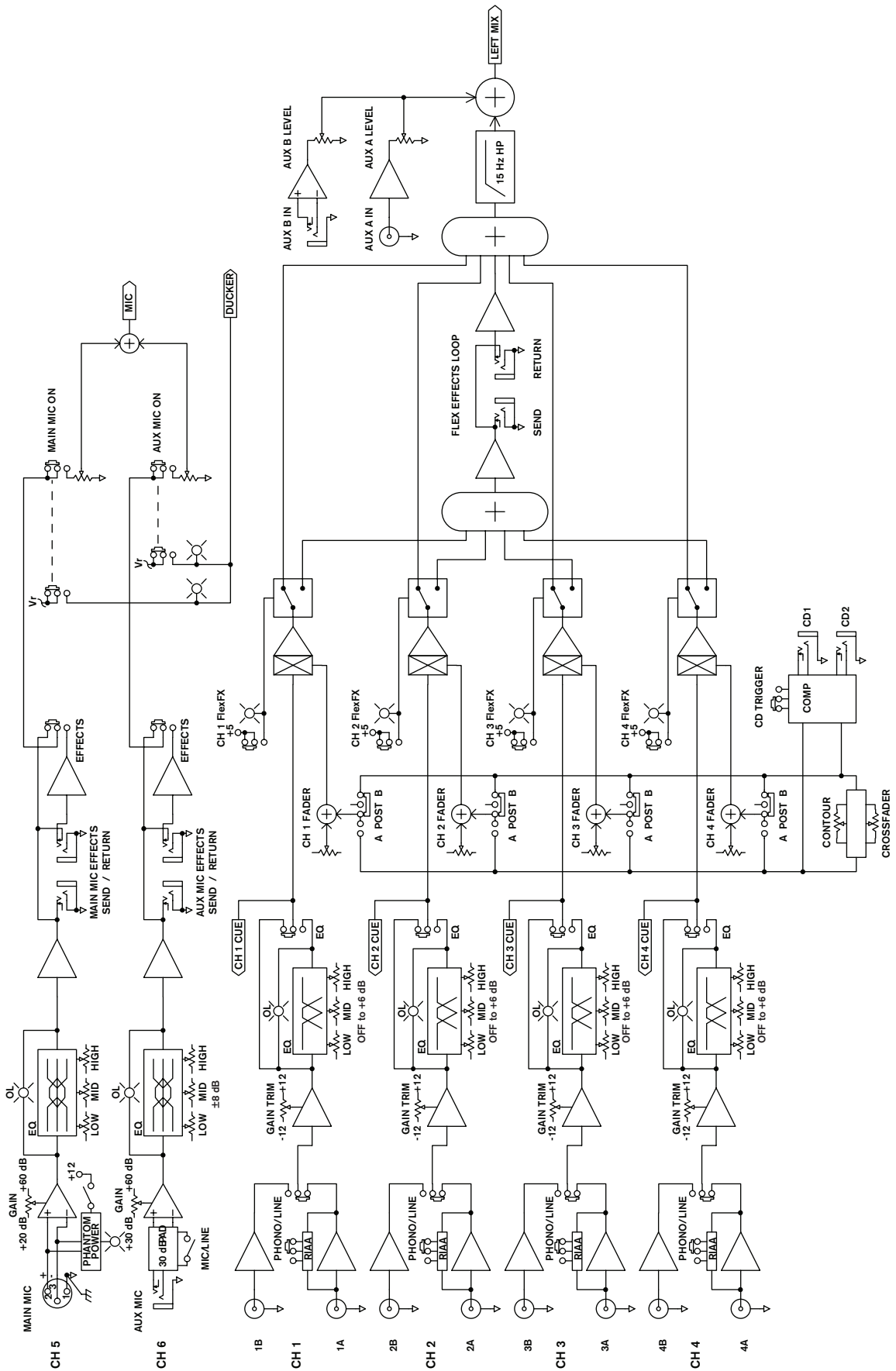

OUTPUT BLOCK DIAGRAM

